

- °Perfiles normalizados de aluminio
- Perfiles de aluminio especiales
- °Disipador-Radiador Térmico de Aluminio
- °disipadores de grandes dimensiones high-dissipation aluminium profiles heat sinks
- °disipador de calor para LED
- °CNC Machining Parts
- °gabinetes para electronica de aluminio
- °Perfiles modulares de aluminio

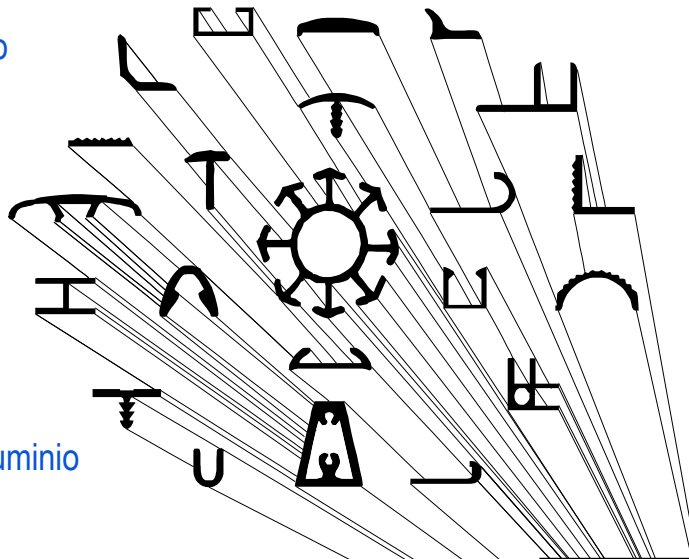

OMAR s.r.l.
PROFILATI ALLUMINIO
ALTA TECNOLOGIA

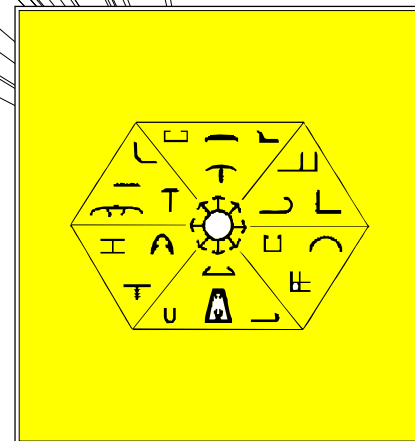

Las "muchas formas" del tocho de aluminio

Perfiles de Aluminio Especiales

Edición Septiembre 2024

Consulta el catálogo actualizado online en:

- www.omar-alluminio.it
- www.omar-alluminio.com
- www.omar-alluminio.eu

- °Perfiles para neumática
- °Perfiles de stand
- °Perfiles para rodapiés cubiertas de alambre para rodapiés
- °Productos derivados de perfiles de aluminio
- °Mecanizado perfiles de aluminio



Via Newton, n.12
20016 Pero (Milano - Italy)
Tel.+39 02 3535955 r.a.
Fax.+39 02 3539929
E.Mail: info@omar-alluminio.it

PERFILES DE ALUMINIO
 POR DIBUJO-ESTÁNDAR-ESPECIAL



ED: ELECTRÓNICA-LED-FOTOVOLTAICA
 AUTOMATIZACIÓN-ROBÓTICA-NEUMÁTICA-AUTOMOCIÓN

Perfiles especiales- Secciones de perfiles de aluminio a medida



DIBUJOS DE VIDA (1:1) - ESCALA 1:1

Via Newton, n.12
20016 Pero (Milano - Italy)
Tel. +39 02 3535955 r.a. Fax. +39 02 3539929
E.Mail: info@omar-alluminio.it

Cataloghi Online: www.omar-alluminio.it
www.omar-alluminio.com
PERFILES DE ALUMINIO A MEDIDA / ESTÁNDAR / ESPECIAL / Y PARA:
ELECTRÓNICA / LED / FOTOVOLTAICA / AUTOMATIZACIÓN ROBOTICA / NEUMÁTICA / AUTOMOCIÓN



1303

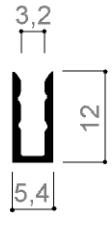

1300

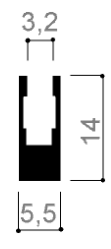

1306

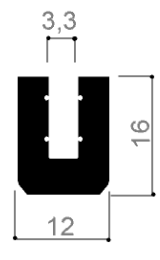

1333

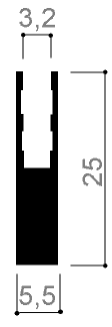

1312

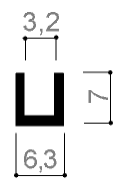

1315

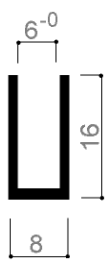

1326

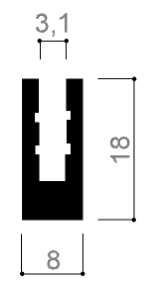

1309

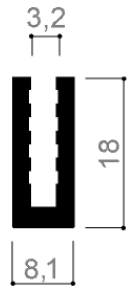

1322

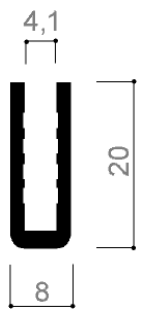

1324

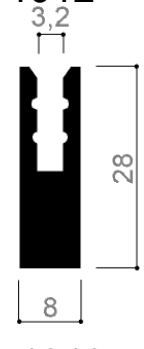

1313

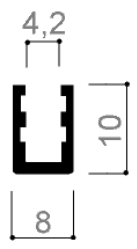

1302
OX ORO

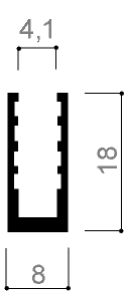

1321

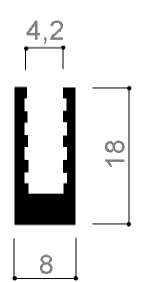

1308



1338

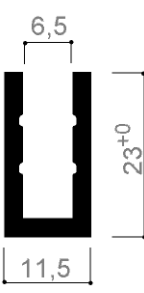

1325

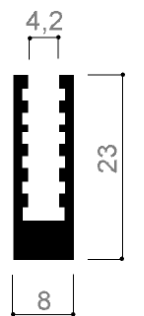

1323

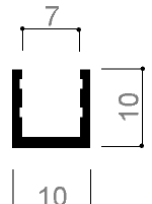

1328

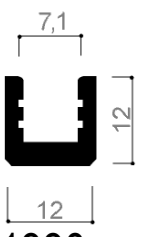

1330

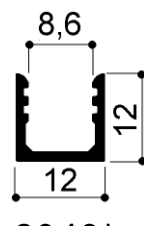

2048*

*PERFIL RESERVADO

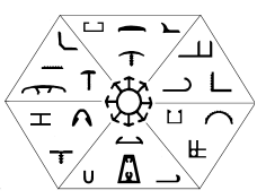

· INCLUSO EN CANTIDADES MODESTAS SE PUEDEN SUMINISTRAR
· DESPUÉS DE LA PREPARACIÓN DE LA MATRIZ, OTROS PERFILES
SEGÚN EL TUYO. PRESUPUESTO

Perfiles correderos y de aluminio para vitrinas.



DIBUJOS DE VIDA (1:1)

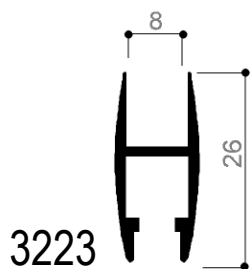

3223

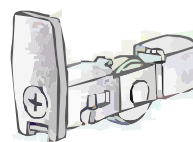
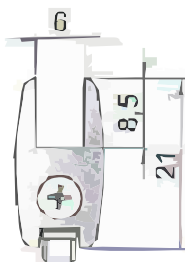

1621/D

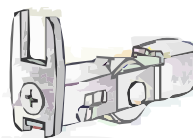

1621/D/F

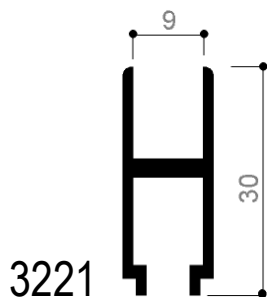

3221

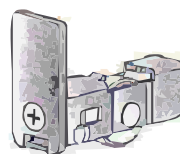
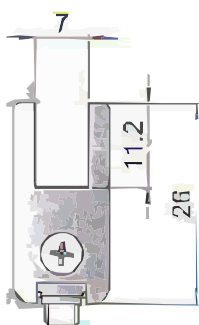
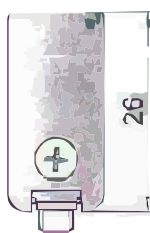

1824/N

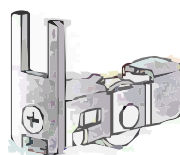

1824/N/F



3162

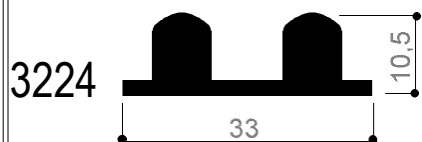

3224



3225

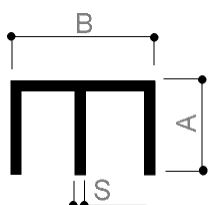

A x B x S
20x15x1
20x18x1,2
20x20x1

3222

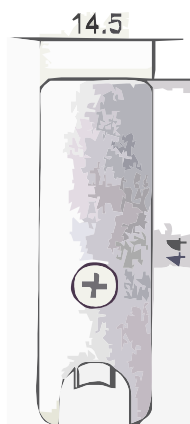
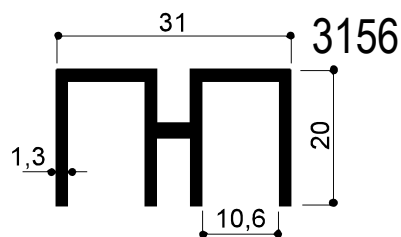
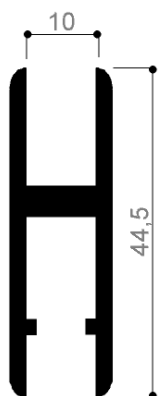

140-03



FOTO DE EJEMPLO: DISIPADOR DE CALOR CON MICRO ALETAS PARA ILUMINACIÓN LED

Via Newton, n.12
20016 Pero (Milano - Italy)
Tel. +39 02 3535955 r.a. Fax. +39 02 3539929
E-Mail: info@omar-alluminio.it

Catálogo Online: www.omar-alluminio.it

www.omar-alluminio.com

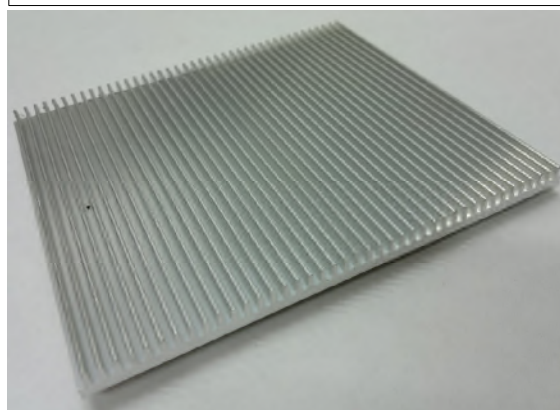
PERFILES DE ALUMINIO A MEDIDA / ESTÁNDAR / ESPECIAL Y PARA:

ELECTRÓNICA / LED / FOTOVOLTAICA / AUTOMATIZACIÓN ROBÓTICA / NEUMÁTICA / AUTOMOCIÓN



Perfiles especiales - Secciones de perfiles de aluminio a medida



DIBUJOS DE VIDA (1:1) - ESCALA 1:1

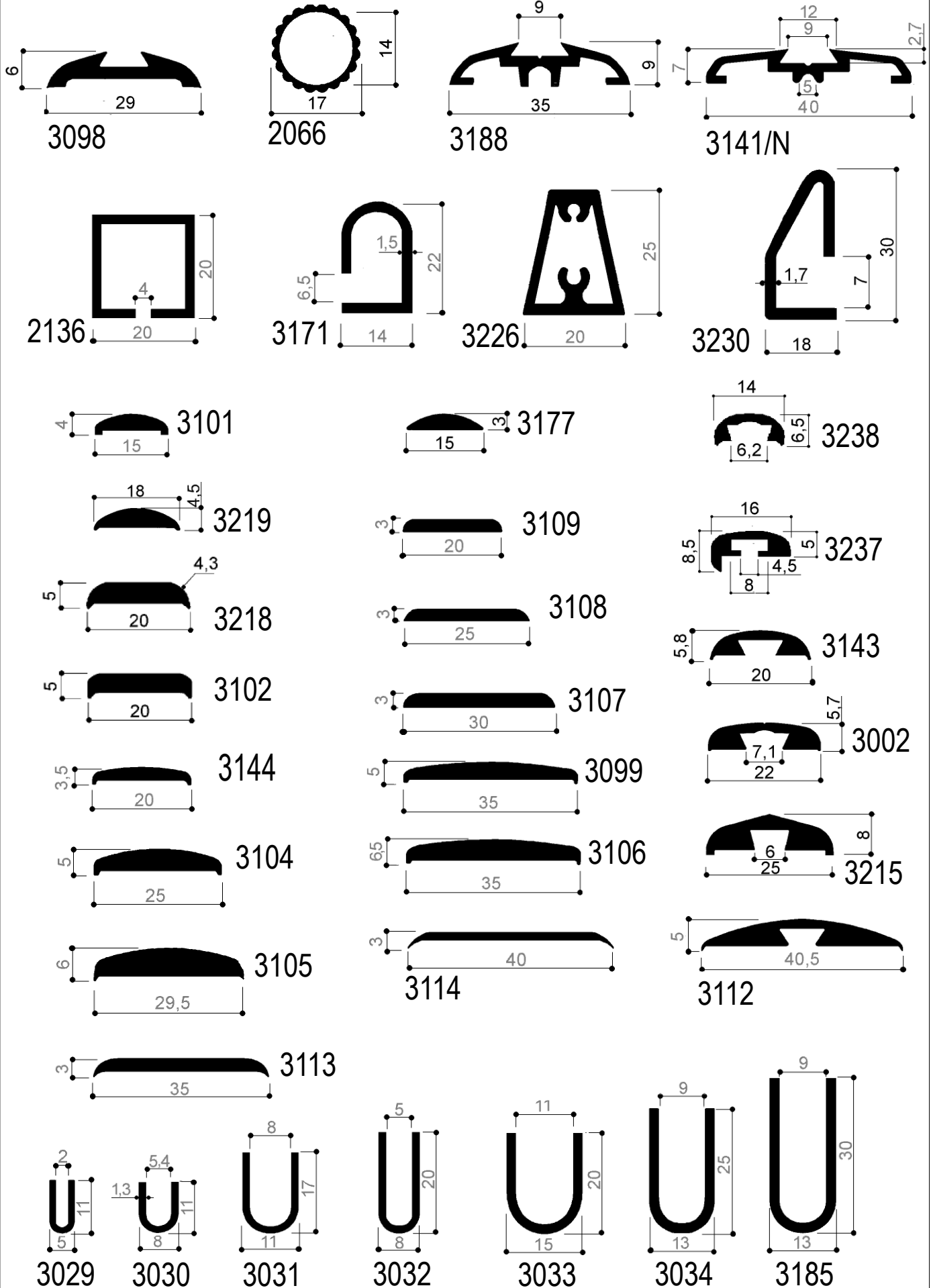

Perfiles especiales - Secciones de perfiles de aluminio a medida



DIBUJOS DE VIDA (1:1) - ESCALA 1:1

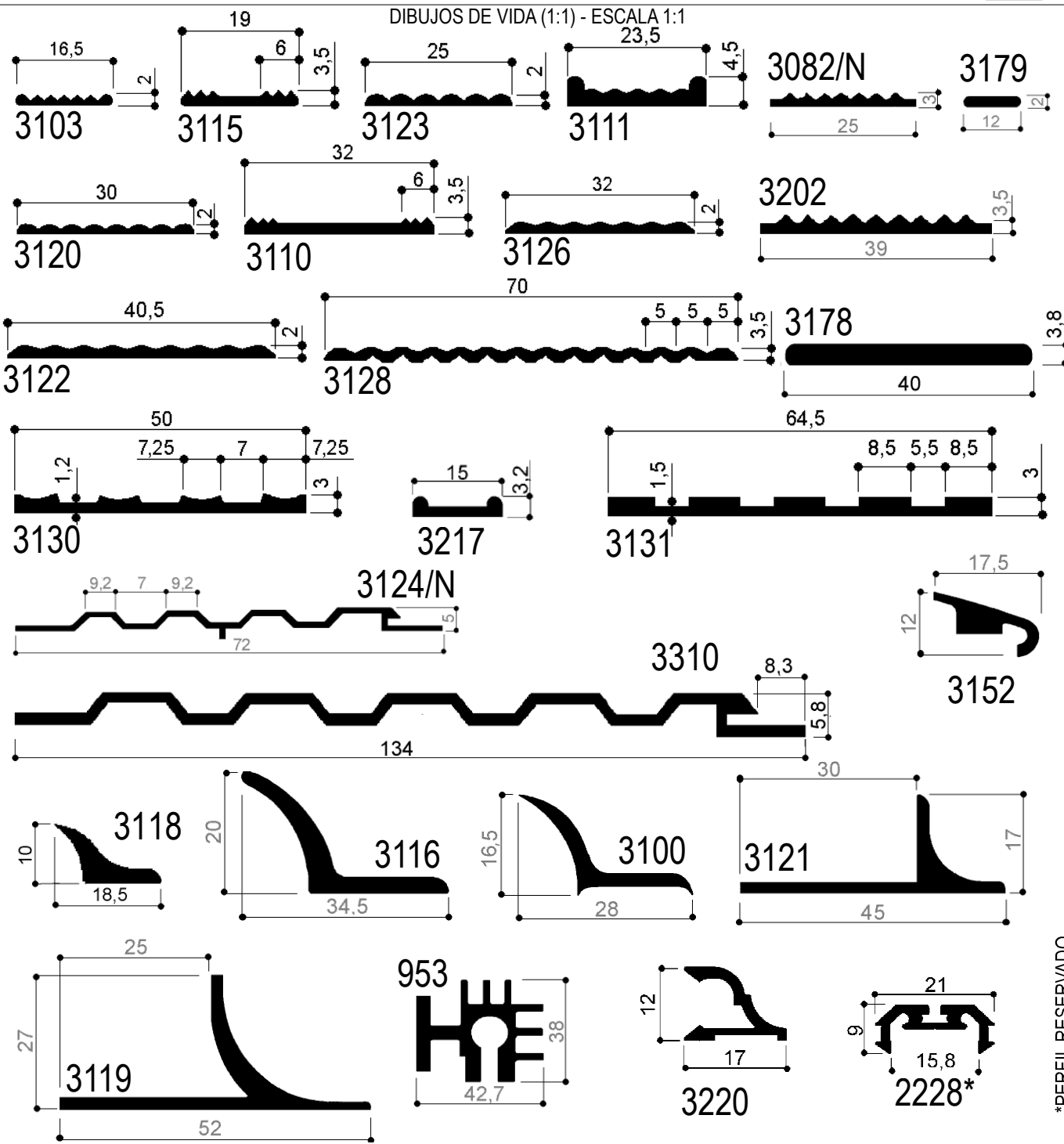

DIBUJOS FUERA DE ESCALA

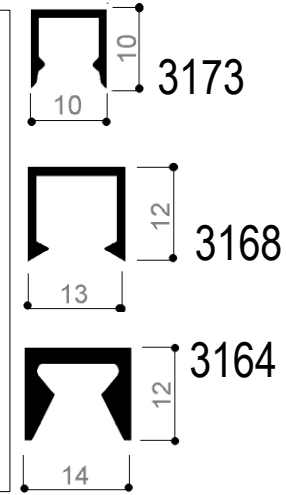
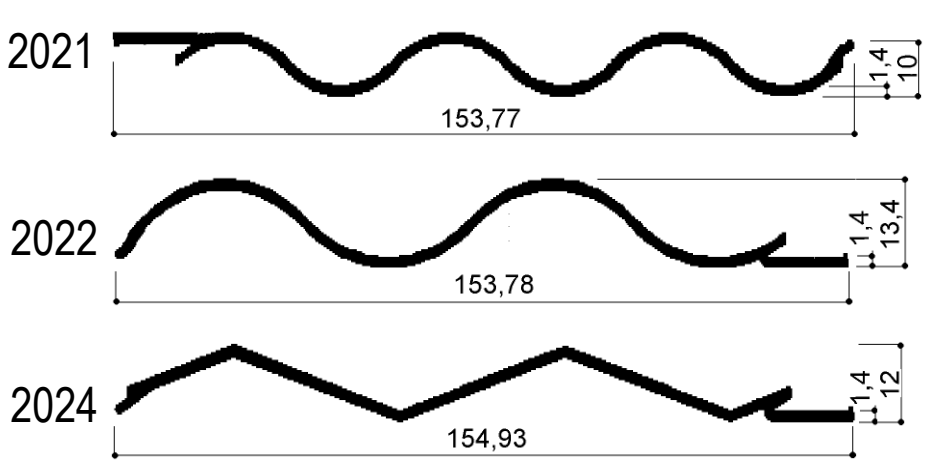

*PERFIL RESERVADO

Via Newton, n.12
20016 Pero (Milano - Italy)
Tel. +39 02 3535955 r.a. Fax. +39 02 3539929
E-Mail: info@omar-alluminio.it

Catálogo Online: www.omar-alluminio.it
www.omar-alluminio.com

PERFILES DE ALUMINIO A MEDIDA / ESTÁNDAR / ESPECIAL / Y PARA:
ELECTRÓNICA / LED / FOTOVOLTAICA / AUTOMATIZACIÓN ROBÓTICA / NEUMÁTICA / AUTOMOCIÓN



Perfiles especiales - Secciones de perfiles de aluminio a medida

DIBUJOS DE VIDA (1:1)



Catálogo Online: www.omar-alluminio.it

www.omar-alluminio.com

PERFILES DE ALUMINIO A MEDIDA / ESTÁNDAR / ESPECIAL / Y PARA:

ELECTRÓNICA / LED / FOTOVOLTAICA / AUTOMATIZACIÓN ROBOTICA / NEUMÁTICA / AUTOMOCIÓN

Via Newton, n.12

20016 Pero (Milano - Italy)

Tel. +39 02 3535955 r.a. Fax. +39 02 3535929

E-Mail: info@omar-alluminio.it

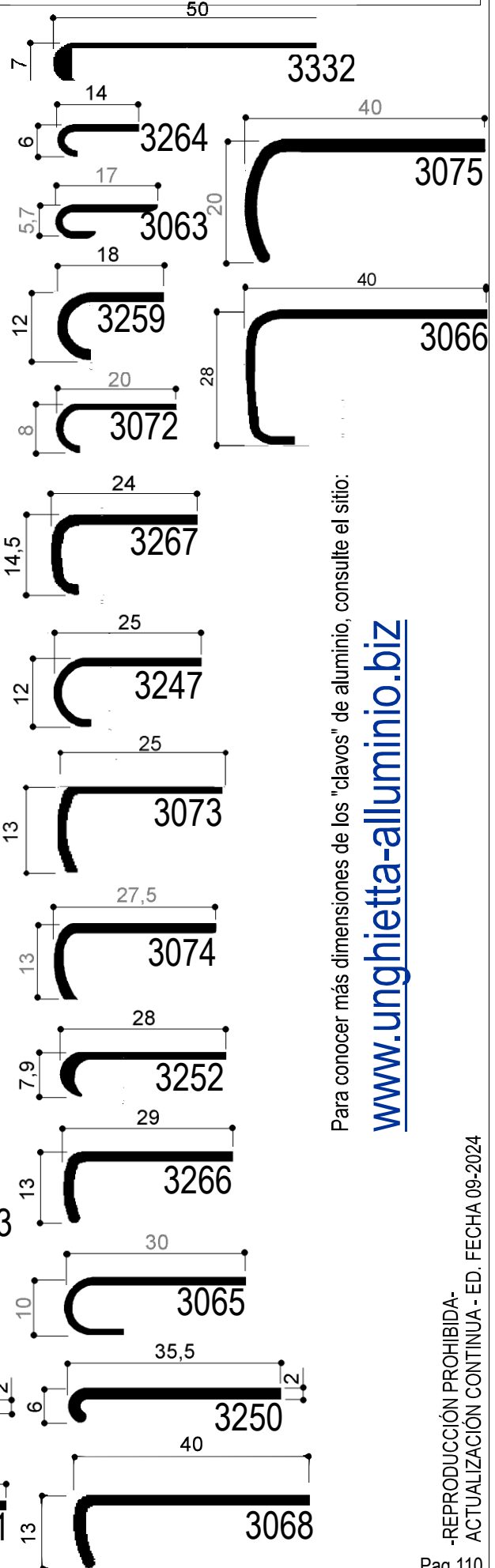
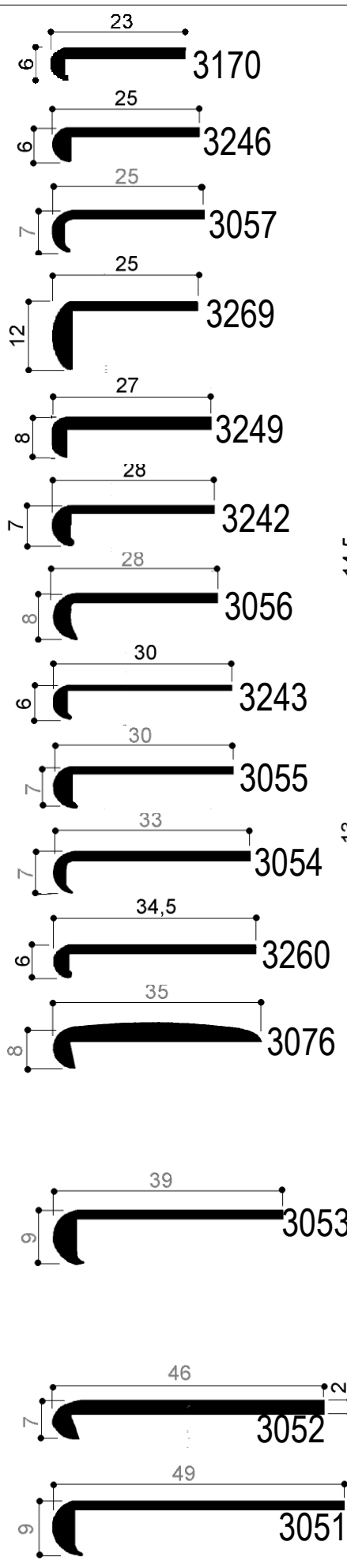
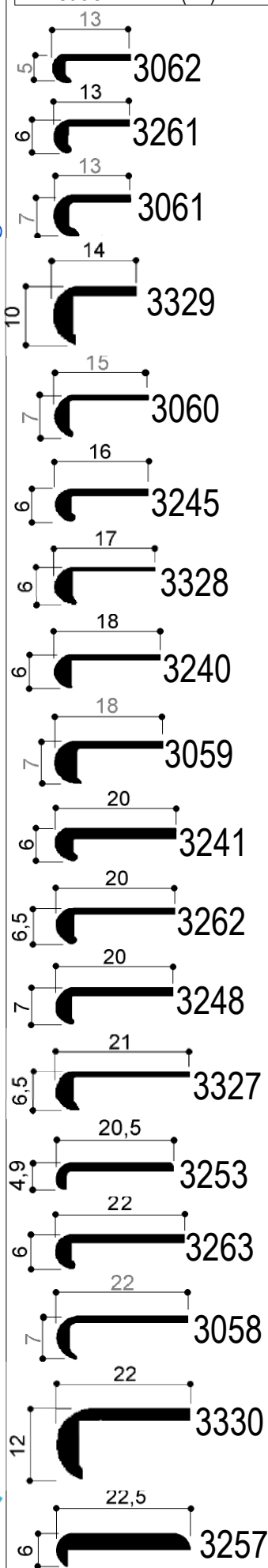

Para conocer más dimensiones de los "clavos" de aluminio, consulte el sitio:

www.unghietta-alluminio.biz

Perfiles especiales - Secciones de perfiles de aluminio a medida



DIBUJOS DE VIDA (1:1) - ESCALA 1:1

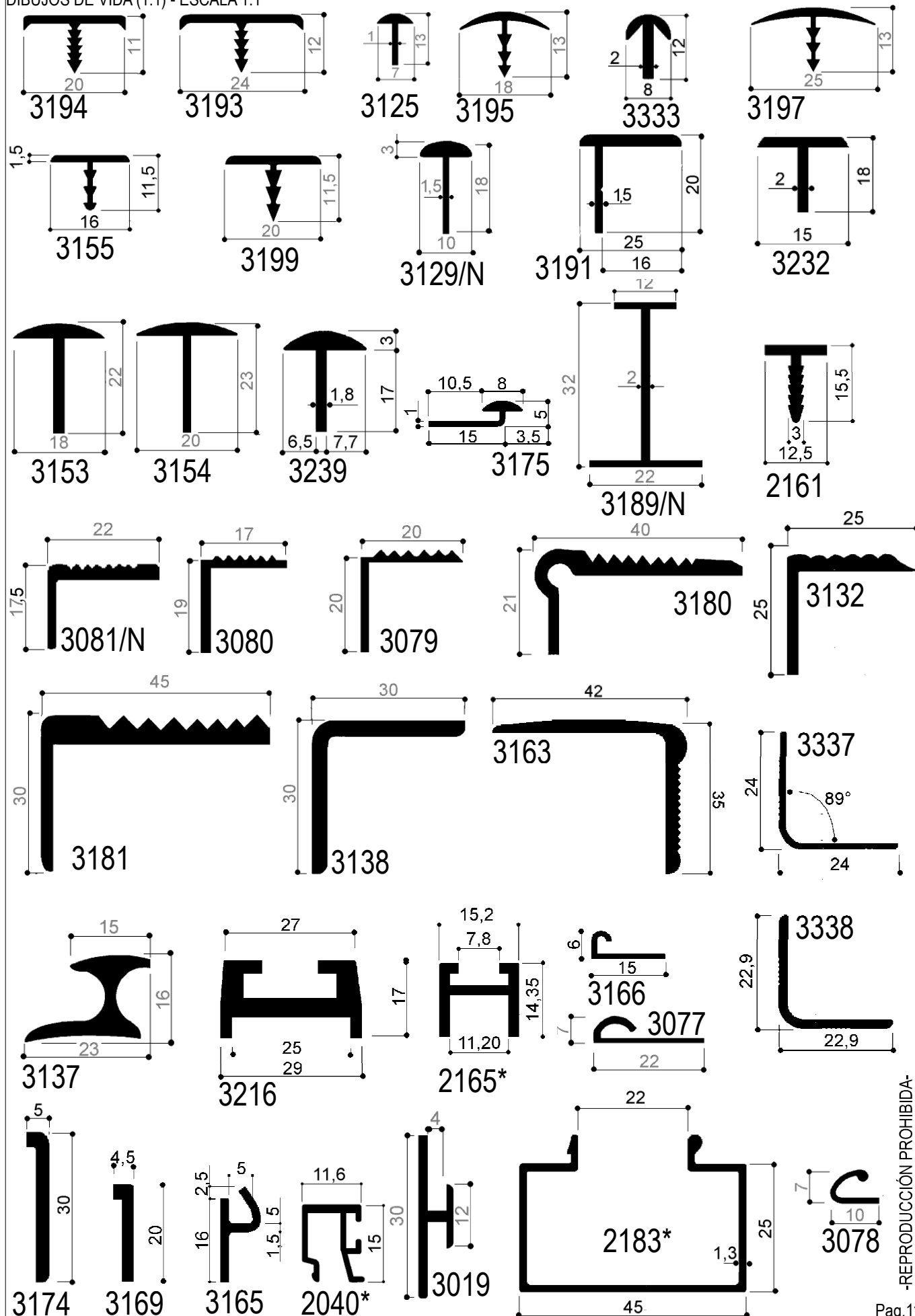

Via Newton, n.12
 20016 Pero (Milano - Italy)
 Tel. +39 02 3535955 r.a. Fax. +39 02 3539929
 E-Mail: info@omar-alluminio.it

Cataloghi Online: www.omar-alluminio.it
www.omar-alluminio.com

PERFILES DE ALUMINIO A MEDIDA / ESTÁNDAR / ESPECIAL / Y PARA:
 ELECTRÓNICA / LED / FOTOVOLTAICA / AUTOMATIZACIÓN ROBÓTICA / NEUMÁTICA / AUTOMOCIÓN

-REPRODUCCIÓN PROHIBIDA-
 ACTUALIZACIÓN CONTINUA - ED. FECHA 09-2024



Perfiles especiales - Secciones de perfiles de aluminio a medida

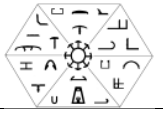

Cataloghi Online: www.omar-alluminio.it
www.omar-alluminio.com

Via Newton, n.12
20016 Pero (Milano - Italy)
Tel. +39 02 3535955 r.a. Fax. +39 02 3539929
E.Mail: info@omar-alluminio.it

PERFILES DE ALUMINIO A MEDIDA / ESTÁNDAR / Y PARA:
ELECTRÓNICA / LED / FOTOVOLTAICA / AUTOMATIZACIÓN ROBOTICA / NEUMÁTICA / AUTOMOCIÓN

OMAR s.r.l.
PROFILATI ALLUMINIO
ALTA TECNOLOGIA

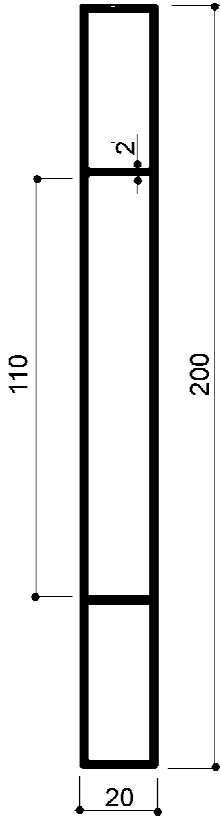

TR200X20/S

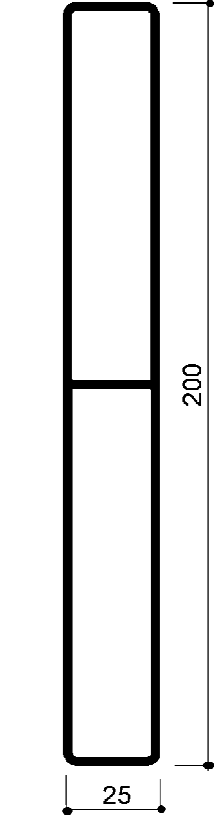

TR200X25/S

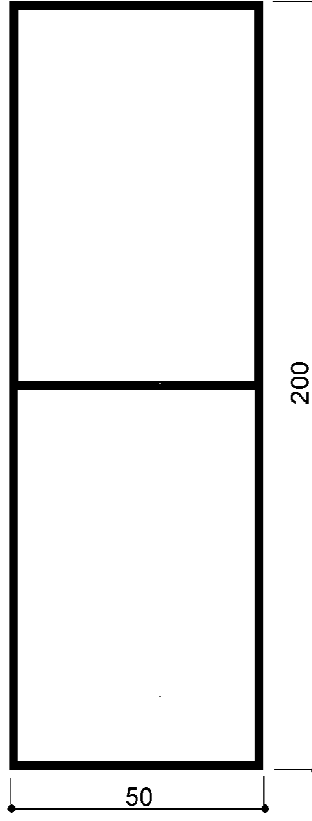

TR200X50/S

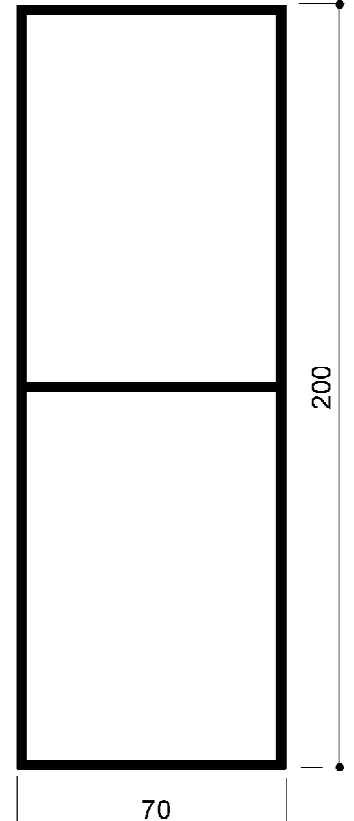

TR200X70/S

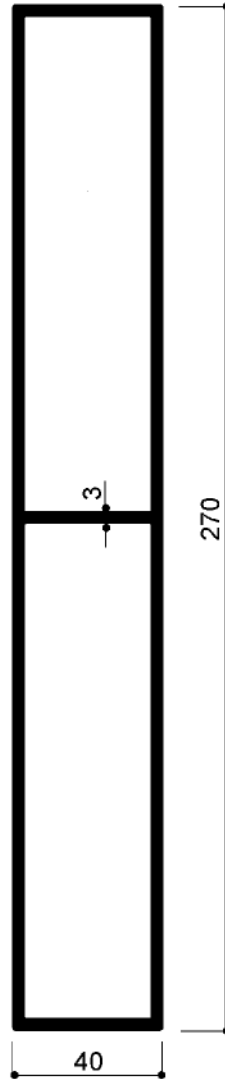

TR270X40/S

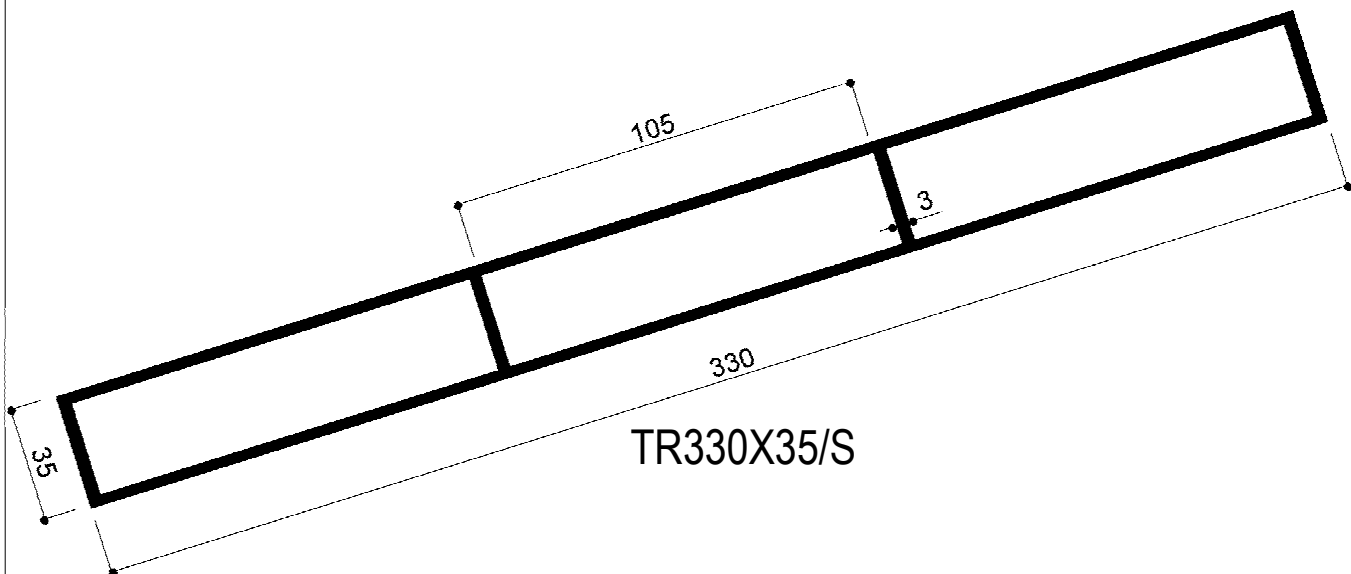
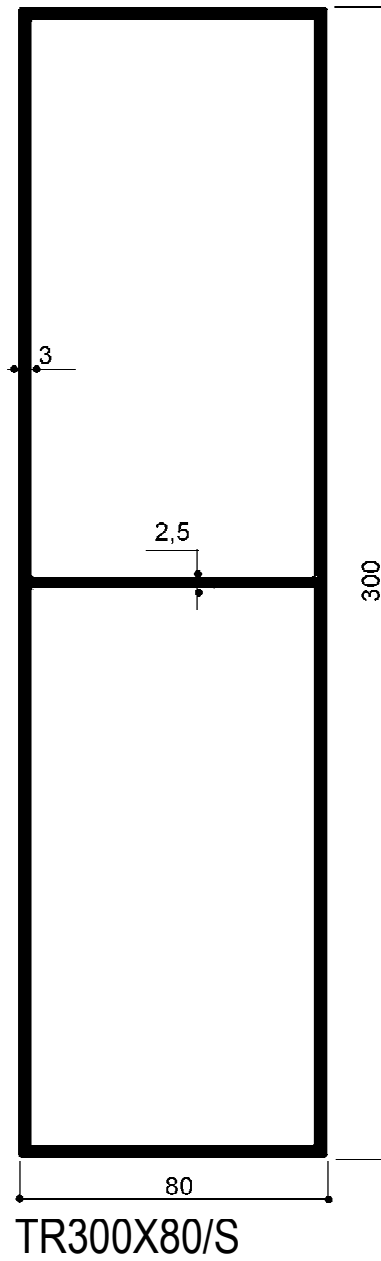
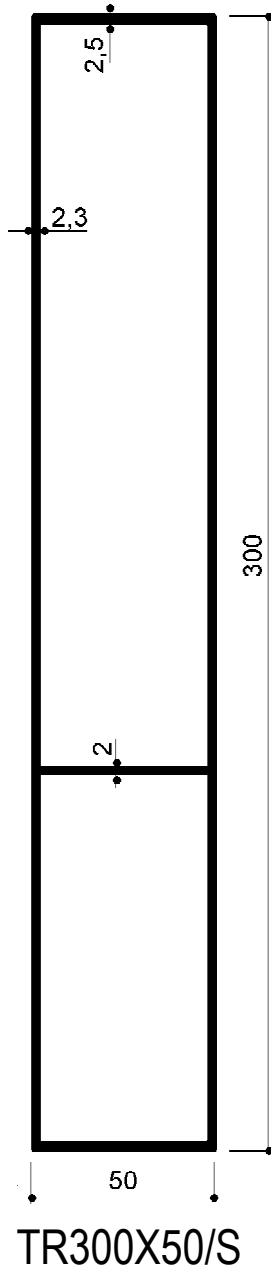
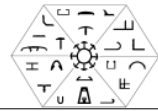

Via Newton, n.12
20016 Pero (Milano - Italy)
Tel. +39 02 3535955 r.a. Fax. +39 02 3539929
E-Mail: info@omar-alluminio.it

Cataloghi Online: www.omar-alluminio.it
www.omar-alluminio.com

PERFILES DE ALUMINIO A MEDIDA / ESTÁNDAR / ESPECIAL / Y PARA:
ELECTRÓNICA / LED / FOTOVOLTAICA / AUTOMATIZACIÓN ROBÓTICA / NEUMÁTICA / AUTOMOCIÓN



Perfiles especiales- Secciones de perfiles de aluminio a medida

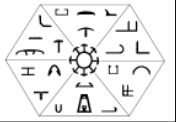

DIBUJOS DE VIDA (1:1) - ESCALA 1:1

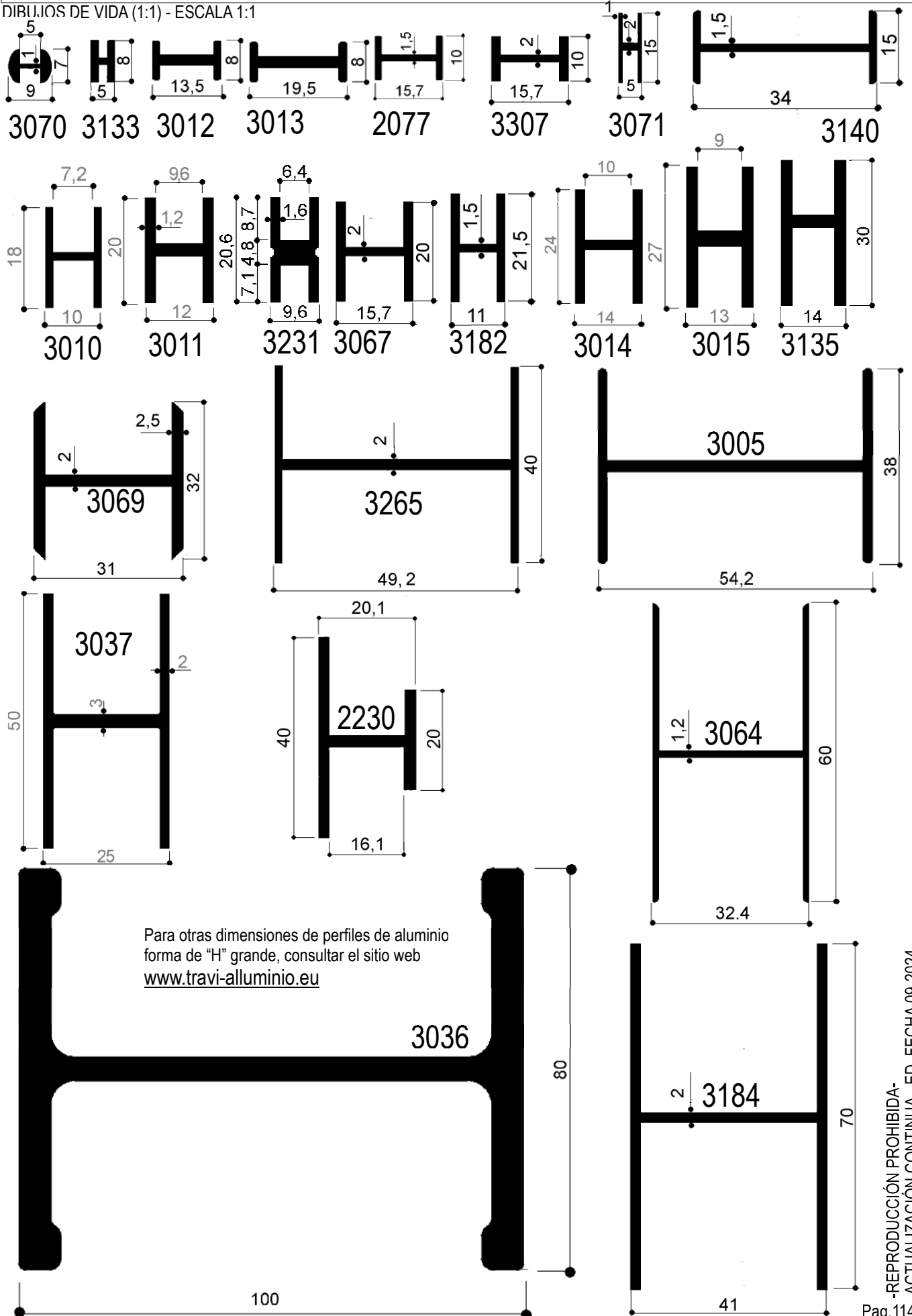

Para otras dimensiones de perfiles de aluminio
forma de "H" grande, consultar el sitio web
www.travi-alluminio.eu

Via Newton, n.12

20016 Pero (Milano - Italy)

Tel. +39 02 3535955 r.a. Fax. +39 02 3535929

E-Mail: info@omar-alluminio.it

Cataloghi Online: www.omar-alluminio.it

www.omar-alluminio.com

PERFILES DE ALUMINIO A MEDIDA / ESTÁNDAR / ESPECIAL / Y PARA:
ELECTRÓNICA / LED / FOTOVOLTAICA / AUTOMATIZACIÓN ROBOTICA / NEUMÁTICA / AUTOMOCIÓN

PERFILES DE ALUMINIO A MEDIDA / ESTÁNDAR / ESPECIAL / Y PARA:
ELECTRÓNICA / LED / FOTOVOLTAICA / AUTOMATIZACIÓN ROBOTICA / NEUMÁTICA / AUTOMOCIÓN

OMAR s.r.l.
PROFILATI ALLUMINIO
ALTA TECNOLOGIA

Perfiles especiales- Secciones de perfiles de aluminio a medida



DIBUJOS DE VIDA (1:1) - ESCALA 1:1

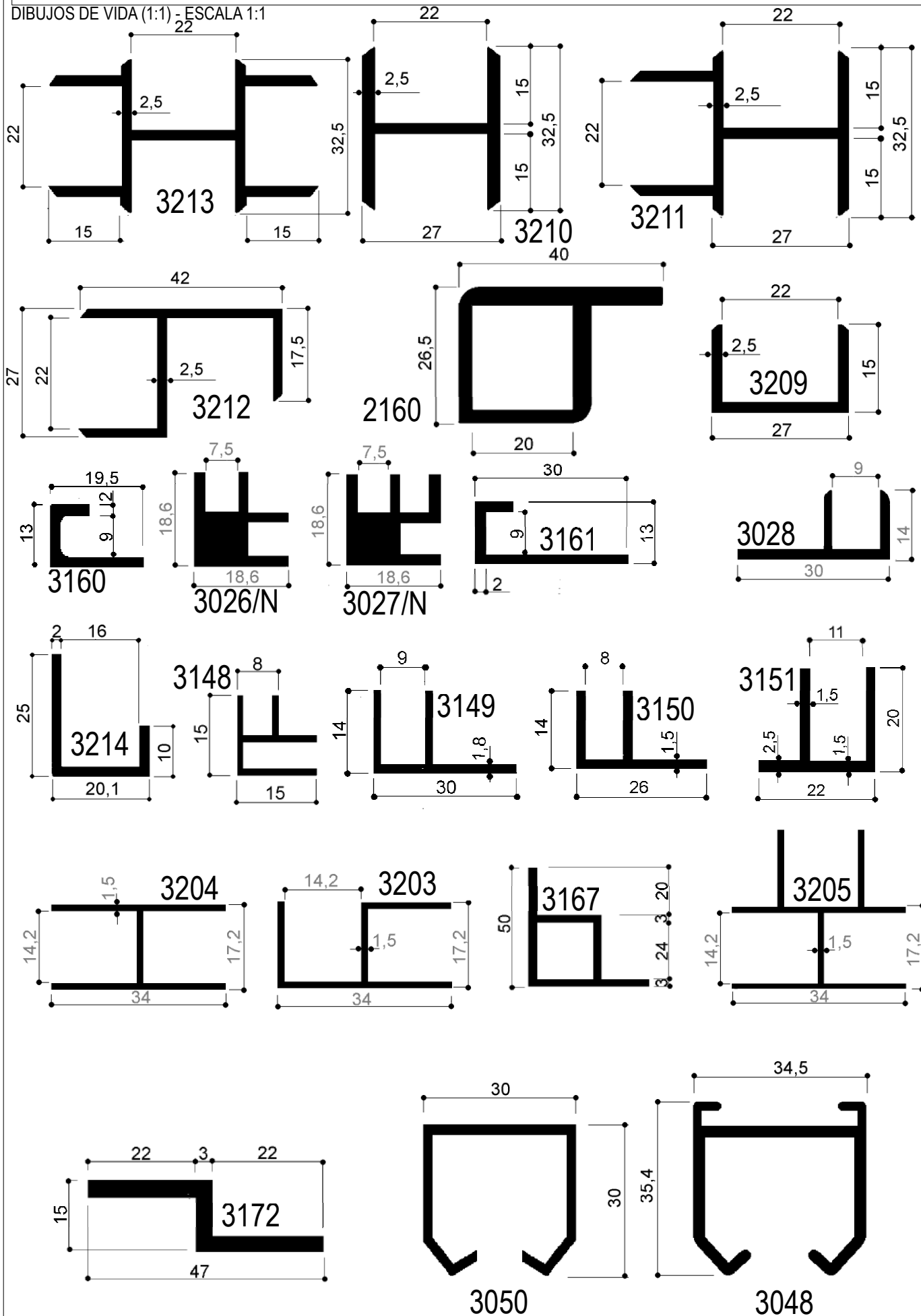

Via Newton, n.12
20016 Pero (Milano - Italy)
Tel. +39 02 3535955 r.a. Fax. +39 02 3539929
E-Mail: info@omar-alluminio.it

Cataloghi Online: www.omar-alluminio.it
www.omar-alluminio.com

PERFILES DE ALUMINIO A MEDIDA / ESTÁNDAR / ESPECIAL / Y PARA:
ELECTRÓNICA / LED / FOTOVOLTAICA / AUTOMATIZACIÓN ROBÓTICA / NEUMÁTICA / AUTOMOCIÓN



Perfiles especiales - Secciones de perfiles de aluminio a medida



Via Newton, n.12
20016 Pero (Milano - Italy)
Tel. +39 02 3535955 r.a. Fax. +39 02 3539929
E.Mail: info@omar-alluminio.it

Cataloghi Online: www.omar-alluminio.it
www.omar-alluminio.com

PERFILES DE ALUMINIO A MEDIDA / ESTÁNDAR / ESPECIAL / Y PARA:
ELECTRÓNICA / LED / FOTOVOLTAICA / AUTOMATIZACIÓN ROBÓTICA / NEUMÁTICA / AUTOMOCIÓN

OMAR s.p.a.
PROFILATI ALLUMINIO
ALTA TECNOLOGIA

DIBUJOS DE VIDA (1:1)

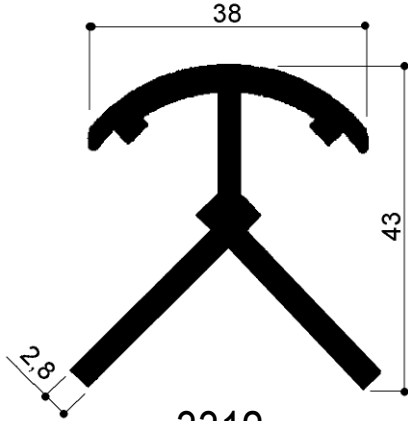

3312

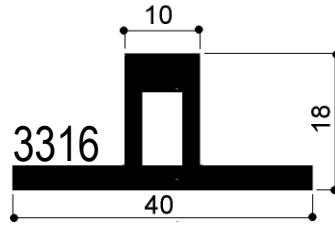

3316

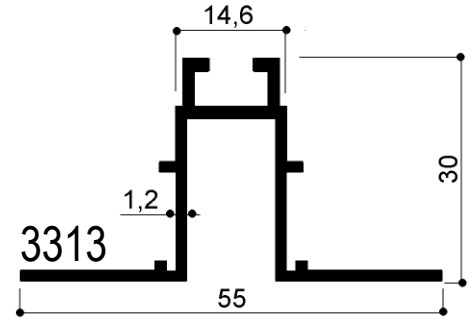

3313

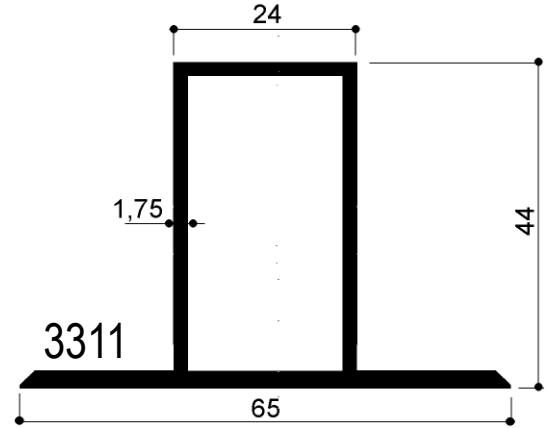

3311

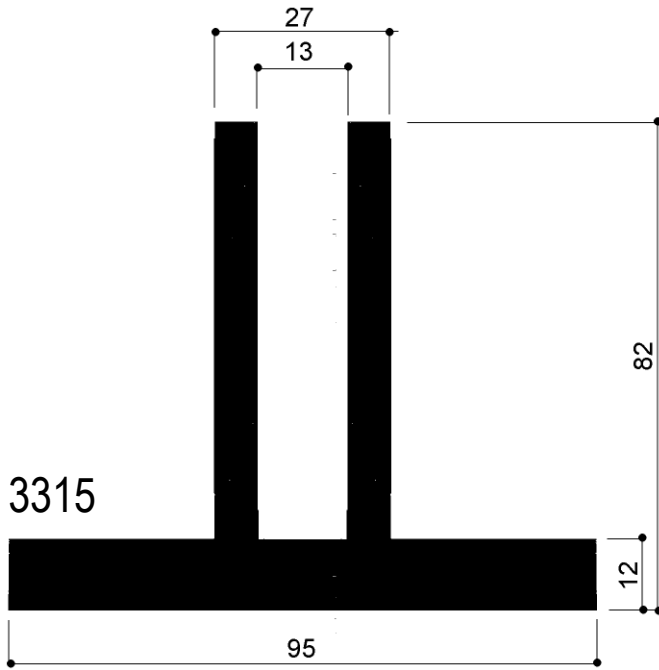

3315

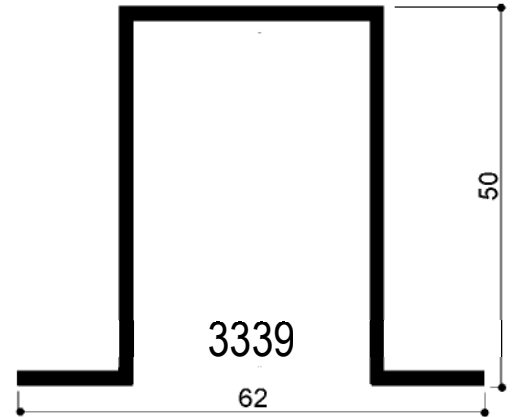

3339

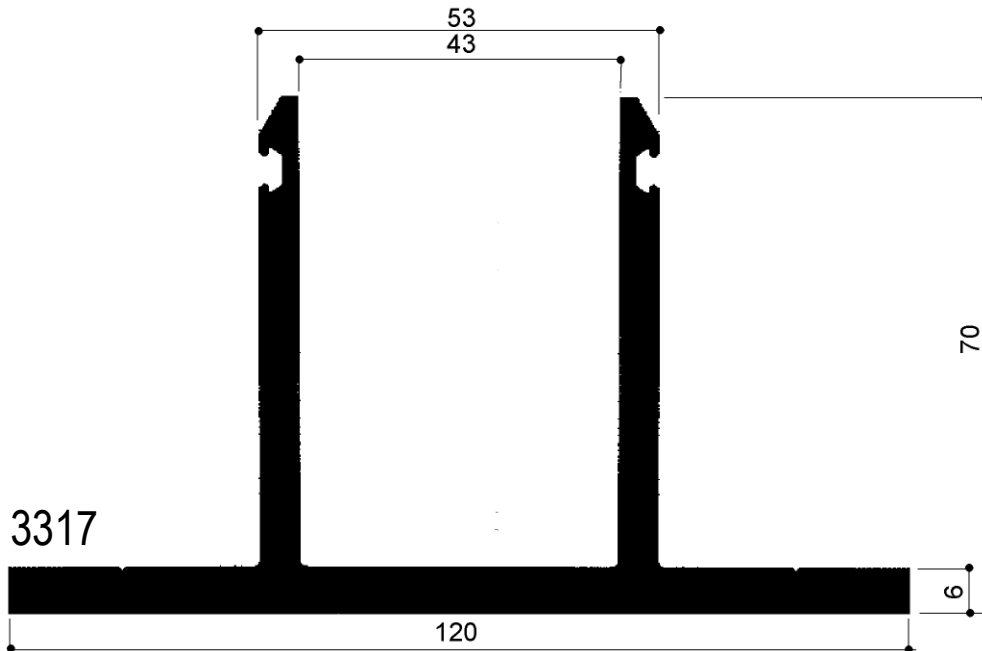

3317

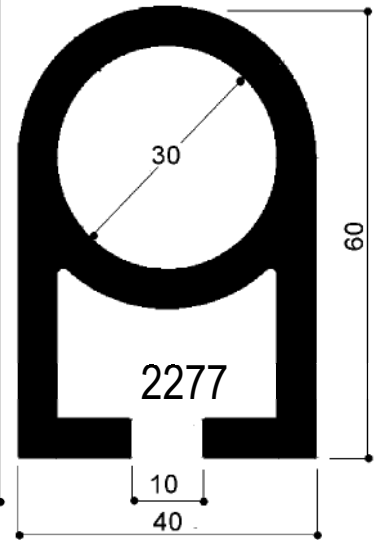

2277

Perfiles especiales- Secciones de perfiles de aluminio a medida

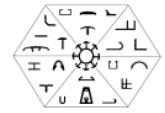

DIBUJOS DE VIDA (1:1)

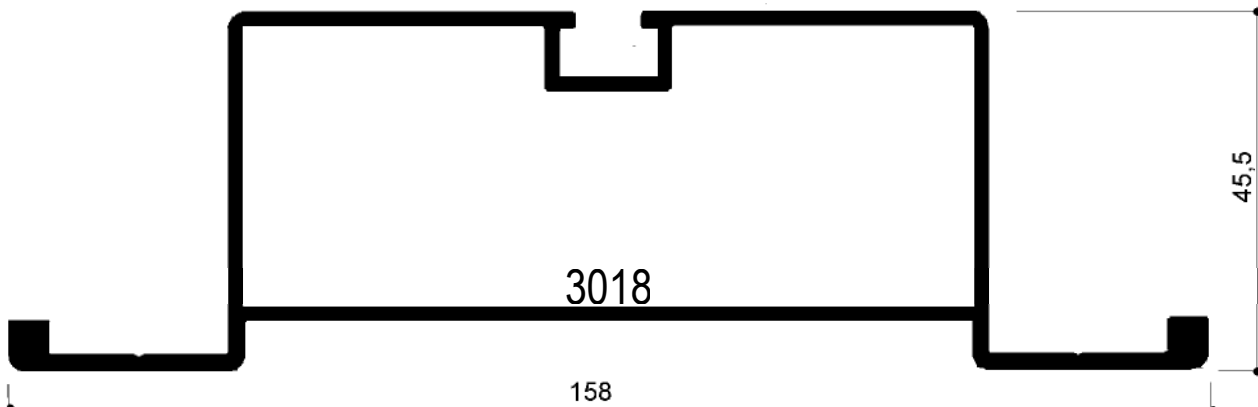
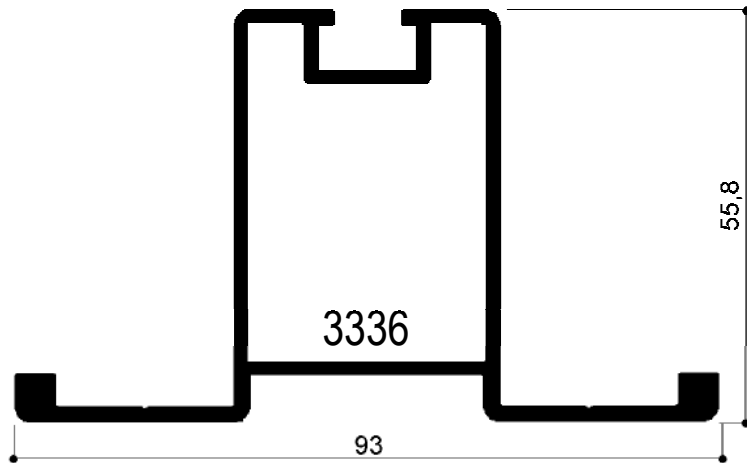
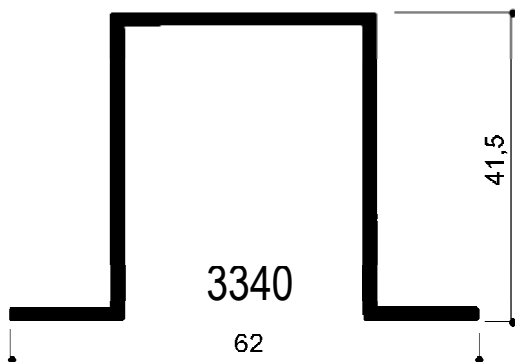
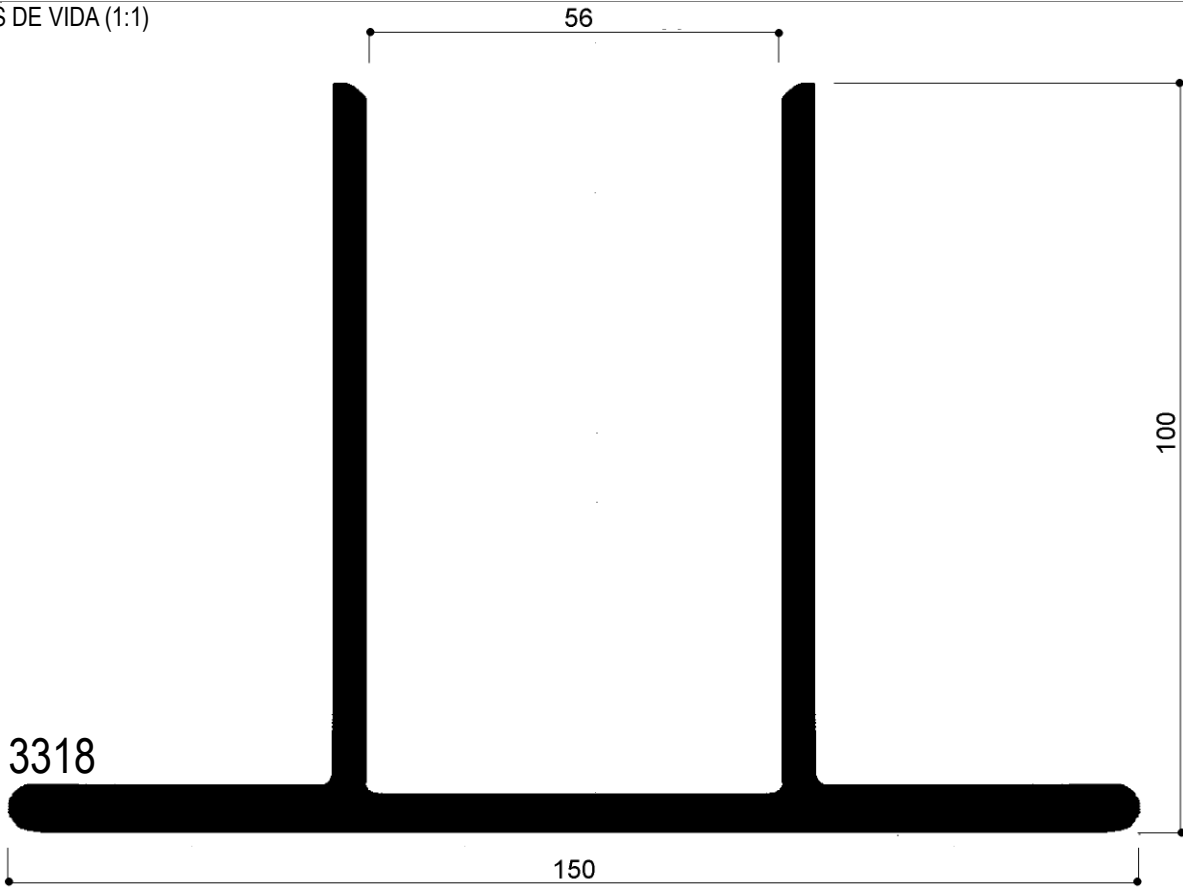

Para más dimensiones de los perfiles de aluminio C consultar el sitio web: www.canalini-alluminio.it

-REPRODUCCIÓN PROHIBIDA -

ACTUALIZACIÓN CONTINUA - ED. FECHA 09-2024

Pag.117

Cataloghi Online: www.omar-alluminio.it

www.omar-alluminio.com

PERFILES DE ALUMINIO A MEDIDA / ESTÁNDAR / ESPECIAL / Y PARA:

ELECTRÓNICA / LED / FOTOVOLTAICA / AUTOMATIZACIÓN ROBÓTICA / NEUMÁTICA / AUTOMOCIÓN

Via Newton, n.12
20016 Pero (Milano - Italy)
Tel. +39 02 3535955 r.a. Fax. +39 02 3539929
E-Mail: info@omar-alluminio.it



Perfiles especiales - Secciones de perfiles de aluminio a medida



DIBUJOS DE VIDA (1:1) - ESCALA 1:1

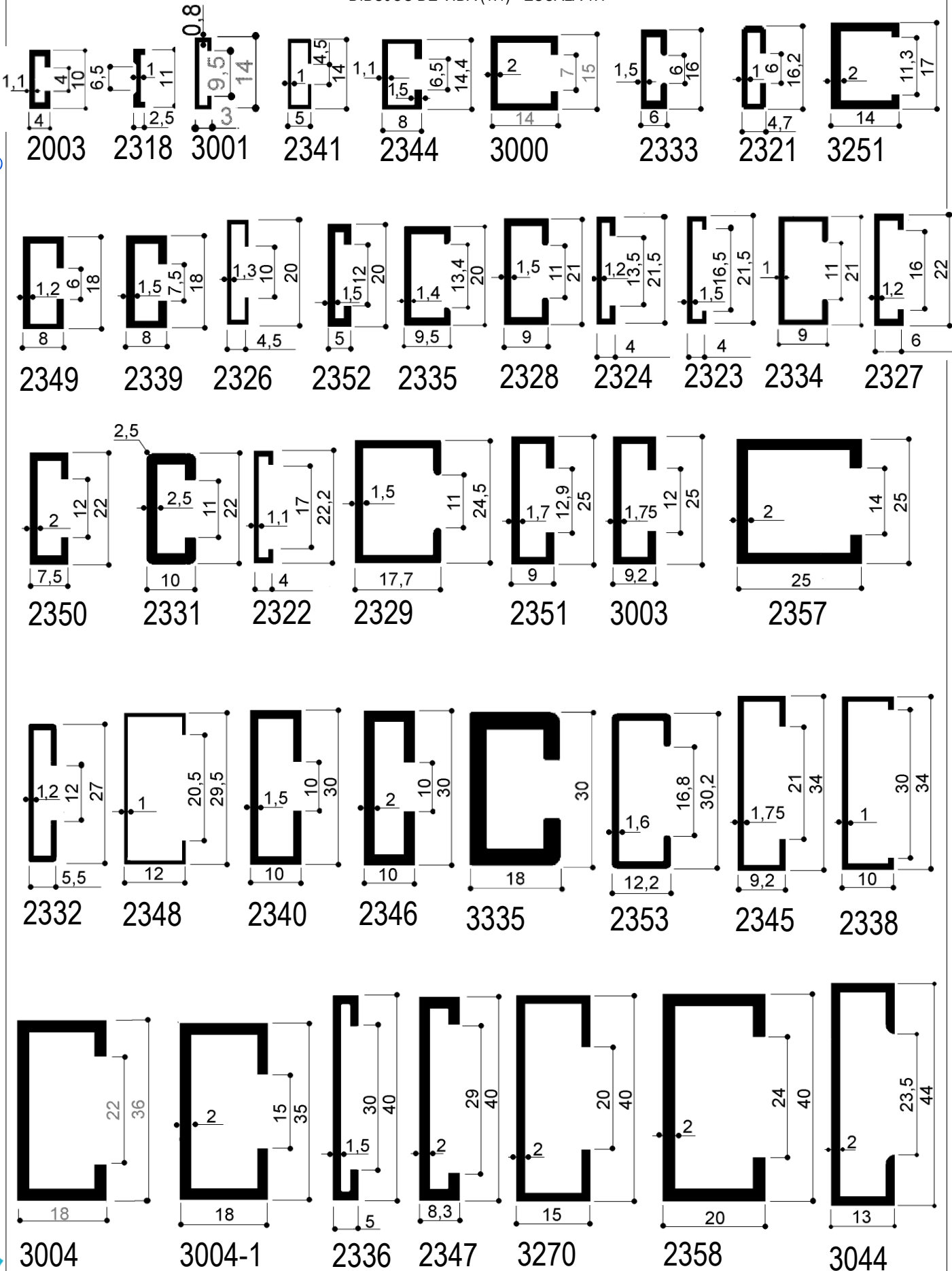

Via Newton, n.12

20016 Pero (Milano - Italy)

Tel. +39 02 3535955 r.a. Fax. +39 02 3539929

E-Mail: info@omar-alluminio.it

Cataloghi Online: www.omar-alluminio.it

www.omar-alluminio.com

PERFILES DE ALUMINIO A MEDIDA / ESTÁNDAR / ESPECIAL / Y PARA:

ELECTRÓNICA / LED / FOTOVOLTAICA / AUTOMATIZACIÓN ROBOTICA / NEUMÁTICA / AUTOMOCIÓN

OMAR s.r.l.
PROFILATI ALLUMINIO
ALTA TECNOLOGIA

Perfiles Especiales - Secciones de perfiles de aluminio a medida

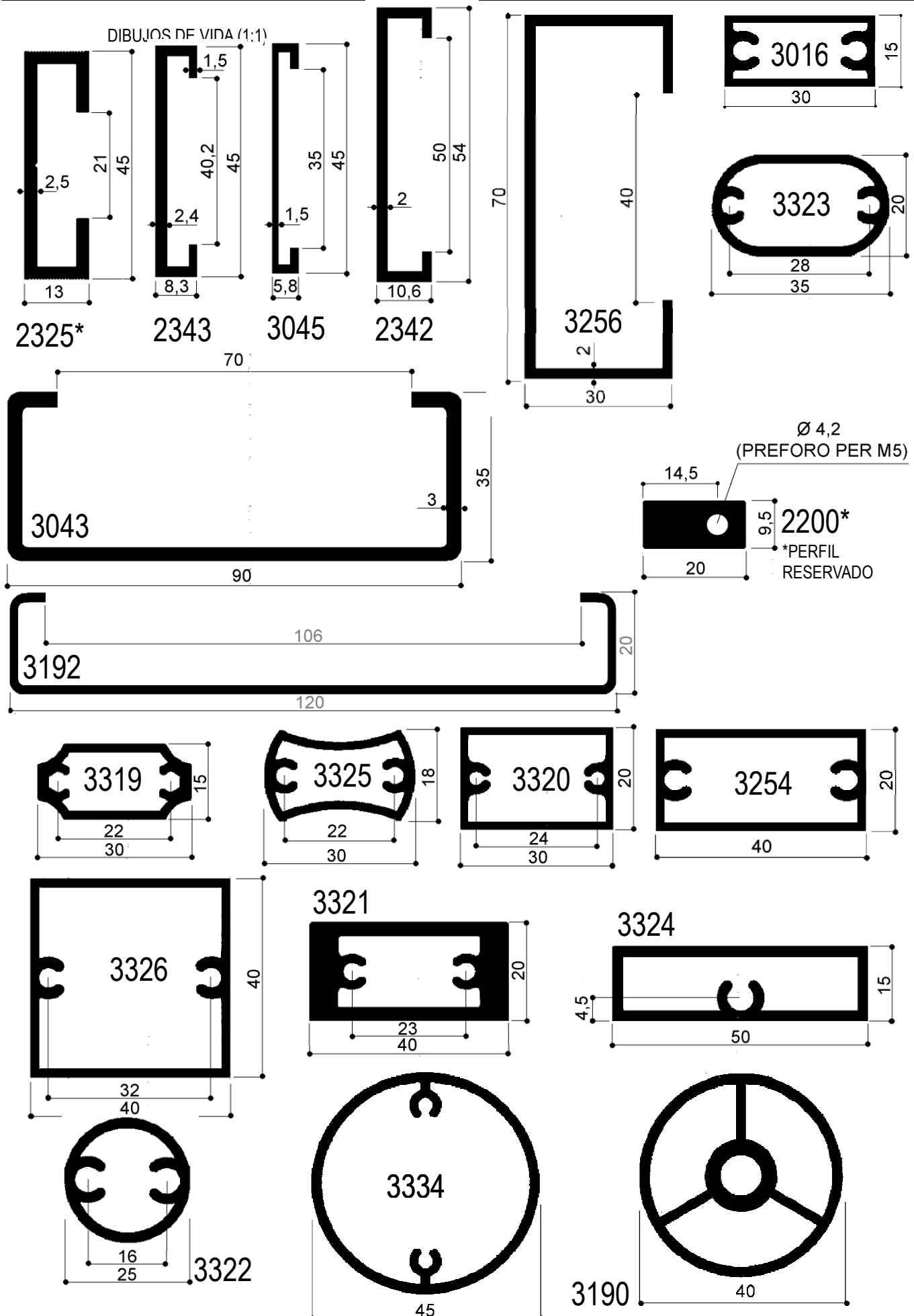
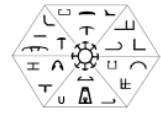

Via Newton, n.12

20016 Pero (Milano - Italy)

Tel. +39 02 3535955 r.a. Fax. +39 02 3539929

E-Mail: info@omar-alluminio.it

Cataloghi Online: www.omar-alluminio.it

www.omar-alluminio.com

PERFILES DE ALUMINIO A MEDIDA / ESTÁNDAR / ESPECIAL / Y PARA:

ELECTRÓNICA / LED / FOTOVOLTAICA / AUTOMATIZACIÓN ROBOTICA / NEUMÁTICA / AUTOMOCIÓN



Perfiles especiales- Secciones de perfiles de aluminio a medida



DIBUJOS DE VIDA (1:1)

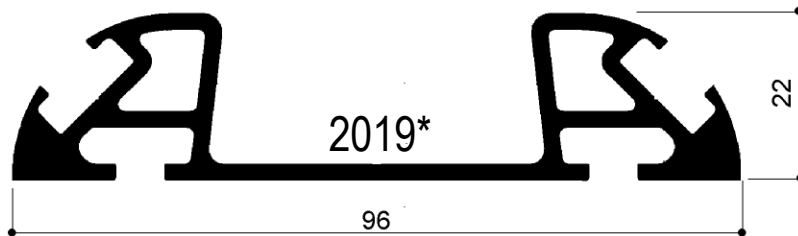
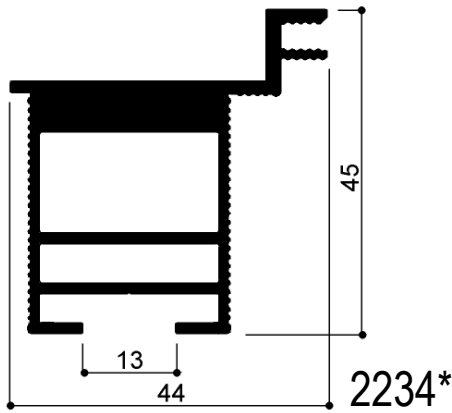
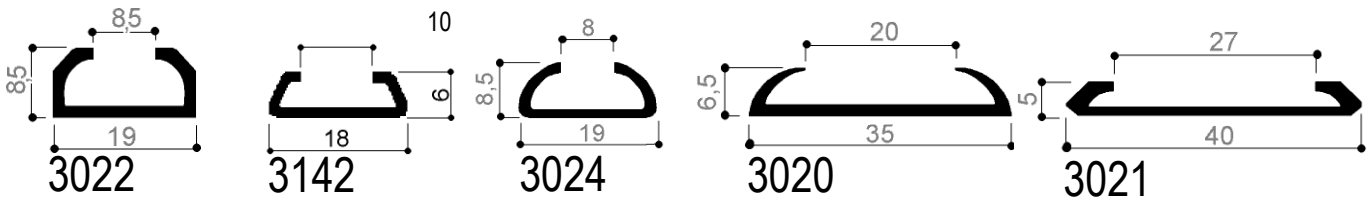
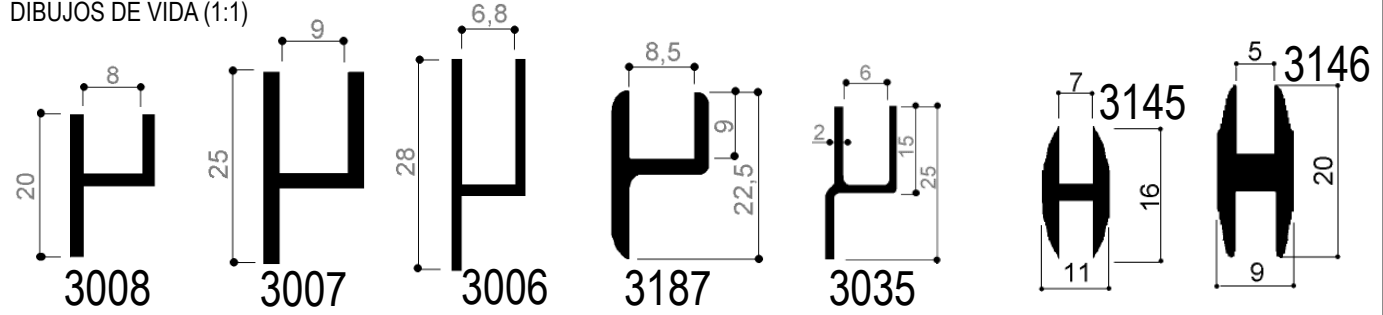

*PERFIL RESERVADO

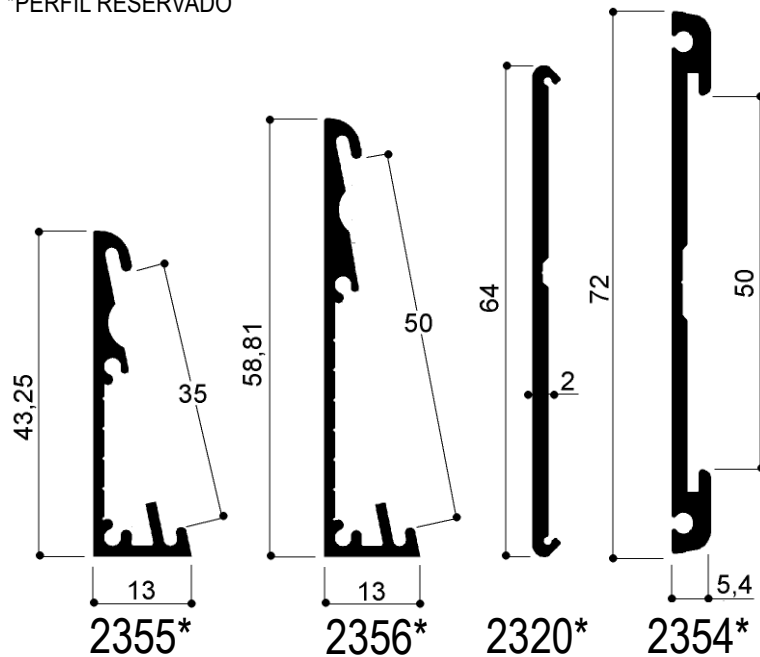
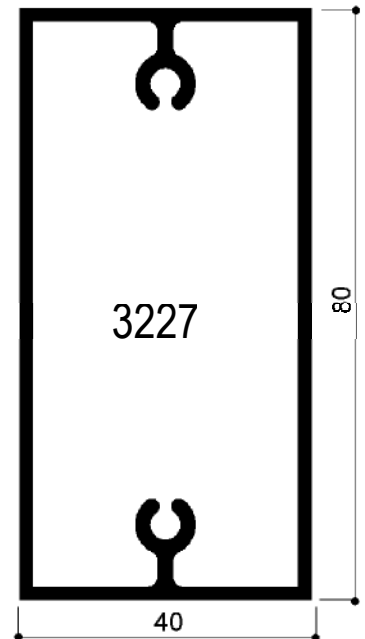
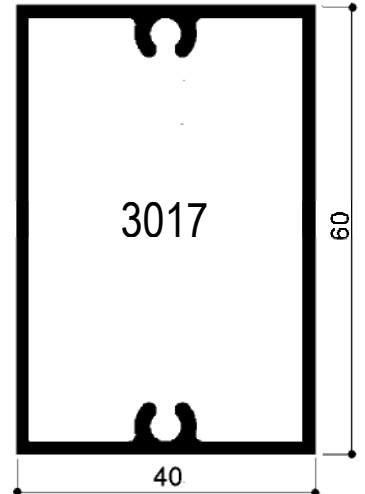

Perfiles Especiales - RACLE -

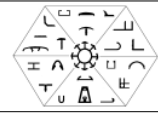

DIBUJOS DE VIDA (1:1)

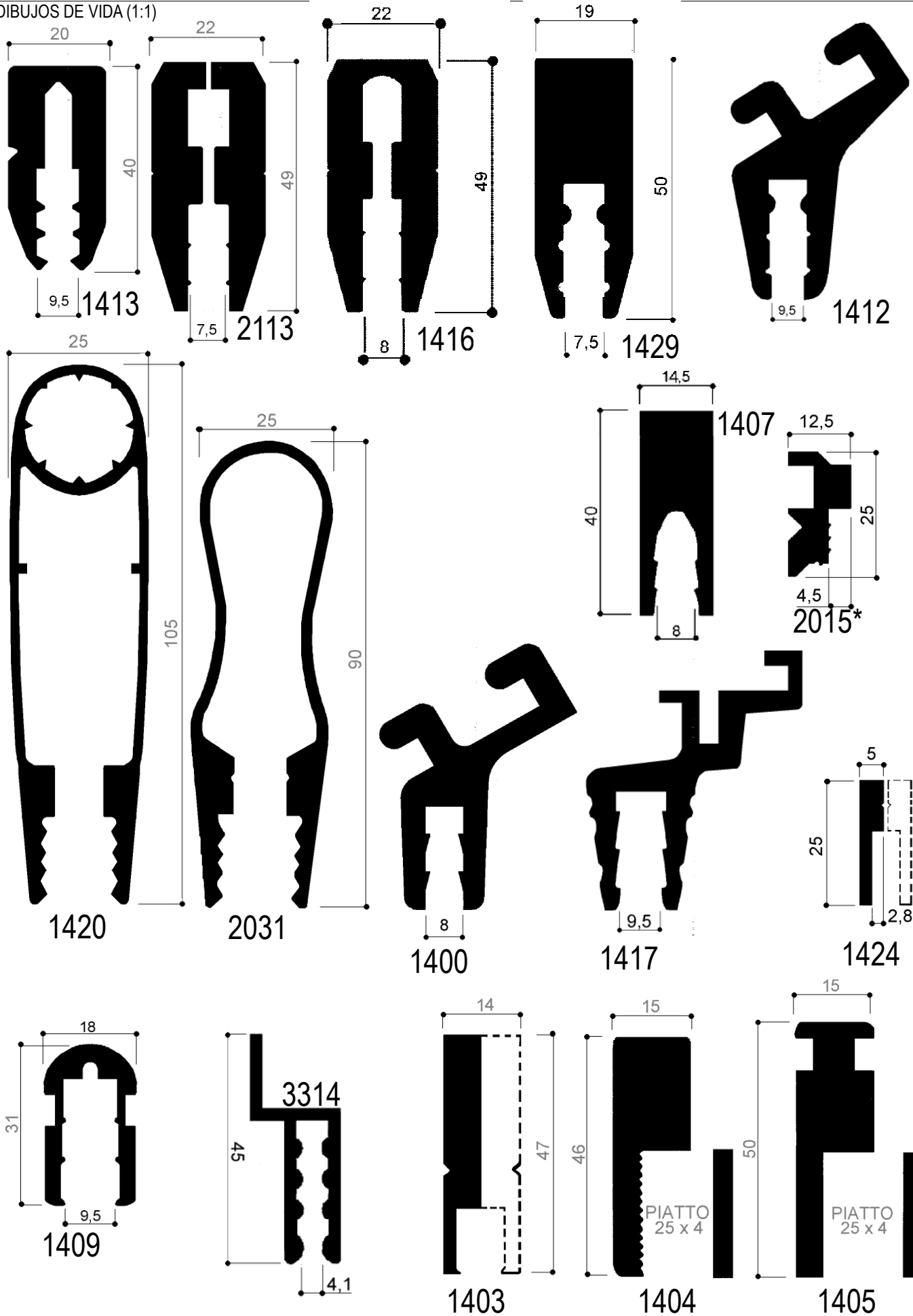



Profili Speciali - RACLE -

DISEGNI AL VERO (1:1)

Cataloghi Online: www.omar-alluminio.it

Via Newton, n. 12

20016 Pero (Milano - Italy)

Tel. +39 02 3535955 r.a. Fax. +39 02 3539929

E. Mail: info@omar-alluminio.it

www.omar-alluminio.com

PERFILES DE ALUMINIO A MEDIDA / ESTÁNDAR / ESPECIAL / Y PARA:

ELECTRÓNICA / LED / FOTOVOLTAICA / AUTOMATIZACIÓN ROBOTICA / NEUMÁTICA / AUTOMOCIÓN

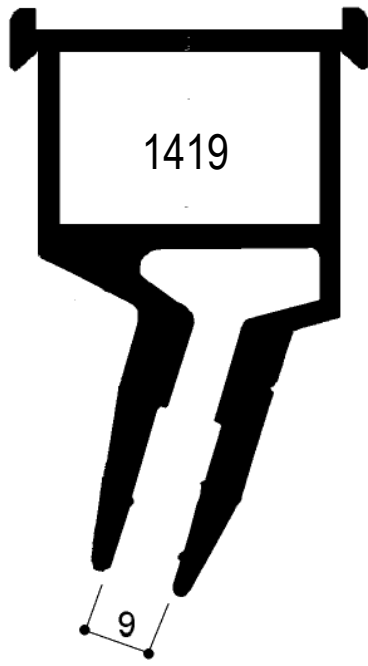

1419

9

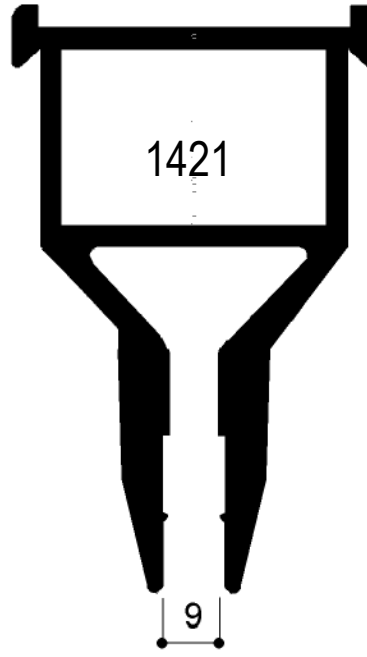

1421

9

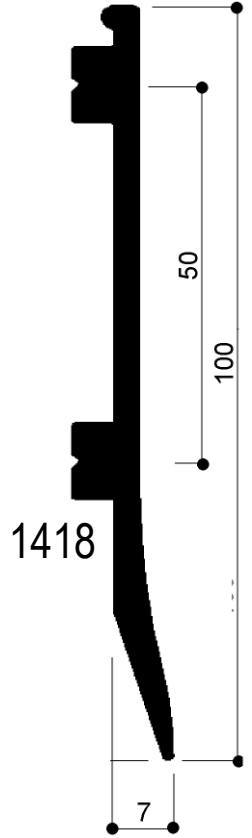

1418

7

50

100

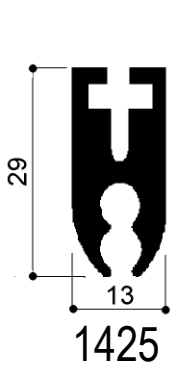

1425

29

13

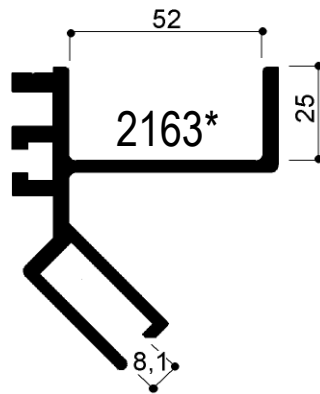

2163*

52

25

8,1

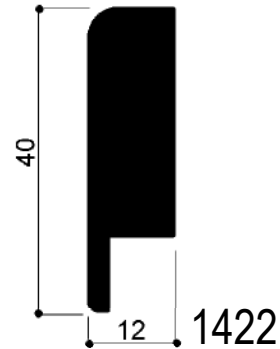

1422

40

12

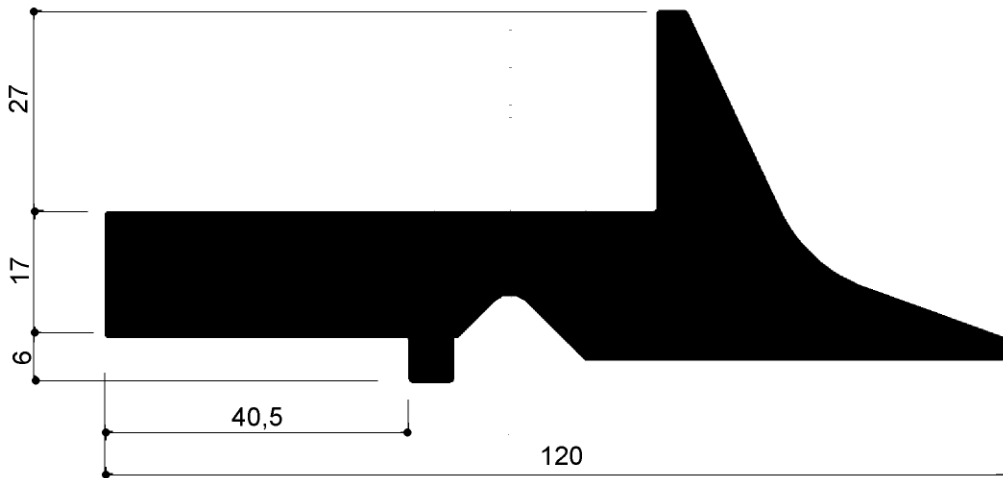

2120*

27

17

6

40,5

120





FOTO DE EJEMPLO: PERFILES DE ALUMINIO EXTRUIDO PARA SERIGRAFÍA PORTA RASQUILLO PARA:
 -MAQUINARIA: REGGIANI, MECCANOTESSILE, BUSER etc...
 -EN CARRO: GALY, VIERO, ROBUSTELLI etc...
 -PARA EL SECTOR DE LA SERIGRAFÍA: SIASPRINT, ARGON, THIEME etc..
 -CARRUSEL DE SERIGRAFIA: TEK-IND

RACLA

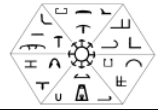

2113 LONGITUD DE BARRA 4 MT CON
 TORNILLOS DE CABEZA CILÍNDRICA M5 PURA COTIZACIÓN
 PASO DE TORNILLO INDICATIVO: APROX. 80MM
 (TOLERANCIA +/-5MM)

RACLA MECÁNICA

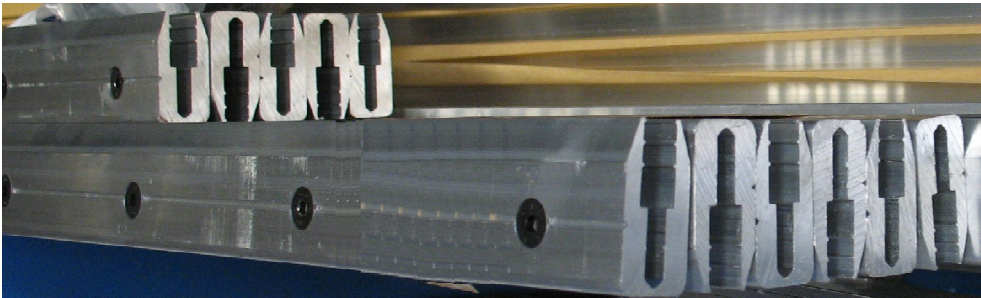

1413 / 1419 / 1421 / 1429 LONGITUD DE BARRA 4 MT CON
 TORNILLOS DE CABEZA AVELLANADA M6 CITA PURAMENTE INDICATIVA DE
 PASO DE TORNILLO: APROX. 100MM (TOLERANCIA +/-5MM)

RACLA A MANO

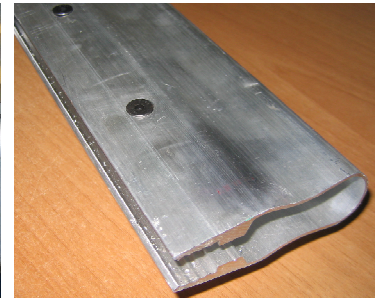

2031 LONGITUD DE LA BARRA
 MT 4 CON TORNILLOS DE CABEZA
 AVELLANADA M6 PURA COTIZACIÓN
 TONO INDICATIVO
 TORNILLOS: APROX. 100 MM
 (TOLERANCIA +/-5MM)

Perfiles Especiales - ETAPAS/ETAPAS



MEDIO DIBUJOS REALES (1:2) - ESCALA 1:2

Via Newton, n.12
20016 Pero (Milano - Italy)
Tel. +39 02 3535955 r.a. Fax. +39 02 3539929
E-Mail: info@omar-alluminio.it

Cataloghi Online: www.omar-alluminio.it
www.omar-alluminio.com

PERFILES DE ALUMINIO A MEDIDA / ESTÁNDAR / ESPECIAL / Y PARA:
ELECTRÓNICA / LED / FOTOVOLTAICA / AUTOMATIZACIÓN ROBOTICA / NEUMÁTICA / AUTOMOCIÓN

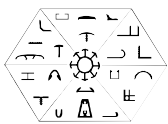
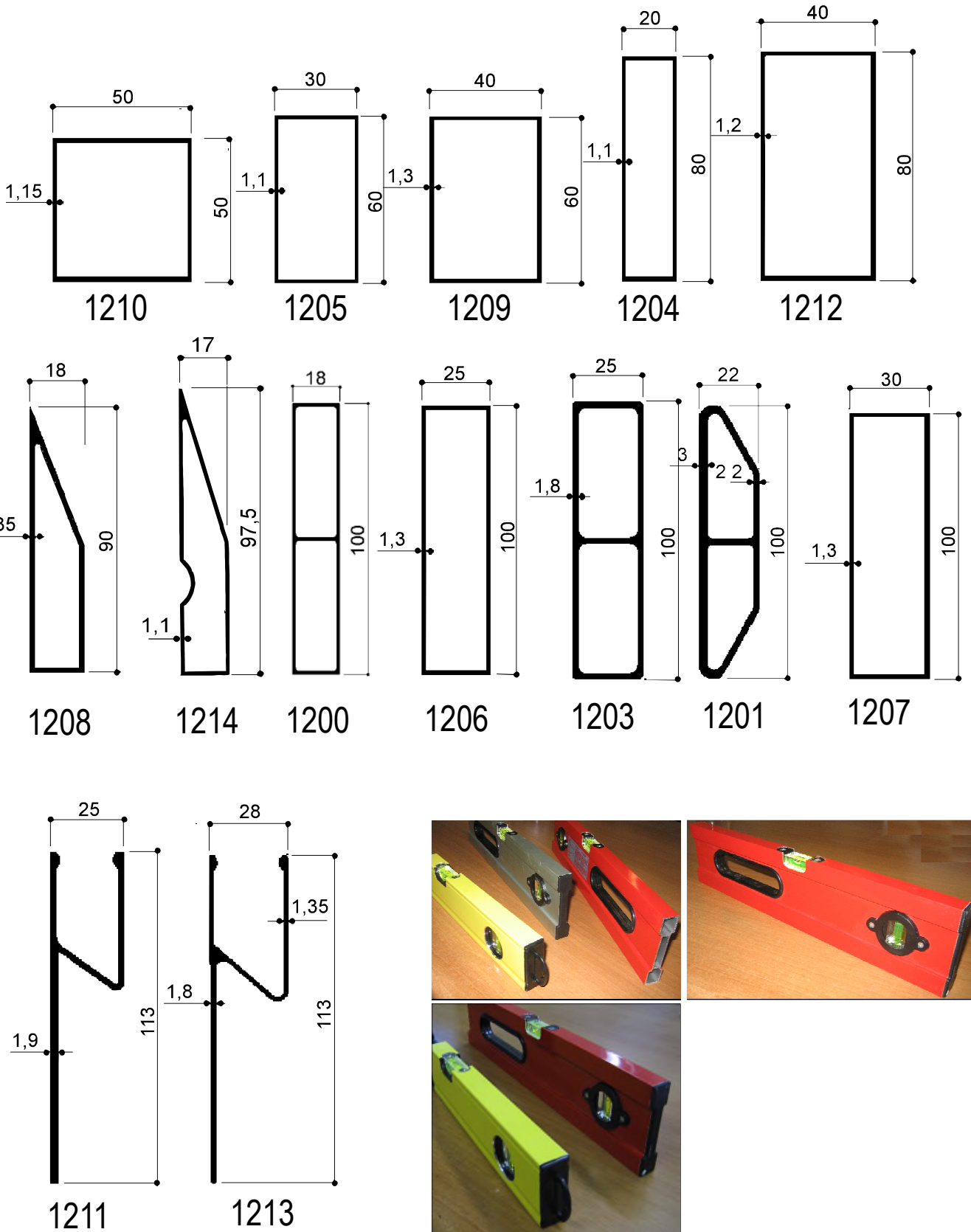

INCLUSO EN CANTIDADES MODESTAS SE PUEDEN SUMINISTRAR
DESPUÉS DE LA PREPARACIÓN DE LA MATRIZ, OTROS PERFILES
SEGÚN EL TUYO. PRESUPUESTO



Perfiles Especiales - Astilleros -



DIBUJOS DE VIDA (1:1) - ESCALA 1:1
PLÁSTICO EN ROLLOS DE 30 MT

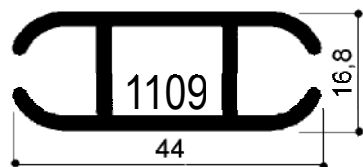
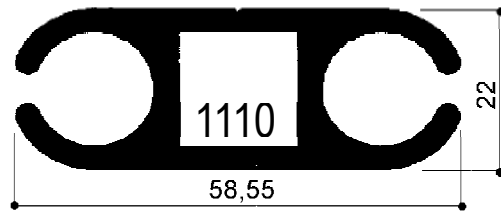
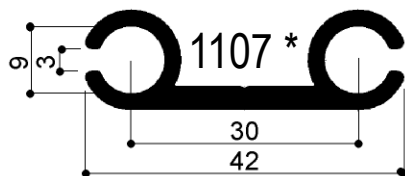
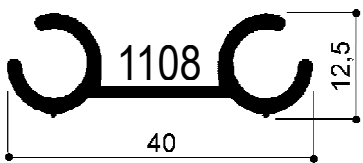
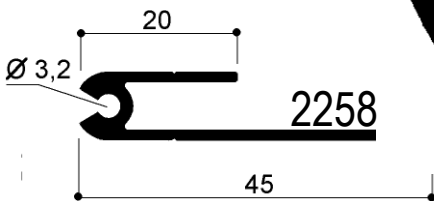
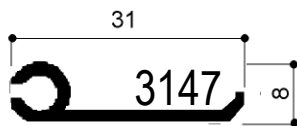
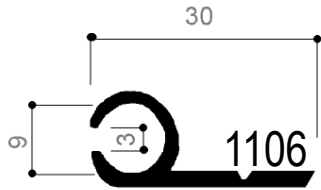
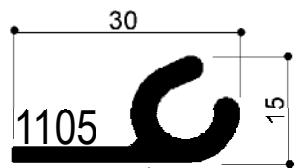
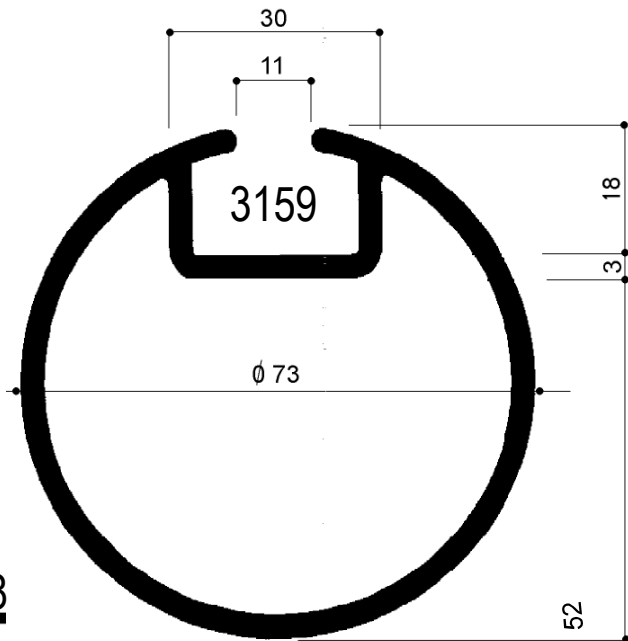
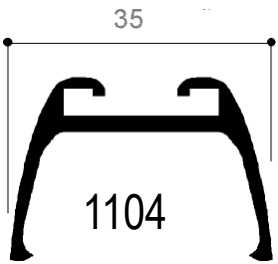
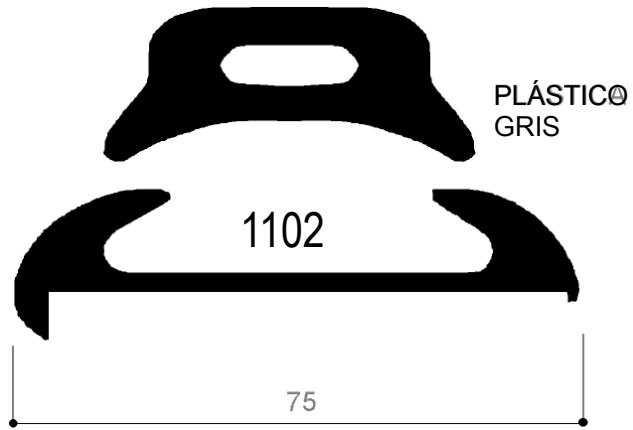
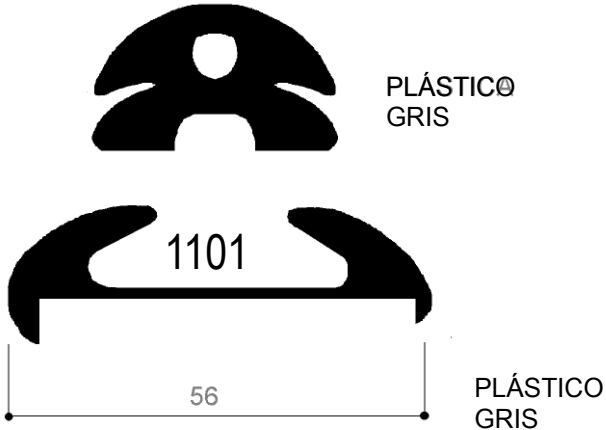
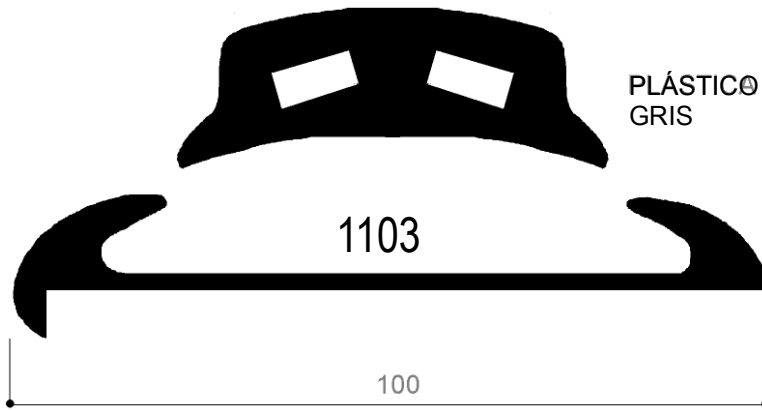
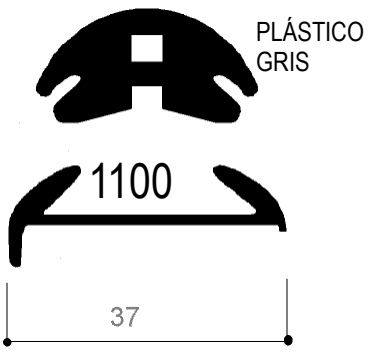

Via Newton, n.12
20016 Pero (Milano - Italy)
Tel. +39 02 3535955 r.a. Fax. +39 02 3539929
E-Mail: info@omar-alluminio.it

Catálogo Online: www.omar-alluminio.it
www.omar-alluminio.com

PERFILES DE ALUMINIO A MEDIDA / ESTÁNDAR / ESPECIAL / Y PARA:
ELECTRÓNICA / LED / FOTOVOLTAICA / AUTOMATIZACIÓN ROBOTICA / NEUMÁTICA / AUTOMOCIÓN



Perfiles Especiales - RODAPIÉS -



MEDIO DIBUJOS REALES (1:2) - ESCALA 1:2

Via Newton, n.12
20016 Pero (Milano - Italy)
Tel. +39 02 3535955 r.a. Fax. +39 02 3539929
E-Mail: info@omar-alluminio.it

Cataloghi Online: www.omar-alluminio.it
www.omar-alluminio.com
PERFILES DE ALUMINIO A MEDIDA / ESTÁNDAR / ESPECIAL / Y PARA:
ELECTRÓNICA / LED / FOTOVOLTAICA / AUTOMATIZACIÓN ROBOTICA / NEUMÁTICA / AUTOMOCIÓN



3091
EJEMPLO ASAMBLEA

3090 BUEY. SATÍN
QUÍMICO NATURAL

3092
BUEY. SATÍN
QUÍMICO NATURAL

3093
EJEMPLO ASAMBLEA

2012*
EJEMPLO ASAMBLEA

*PROFILO RISERVATO

3087 SATÍN
QUÍMICO NATURAL

3088
EJEMPLO ASAMBLEA

3085 BUEY. SATÍN QUÍMICO NATURAL

3086
EJEMPLO ASAMBLEA

3272 BUEY. SATÍN
QUÍMICO NATURAL

3271
EJEMPLO ASAMBLEA

3083 BUEY. SATÍN
QUÍMICO NATURAL

3084 BUEY. SATÍN
QUÍMICO NATURAL

3084

3234

3235

3236

3308
EJEMPLO ASAMBLEA

3309

ACABADO ESTÁNDAR LISTO
STOCK PARA TODOS LOS PERFILES
ILUSTRADO: OX SATINADO QUÍMICO
NATURAL

Perfiles Especiales - RODAPIÉS -

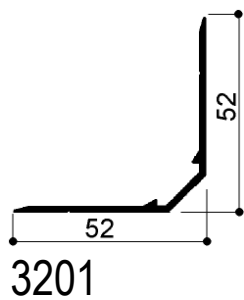

3201

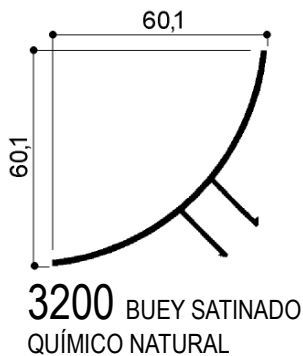

3200 BUEY SATINADO
QUÍMICO NATURAL

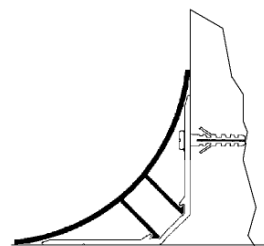

EJEMPLO
ASAMBLEA

ACCESSORI

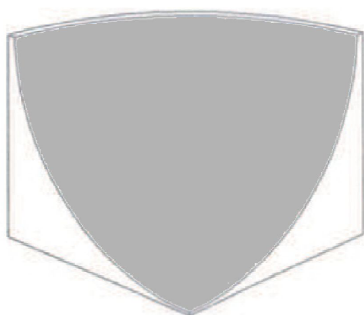

B-0001

ALUMINIO FUNDIDO 1/8 ESFERA
PINTADO NATURAL PARA
JUNTA DE ESQUINA DE PERFILES 3200 / 3201

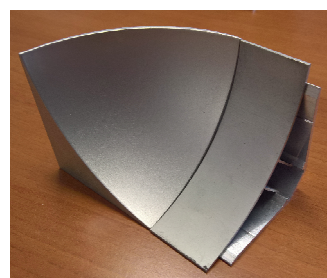

EJEMPLO ASAMBLEA

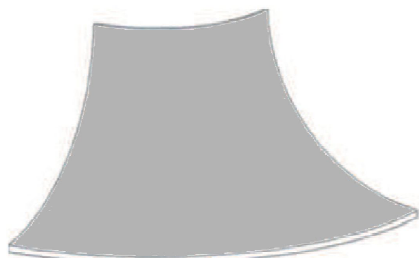

B-0002

ALUMINIO FUNDIDO 1/4 ESFERA
PINTADO NATURAL PARA JUNTAS
ESQUINA DE PERFILES 3200 / 3201

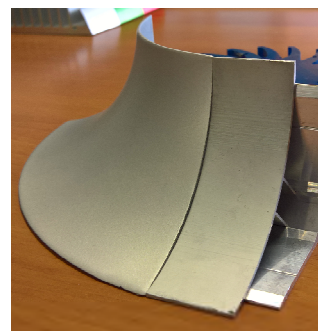

EJEMPLO ASAMBLEA

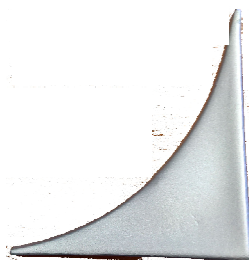

B-0003

TAPA DE EXTREMO DE ALUMINIO FUNDIDO
PINTADO NATURAL PARA PERFILES 3200 / 3201

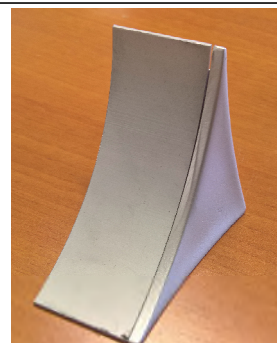

EJEMPLO ASAMBLEA

Via Newton, n.12

20016 Pero (Milano - Italy)

Tel. +39 02 3535955 r.a. Fax. +39 02 3539929

E-Mail: info@omar-alluminio.it

Catálogo Online: www.omar-alluminio.it

www.omar-alluminio.com

PERFILES DE ALUMINIO A MEDIDA / ESTÁNDAR / ESPECIAL / Y PARA:

ELECTRÓNICA / LED / FOTOVOLTAICA / AUTOMATIZACIÓN ROBÓTICA / NEUMÁTICA / AUTOMOCIÓN



Perfiles Especiales - RODAPIÉS -



Via Newton, n. 12
20016 Pero (Milano - Italy)
Tel. +39 02 3535955 r.a. Fax. +39 02 3539929
E. Mail: info@omar-alluminio.it

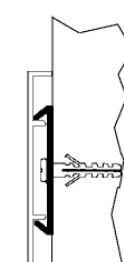
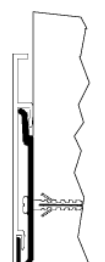
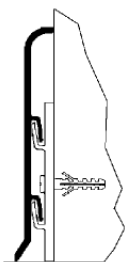

LISTA DE ACABADOS DISPONIBLES BAJO PEDIDO

ACABADO: ANODIZADO

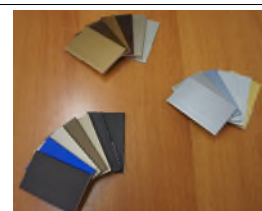

ELECTROCOLOR
BRONCE 15

ELECTROCOLOR
BRONCE 16

ELECTROCOLOR
BRONCE 17

ELECTROCOLOR
BRONCE 18

ELECTROCOLOR
BRONCE 19

ELECTROCOLOR
BRONCE 20

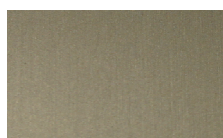

ELECTROCOLOR
COD.1



ELECTROCOLOR
COD. 2

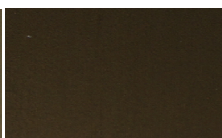

ELECTROCOLOR
COD. 3

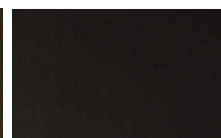

ELECTROCOLOR
COD. 4

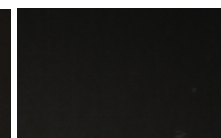

ELECTROCOLOR
COD. 5

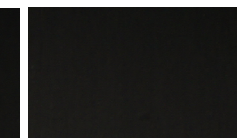

ELECTROCOLOR
COD. 6

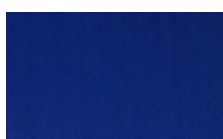

AZUL DE COBALTO



ORO

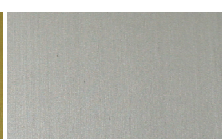

PLATA
CEPILLADO

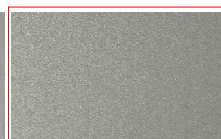

PLATA QUÍMICA
ACABADO ESTÁNDAR
DISPONIBLE
'DE LISTO'

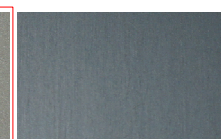

FUME'



ACERO



TITANIO PULIDO

ACABADO: PINTADO



COD.K06



COD.K09



COD.K17

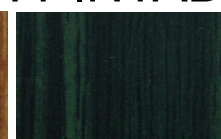

COD.K20

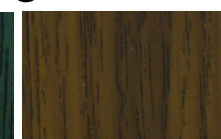

COD.K23

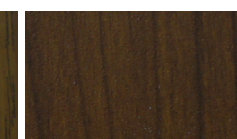

COD.K31



COD.K35

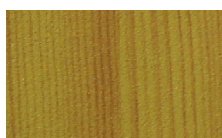

COD.K38



COD.K40

Cataloghi Online: www.omar-alluminio.it
www.omar-alluminio.com

PERFILES DE ALUMINIO A MEDIDA / ESTÁNDAR / ESPECIAL / Y PARA:
ELECTRÓNICA / LED / FOTOVOLTAICA / AUTOMATIZACIÓN ROBOTICA / NEUMÁTICA / AUTOMOCIÓN

OMAR s.r.l.
PROFILATI ALLUMINIO
ALTA TECNOLOGIA

Perfiles Especiales - MOBILIARIO URBANO

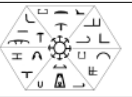

Via Newton, n.12
20016 Pero (Milano - Italy)
Tel. +39 02 3535955 r.a. Fax. +39 02 3539929
E.Mail: info@omar-alluminio.it

Cataloghi Online: www.omar-alluminio.it
www.omar-alluminio.com
PERFILES DE ALUMINIO A MEDIDA / ESTÁNDAR / ESPECIAL / Y PARA:
ELECTRÓNICA / LED / FOTOVOLTAICA / AUTOMATIZACIÓN ROBOTICA / NEUMÁTICA / AUTOMOCIÓN

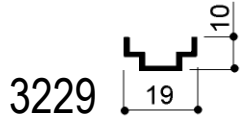
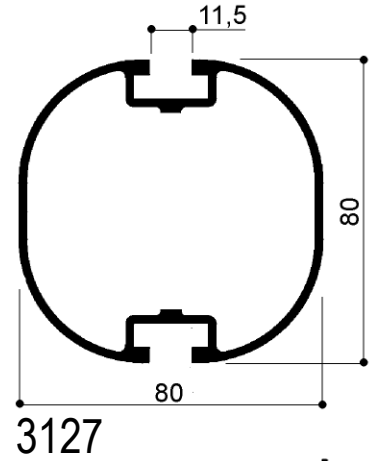
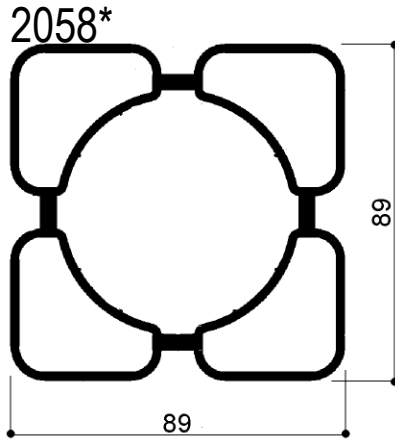
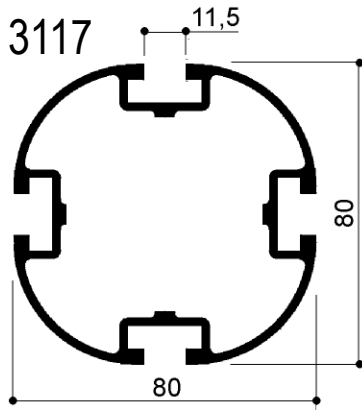

MEDIO DIBUJOS REALES (1:2) - ESCALA 1:2

-REPRODUCCIÓN PROHIBIDA-

Perfiles Especiales - Umbrales -

DIBUJOS DE VIDA (1:1) - ESCALA 1:1

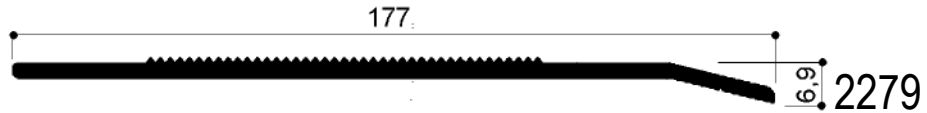

MEDIO DIBUJOS REALES (1:2) - ESCALA 1:2

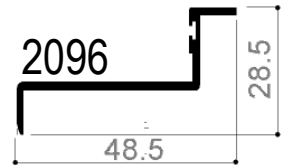
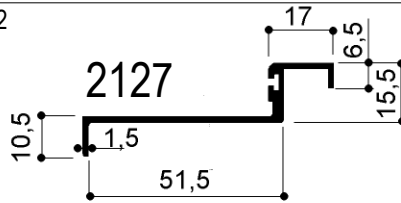
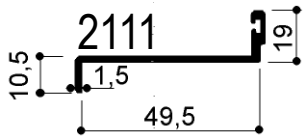

DIBUJOS DE VIDA (1:1) - ESCALA 1:1

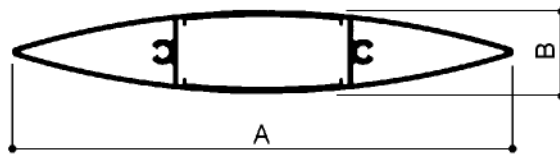
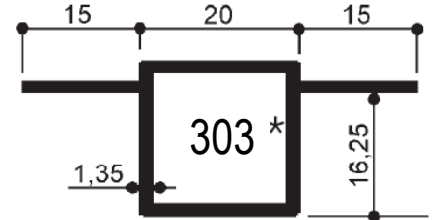
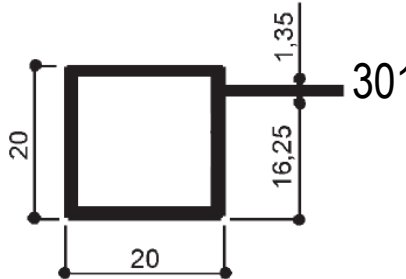
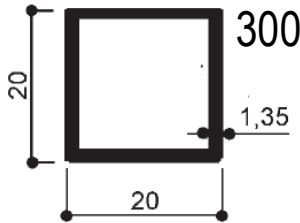

PERFILES PARA LÁMINAS SOLARES

Codice Articolo	Dimensione (Ax B)	Peso (kg/mt)
3362	150x25	1,68
3363	200x35	2,34
3360	270x50	3,64
3361	300x50	4,93
3364	300x50	4,72
3365	315x50	5,31
3367	350x50	4,82
3366	350x54	6,27
3368	350x60	6,07



Perfiles Especiales - MOBILIARIO URBANO

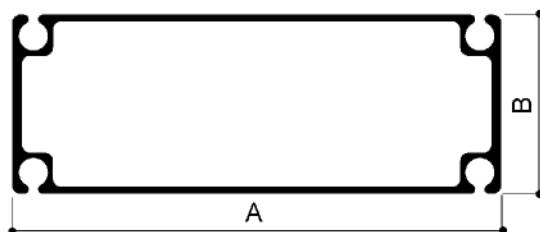

CODICE	AxB	PESO (Kg/Mt)
3373	70x46	1,541
3372	80x60	3,105
3390	94,11x48,08	2,567
3370	104x65	3,164
3371	124x75	3,802
3374	125x75	3,811
3375	130x70	4,145
3376	130x70,5	4,028
3388	140x75	5,413
3387	143x100	5,805
3389	143x100	4,897
3378	160x78	6,043
3377	162x100	5,319
3369	210x108	6,186
3379	210x110	8,801
3380	213x93	9,030
3381	213x111	6,812
3382	220x100	6,398
3383	240x110	8,068
3384	250x120	9,526
3385	300x110	11,038
3386	330x125	16,771

Perfiles Comerciales- Perfiles estándar de aluminio

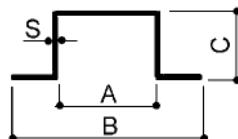

PERFILES OMEGA

B	C	A	S	PESO (Kg/m)	PERIMETRO (mm)
34,6	26,8	13,4	2,8	0,608	168
36	9,5	16	3	0,357	101
36	36	-	2	0,782	232
36	51	-	2	0,944	293
36	51	-	2	0,944	292
37,4	8	14	3	0,365	98
68	24,4	-	1,4	0,548	294
70	40	26	2	0,778	293
75	34	-	2,5	1,272	326
76,5	35	40,5	2,5	0,910	287
77	35	41	2	0,769	288
85	21	35	2	0,664	250
86	82	34	2,5	1,701	487
93,5	45,5	39	2,5	1,088	329
95	34,5	-	2	1,359	410
95	35	-	2	1,326	402
106	76	66	5	3,221	488
111	28,8	62	2,8	1,226	323
112	25	32	5	2,049	310
116,5	64	60,5	3	1,929	484
130	39	75,4	3	1,650	338
182	64	117	10	6,353	487
200	73	128,3	10	7,119	545

ALGUNOS PERFILES PUEDEN TENER ESPESOR VARIABLE Y ESQUINAS REDONDEADAS

ACCESORIOS para contenedores tarjeteros

Electrónica tipo DIN 43700

-DIBUJOS DE PERFIL ver página. 1 -

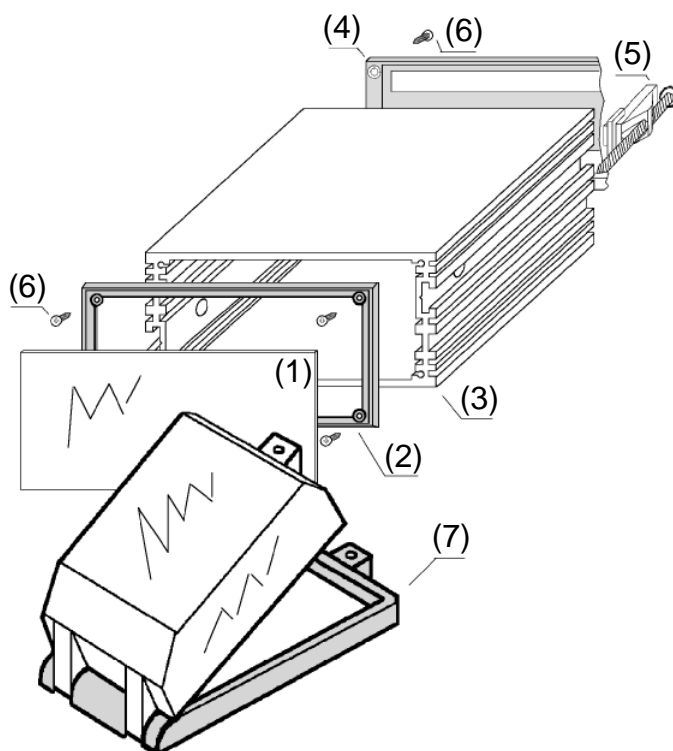

(1) PANEL FRONTAL EN ALUMINIO TODO CERRADO ESPESOR 15/10 OXIDADO PLATA CON 'PEELABLE' LISTO PARA CUALQUIER PERSONALIZACIÓN CON PERFORACIONES "PERSONALIZADAS" Y POSIBLE SERIGRAFÍA

(2) MARCO FRONTAL NEGRO EN NYLON - 30% FIBRA DE VIDRIO

(3) CUERPO DEL CONTENEDOR DE ALUMINIO CON PROFUNDIDAD LIBRE. DISPONIBLE CON DIFERENTES TRATAMIENTOS SUPERFICIALES (OXIDACIÓN: NEGRO, NATURAL, ROJO, AZUL, VERDE, ETC.). SON POSIBLES TRABAJOS MECÁNICOS (AGUJEROS, CORTES, FRESADOS)

(4) ALMOHADILLA TRASERA NEGRA EN NYLON 6 - 30% FIBRA DE VIDRIO DISPONIBLE EN DIFERENTES SOLUCIONES (ESPALDA ABIERTA, CERRADA, ½ ABIERTA, CON RANURA DE DESGARRO)

(5) GANCHOS DE FIJACIÓN EN MATERIAL PLÁSTICO NEGRO PARA MONTAJE EN PANEL

(6) TORNILLOS AUTOROSCANTES BRUÑIDOS PARA FIJACIÓN DE MARCOS O PANELES DE ALUMINIO

(7) PROTECCIÓN ANTI-SPLASH EN POLICARBONATO TRANSPARENTE

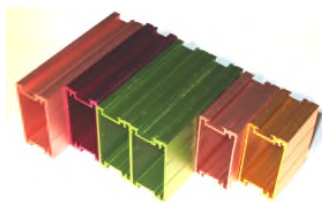

COD.	TIPO ARTICULO	PAG	COD.	TIPO ARTICULO	PAG	COD.	TIPO ARTICULO	PAG
100	DISSIPATORE	62	316	PROFILI FOTOVOLTAICO	103	400	DISSIPATORE	4
101	DISSIPATORE	62	317	PROFILI FOTOVOLTAICO	103	401	DISSIPATORE	4
103	DISSIPATORE	62	318	PROFILI FOTOVOLTAICO	97	402	DISSIPATORE	4
104	DISSIPATORE	62	320	PROFILI FOTOVOLTAICO	98	403	DISSIPATORE	4
105	DISSIPATORE	62	321	PROFILI FOTOVOLTAICO	96	404	DISSIPATORE	4
106	DISSIPATORE	62	322	PROFILI FOTOVOLTAICO	96	405	DISSIPATORE	4
108	DISSIPATORE	62	323	PROFILI FOTOVOLTAICO	96	406	DISSIPATORE	4
109	DISSIPATORE	62	324	PROFILI FOTOVOLTAICO	96	408	DISSIPATORE	5
110	DISSIPATORE	62	325	PROFILI FOTOVOLTAICO	96	409	DISSIPATORE	5
111	DISSIPATORE	62	326	PROFILI FOTOVOLTAICO	97	410	DISSIPATORE	5
112	DISSIPATORE	62	328	PROFILI COM PONIBILI	65	411	DISSIPATORE	5
113	DISSIPATORE	62	329	PROFILI FOTOVOLTAICO	97	412	DISSIPATORE	5
117	DISSIPATORE	62	330	PROFILI COM PONIBILI	67	413	DISSIPATORE	4
121	DISSIPATORE	62	331	PROFILI FOTOVOLTAICO	99	414	DISSIPATORE	53
122	DISSIPATORE	62	332	PROFILI FOTOVOLTAICO	93	415	DISSIPATORE	5
123	DISSIPATORE	62	333	PROFILI FOTOVOLTAICO	70-93	416	DISSIPATORE	5
124	DISSIPATORE	62	335	PROFILI FOTOVOLTAICO	70-93	419	DISSIPATORE	4
130	DISSIPATORE	62	336	PROFILI FOTOVOLTAICO	101	420	DISSIPATORE	53
134	DISSIPATORE	62	337	PROFILI FOTOVOLTAICO	91	421	DISSIPATORE	5
135	DISSIPATORE	62	338	PROFILI FOTOVOLTAICO	92	423	DISSIPATORE	4
144	DISSIPATORE	62	339	PROFILI FOTOVOLTAICO	92	424	DISSIPATORE	53
146	DISSIPATORE	62	340	PROFILI FOTOVOLTAICO	92	427	DISSIPATORE	50
147	DISSIPATORE	62	345	PROFILI COM PONIBILI	69	428	DISSIPATORE	57
149	DISSIPATORE	62	346	PROFILI FOTOVOLTAICO	103	429	DISSIPATORE	11
160	DISSIPATORE	61	347	PROFILI FOTOVOLTAICO	103	430	DISSIPATORE	12
161	DISSIPATORE	61	348	PROFILI FOTOVOLTAICO	103	432	DISSIPATORE	11
162	DISSIPATORE	61	349	PROFILI FOTOVOLTAICO	96	433	DISSIPATORE	14
163	DISSIPATORE	61	350	PROFILI COM PONIBILI	65	434	DISSIPATORE	21
164	DISSIPATORE	61	351	PROFILI FOTOVOLTAICO	97	438	DISSIPATORE	9
165	DISSIPATORE	61	352	PROFILI FOTOVOLTAICO	97	439	DISSIPATORE	10
166	DISSIPATORE	61	355	PROFILI FOTOVOLTAICO	98	440	DISSIPATORE	11
167	DISSIPATORE	61	356	PROFILI FOTOVOLTAICO	98	441	DISSIPATORE	7
168	DISSIPATORE	61	357	PROFILI COM PONIBILI	66	442	DISSIPATORE	5
169	DISSIPATORE	61	358	PROFILI COM PONIBILI	66	443	DISSIPATORE	10
170	DISSIPATORE	61	359	PROFILI FOTOVOLTAICO	70-93	444	DISSIPATORE	9
171	DISSIPATORE	61	360	PROFILI COM PONIBILI	69	445	DISSIPATORE	19
180	DISSIPATORE	61	361	PROFILI COM PONIBILI	69	446	DISSIPATORE	5
188	DISSIPATORE	61	362	PROFILI COM PONIBILI	69	447	DISSIPATORE	4
189	DISSIPATORE	61	363	PROFILI COM PONIBILI	69	449	DISSIPATORE	5
190	DISSIPATORE	61	364	PROFILI COM PONIBILI	69	450	DISSIPATORE	28
195	DISSIPATORE	61	365	PROFILI COM PONIBILI	69	451	DISSIPATORE	29
238	DISSIPATORE	63	366	PROFILI COM PONIBILI	69	452	DISSIPATORE	30
239	DISSIPATORE	63	367	PROFILI COM PONIBILI	69-94	453	DISSIPATORE	28
240	DISSIPATORE	63	368	PROFILI FOTOVOLTAICO	99	454	DISSIPATORE	30
241	DISSIPATORE	63	369	PROFILI FOTOVOLTAICO	99	455	DISSIPATORE	33
243	DISSIPATORE	63	370	PROFILI FOTOVOLTAICO	99	456	DISSIPATORE	40
244	DISSIPATORE	63	371	PROFILI COM PONIBILI	74	457	DISSIPATORE	43
246	DISSIPATORE	63	372	PROFILI COM PONIBILI	75	458	DISSIPATORE	28
247	DISSIPATORE	63	373	PROFILI COM PONIBILI	76	459	DISSIPATORE	29
248	DISSIPATORE	63	374	PROFILI COM PONIBILI	77	460	DISSIPATORE	34
249	DISSIPATORE	63	375	PROFILI COM PONIBILI	78	461	DISSIPATORE	46
250	DISSIPATORE	63	376	PROFILI COM PONIBILI	74	462	DISSIPATORE	31
251	DISSIPATORE	61	377	PROFILI COM PONIBILI	75	463	DISSIPATORE	30
252	DISSIPATORE	61	378	PROFILI FOTOVOLTAICO	97	464	DISSIPATORE	31
254	DISSIPATORE	61	379	PROFILI FOTOVOLTAICO	98	465	DISSIPATORE	34
271	DISSIPATORE	63	380	PROFILI FOTOVOLTAICO	92	466	DISSIPATORE	41
272	DISSIPATORE	63	381	PROFILI FOTOVOLTAICO	92	467	DISSIPATORE	44
300	PROFILI SPECIALI	130	382	PROFILI FOTOVOLTAICO	98	468	DISSIPATORE	49
301	PROFILI SPECIALI	130	383	PROFILI FOTOVOLTAICO	97	469	DISSIPATORE	50
303	PROFILI SPECIALI	130	384	PROFILI FOTOVOLTAICO	97	470	DISSIPATORE	44
304	PROFILI COM PONIBILI	66	385	PROFILI FOTOVOLTAICO	99	471	DISSIPATORE	42
305	PROFILI COM PONIBILI	70	386	PROFILI FOTOVOLTAICO	92	472	DISSIPATORE	45
306	PROFILI COM PONIBILI	65	387	PROFILI FOTOVOLTAICO	92	473	DISSIPATORE	46
307	PROFILI COM PONIBILI	65	388	PROFILI FOTOVOLTAICO	101	474	DISSIPATORE	45
309	PROFILI FOTOVOLTAICO	103	389	PROFILI FOTOVOLTAICO	103	475	DISSIPATORE	33
310	PROFILI SPECIALI	74	390	PROFILI FOTOVOLTAICO	98	476	DISSIPATORE	32
311	PROFILI SPECIALI	74	391	PROFILI FOTOVOLTAICO	95	477	DISSIPATORE	29
313	PROFILI FOTOVOLTAICO	94	392	PROFILI FOTOVOLTAICO	95	478	DISSIPATORE	47
314	PROFILI FOTOVOLTAICO	103	398	PROFILI COM PONIBILI	70	479	DISSIPATORE	40
315	PROFILI FOTOVOLTAICO	103	399	PROFILI COM PONIBILI	70	480	DISSIPATORE	35

Via Newton, n. 12
20016 Pero (Milano - Italy)
Tel. +39 02 3535955 r.a. Fax. +39 02 3539929
E-Mail: info@omar-alluminio.it

Cataloghi Online: www.omar-alluminio.it
www.omar-alluminio.com
PERFILES DE ALUMINIO A MEDIDA / ESTÁNDAR / ESPECIAL / Y PARA:
ELECTRÓNICA / LED / FOTOVOLTAICA / AUTOMATIZACIÓN ROBOTICA / NEUMÁTICA / AUTOMOCIÓN

Índice de artículos

Consulta el Catálogo Online actualizado
en www.omar-alluminio.it

481	DISSIPATORE	38	705	PROFILI FOTOVOLTAICO	101	780	PROFILI COM PONIBILI	68-94
482	DISSIPATORE	39	706	PROFILI FOTOVOLTAICO	103	781	PROFILI FOTOVOLTAICO	103
483	DISSIPATORE	37	707	PROFILI FOTOVOLTAICO	103	782	PROFILI FOTOVOLTAICO	103
484	DISSIPATORE	36	708	PROFILI COM PONIBILI	68	783	PROFILI FOTOVOLTAICO	103
485	DISSIPATORE	42	709	PROFILI COM PONIBILI	68	784	PROFILI COM PONIBILI	65
486	DISSIPATORE	32	710	PROFILI COM PONIBILI	68	785	PROFILI COM PONIBILI	65
487	DISSIPATORE	36	711	PROFILI COM PONIBILI	68	786	PROFILI COM PONIBILI	68
489	DISSIPATORE	37	713	PROFILI FOTOVOLTAICO	101	787	PROFILI FOTOVOLTAICO	70-93
490	DISSIPATORE	48	715	PROFILI COM PONIBILI	73	788	PROFILI FOTOVOLTAICO	94
491	DISSIPATORE	41	716	PROFILI COM PONIBILI	73	789	PROFILI COM PONIBILI	65
492	DISSIPATORE	38	717	PROFILI COM PONIBILI	73	792	PROFILI FOTOVOLTAICO	98
493	DISSIPATORE	39	718	PROFILI COM PONIBILI	73	793	PROFILI FOTOVOLTAICO	101
494	DISSIPATORE	43	719	PROFILI COM PONIBILI	73	794	PROFILI FOTOVOLTAICO	103
495	DISSIPATORE	47	720	PROFILI COM PONIBILI	73	794/1	PROFILI FOTOVOLTAICO	103
496	DISSIPATORE	48	721	PROFILI COM PONIBILI	73	796	PROFILI COM PONIBILI	70-93
497	DISSIPATORE	49	722	PROFILI COM PONIBILI	73	797	PROFILI FOTOVOLTAICO	70-93
500	DISSIPATORE	6	723	PROFILI COM PONIBILI	73	798	PROFILI COM PONIBILI	69
503	DISSIPATORE	7	724	PROFILI COM PONIBILI	73	799	PROFILI FOTOVOLTAICO	97
505	DISSIPATORE	8	725	PROFILI COM PONIBILI	73	801	DISSIPATORE	4
513	DISSIPATORE	10	726	PROFILI COM PONIBILI	67	802	DISSIPATORE	4
525	DISSIPATORE	13	727	PROFILI COM PONIBILI	67	803	DISSIPATORE	12
526	DISSIPATORE	6 -57	729	PROFILI COM PONIBILI	67	804	DISSIPATORE	15
527	DISSIPATORE	57	730	PROFILI COM PONIBILI	66	805	DISSIPATORE	12
528	DISSIPATORE	57	731	PROFILI COM PONIBILI	66	806	DISSIPATORE	4
529	DISSIPATORE	9	732	PROFILI COM PONIBILI	66	807	DISSIPATORE	4
530	DISSIPATORE	12	733	PROFILI COM PONIBILI	66	808	DISSIPATORE	5
531	DISSIPATORE	7	734	PROFILI COM PONIBILI	66	809	DISSIPATORE	6
532	DISSIPATORE	10	735	PROFILI COM PONIBILI	65	810	DISSIPATORE	6
533	DISSIPATORE	57	736	PROFILI COM PONIBILI	65	811	DISSIPATORE	5
534	DISSIPATORE	57	737	PROFILI COM PONIBILI	65	812	DISSIPATORE	6
537	DISSIPATORE	7	738	PROFILI FOTOVOLTAICO	91	813	DISSIPATORE	8
545	DISSIPATORE	7	739	PROFILI COM PONIBILI	66	814	DISSIPATORE	12
600	DISSIPATORE	52	740	PROFILI COM PONIBILI	66	815	DISSIPATORE	7
601	DISSIPATORE	52	741	PROFILI COM PONIBILI	67	816	DISSIPATORE	8
602	DISSIPATORE	52	742	PROFILI COM PONIBILI	67	817	DISSIPATORE	8
603	DISSIPATORE	51	743	PROFILI COM PONIBILI	67	818	DISSIPATORE	9
604	DISSIPATORE	52	745	PROFILI COM PONIBILI	66	819	DISSIPATORE	9
605	DISSIPATORE	52	746	PROFILI COM PONIBILI	65	820	DISSIPATORE	9
608	DISSIPATORE	51	747	PROFILI COM PONIBILI	66	821	DISSIPATORE	24
610	DISSIPATORE	51	748	PROFILI COM PONIBILI	68	822	DISSIPATORE	15
611	DISSIPATORE	51	749	PROFILI COM PONIBILI	68	823	DISSIPATORE	10
613	DISSIPATORE	51	750	PROFILI COM PONIBILI	66	824	DISSIPATORE	15
617	DISSIPATORE	7	751	PROFILI COM PONIBILI	68	825	DISSIPATORE	10
618	DISSIPATORE	7	752	PROFILI COM PONIBILI	68-93	826	DISSIPATORE	14
619	DISSIPATORE	51	753	PROFILI COM PONIBILI	67	827	DISSIPATORE	11
620	DISSIPATORE	50	754	PROFILI COM PONIBILI	66	828	DISSIPATORE	11
621	DISSIPATORE	51	755	PROFILI COM PONIBILI	65	829	DISSIPATORE	12
622	DISSIPATORE	20	756	PROFILI COM PONIBILI	65	830	DISSIPATORE	12
624	DISSIPATORE	15	757	PROFILI COM PONIBILI	65	831	DISSIPATORE	8
626	DISSIPATORE	51	758	PROFILI FOTOVOLTAICO	101	832	DISSIPATORE	8
629	DISSIPATORE	10	759	PROFILI COM PONIBILI	66	833	DISSIPATORE	6
633	DISSIPATORE	50	760	PROFILI COM PONIBILI	65	834	DISSIPATORE	6
634	DISSIPATORE	17	761	PROFILI COM PONIBILI	72	835	DISSIPATORE	16
637	DISSIPATORE	52	762	PROFILI COM PONIBILI	72	836	DISSIPATORE	22
638	DISSIPATORE	52	763	PROFILI COM PONIBILI	72	837	DISSIPATORE	6
639	DISSIPATORE	52	764	PROFILI COM PONIBILI	72	838	DISSIPATORE	13
640	DISSIPATORE	53	765	PROFILI COM PONIBILI	72	839	DISSIPATORE	6
641	DISSIPATORE	53	766	PROFILI COM PONIBILI	72	841	DISSIPATORE	4
642	DISSIPATORE	52	767	PROFILI COM PONIBILI	69	842	DISSIPATORE	9
645	DISSIPATORE	54	768	PROFILI COM PONIBILI	72	843	DISSIPATORE	8
646	DISSIPATORE	55	769	PROFILI COM PONIBILI	65	844	DISSIPATORE	12
647	DISSIPATORE	9	770	PROFILI COM PONIBILI	65	845	DISSIPATORE	9
648	DISSIPATORE	51	771	PROFILI COM PONIBILI	65	846	DISSIPATORE	14
649	DISSIPATORE	6	772	PROFILI FOTOVOLTAICO	72	847	DISSIPATORE	9
650	DISSIPATORE	6	773	PROFILI FOTOVOLTAICO	72	848	DISSIPATORE	12
651	DISSIPATORE	4	774	PROFILI COM PONIBILI	72	849	DISSIPATORE	10
652	DISSIPATORE	21	775	PROFILI COM PONIBILI	68	850	DISSIPATORE	13
653	DISSIPATORE	10	776	PROFILI COM PONIBILI	66	851	DISSIPATORE	10
654	DISSIPATORE	53	777	PROFILI COM PONIBILI	66	852	DISSIPATORE	15
700	PROFILI FOTOVOLTAICO	92	778	PROFILI COM PONIBILI	68	853	DISSIPATORE	16
703	PROFILI FOTOVOLTAICO	94	779	PROFILI COM PONIBILI	68-94	855	DISSIPATORE	20



Índice de artículos

Consulta el Catálogo Online actualizado en www.omar-alluminio.it

856	DISSIPATORE	8	938	DISSIPATORE	8	1203	PROFILI SPECIALI	124
857	DISSIPATORE	8	939	DISSIPATORE	8	1204	PROFILI SPECIALI	124
858	DISSIPATORE	9	940	DISSIPATORE	14	1205	PROFILI SPECIALI	124
863	DISSIPATORE	8	944	DISSIPATORE	8	1206	PROFILI SPECIALI	124
865	DISSIPATORE	22	945	DISSIPATORE	7	1207	PROFILI SPECIALI	124
867	DISSIPATORE	9	946	DISSIPATORE	22	1208	PROFILI SPECIALI	124
869	DISSIPATORE	9	947	DISSIPATORE	18	1209	PROFILI SPECIALI	124
871	DISSIPATORE	24	948	DISSIPATORE	18	1210	PROFILI SPECIALI	124
872	DISSIPATORE	18	950	DISSIPATORE	19	1211	PROFILI SPECIALI	124
873	DISSIPATORE	20	951	DISSIPATORE	8	1212	PROFILI SPECIALI	124
874	DISSIPATORE	21	952	DISSIPATORE	21	1213	PROFILI SPECIALI	124
875	DISSIPATORE	20	953	PROFILI SPECIALI	109	1214	PROFILI SPECIALI	124
876	DISSIPATORE	23	956	DISSIPATORE	16-55	1300	PROFILI SPECIALI	106
879	DISSIPATORE	17	958	DISSIPATORE	20	1302	PROFILI SPECIALI	106
880	DISSIPATORE	17	959	DISSIPATORE	12	1303	PROFILI SPECIALI	106
881	DISSIPATORE	16	960	DISSIPATORE	18	1306	PROFILI SPECIALI	106
882	DISSIPATORE	7	961	DISSIPATORE	28	1308	PROFILI SPECIALI	106
883	DISSIPATORE	6	962	DISSIPATORE	23	1309	PROFILI SPECIALI	106
884	DISSIPATORE	6	963	DISSIPATORE	7	1312	PROFILI SPECIALI	106
885	DISSIPATORE	13	965	DISSIPATORE	4	1313	PROFILI SPECIALI	106
886	DISSIPATORE	10	967	DISSIPATORE	13	1315	PROFILI SPECIALI	106
887	DISSIPATORE	13	968	DISSIPATORE	13	1321	PROFILI SPECIALI	106
888	DISSIPATORE	6	969	DISSIPATORE	53	1322	PROFILI SPECIALI	106
889	DISSIPATORE	11	970	DISSIPATORE	10	1323	PROFILI SPECIALI	106
890	DISSIPATORE	9	971	DISSIPATORE	11	1324	PROFILI SPECIALI	106
891	DISSIPATORE	14	972	DISSIPATORE	4	1325	PROFILI SPECIALI	106
892	DISSIPATORE	8	973	DISSIPATORE	19	1326	PROFILI SPECIALI	106
893	DISSIPATORE	6	974	DISSIPATORE	16	1328	PROFILI SPECIALI	106
894	DISSIPATORE	19	975	DISSIPATORE	4	1329	PROFILI SPECIALI	106
895	DISSIPATORE	11	976	DISSIPATORE	19	1330	PROFILI SPECIALI	106
896	DISSIPATORE	15	977	DISSIPATORE	60	1333	PROFILI SPECIALI	106
897	DISSIPATORE	20	978	DISSIPATORE	10	1338	PROFILI SPECIALI	106
898	DISSIPATORE	14	979	DISSIPATORE	23-25	1400	PROFILI RACLE	121
899	DISSIPATORE	21	980	DISSIPATORE	25	1403	PROFILI RACLE	121
900	DISSIPATORE	11	981	DISSIPATORE	25	1404	PROFILI RACLE	121
901	DISSIPATORE	15	982	DISSIPATORE	26	1405	PROFILI RACLE	121
902	DISSIPATORE	21	983/N	DISSIPATORE	11	1407	PROFILI RACLE	121
903	DISSIPATORE	11	984	DISSIPATORE	17-25	1409	PROFILI RACLE	121
904	DISSIPATORE	12	985	DISSIPATORE	12	1412	PROFILI RACLE	121
905	DISSIPATORE	12	986	DISSIPATORE	26	1413	PROFILI RACLE	121
906	DISSIPATORE	8	987	DISSIPATORE	26	1416	PROFILI RACLE	121
907	DISSIPATORE	9	988	DISSIPATORE	27	1417	PROFILI RACLE	121
908	DISSIPATORE	59	989	DISSIPATORE	27	1418	PROFILI RACLE	122
909	DISSIPATORE	6	990	DISSIPATORE	27	1419	PROFILI RACLE	122
910	DISSIPATORE	24	991	DISSIPATORE	27	1420	PROFILI RACLE	121
911	DISSIPATORE	16	992	DISSIPATORE	25	1421	PROFILI RACLE	122
912	DISSIPATORE	14	993	DISSIPATORE	26	1422	PROFILI RACLE	122
913	DISSIPATORE	52	994	DISSIPATORE	22	1424	PROFILI SPECIALI	121
914	DISSIPATORE	7	996	DISSIPATORE	21	1425	PROFILI SPECIALI	122
915	DISSIPATORE	6	997	DISSIPATORE	9	1429	PROFILI RACLE	121
916	DISSIPATORE	8	998	DISSIPATORE	15	1621	PROFILI SPECIALI	107
917	DISSIPATORE	60	999	DISSIPATORE	12	1824	PROFILI SPECIALI	107
918	DISSIPATORE	24	1000	PROFILI STAND	64	2003	PROFILI SPECIALI	118
919	DISSIPATORE	6	1001	PROFILI STAND	64	2005	CONTENITORE ELETTRONICA	3
920	DISSIPATORE	19-54	1002	PROFILI STAND	64	2012	PROFILI SPECIALI	126
921	DISSIPATORE	9	1005	PROFILI STAND	64	2015	PROFILI RACLE	121
922	DISSIPATORE	60	1008	PROFILI STAND	64	2017	DISSIPATORE	55
923	DISSIPATORE	60	1013	PROFILI STAND	64	2019	PROFILI SPECIALI	120
924	DISSIPATORE	16	1100	PROFILI SPECIALI	125	2021	PROFILI SPECIALI	109
925	DISSIPATORE	18	1101	PROFILI SPECIALI	125	2022	PROFILI SPECIALI	109
926	DISSIPATORE	22	1102	PROFILI SPECIALI	125	2024	PROFILI SPECIALI	109
927	DISSIPATORE	22	1103	PROFILI SPECIALI	125	2031	PROFILI RACLE	121
928	DISSIPATORE	16	1104	PROFILI SPECIALI	125	2036	DISSIPATORE	5-72
929	DISSIPATORE	18	1105	PROFILI SPECIALI	125	2040	PROFILI SPECIALI	111
930	DISSIPATORE	23	1106	PROFILI SPECIALI	125	2041	PROFILI COMPONIBILI	72
931	DISSIPATORE	10	1107	PROFILI SPECIALI	125	2042	PROFILI COMPONIBILI	72
932	DISSIPATORE	17	1108	PROFILI SPECIALI	125	2043	PROFILI COMPONIBILI	72
933	DISSIPATORE	20	1109	PROFILI SPECIALI	125	2047	DISSIPATORE	3
934	DISSIPATORE	6	1110	PROFILI SPECIALI	125	2048	DISSIPATORE	3-106
936	DISSIPATORE	12	1200	PROFILI SPECIALI	124	2049	DISSIPATORE	59
937	DISSIPATORE	16	1201	PROFILI SPECIALI	124	2052	CONTENITORE ELETTRONICA	3



Catálogo Online: www.omar-alluminio.it
www.omar-alluminio.com

PERFILES DE ALUMINIO A MEDIDA / ESTÁNDAR / ESPECIAL / Y PARA:
 ELECTRÓNICA / LED / FOTOVOLTAICA / AUTOMATIZACIÓN ROBÓTICA / NEUMÁTICA / AUTOMOCIÓN

Via Newton, n.12

20016 Pero (Milano - Italy)

Tel. +39 02 3535955 r.a. Fax. +39 02 3539929

E-Mail: info@omar-alluminio.it

Índice de artículos

Consulta el Catálogo Online actualizado
 en www.omar-alluminio.it

2058	PROFILI SPECIALI	130	2271	DISSIPATORE	55	3022	PROFILI SPECIALI	120
2065	CONTENITORE ELETTRONICA	2	2273	DISSIPATORE	5	3024	PROFILI SPECIALI	120
2066	PROFILI SPECIALI	108	2274	DISSIPATORE	54	3026/N	PROFILI SPECIALI	115
2069	PROFILI FOTOVOLTAICO	94	2276	PROFILI FOTOVOLTAICO	99	3027/N	PROFILI SPECIALI	115
2072	DISSIPATORE	7	2277	PROFILI SPECIALI	116	3028	PROFILI SPECIALI	115
2072D46	DISSIPATORE	7	2278	DISSIPATORE	6	3029	PROFILI SPECIALI	108
2073	DISSIPATORE	9	2279	PROFILI SPECIALI	130	3030	PROFILI SPECIALI	108
2073D70	DISSIPATORE	8	2298	DISSIPATORE	5	3031	PROFILI SPECIALI	108
2074D46	DISSIPATORE	7	2300	PROFILI PNEUMATICA	90	3032	PROFILI SPECIALI	108
2075	DISSIPATORE	7	2318	PROFILI SPECIALI	118	3033	PROFILI SPECIALI	108
2076	DISSIPATORE	11	2320	PROFILI SPECIALI	120	3034	PROFILI SPECIALI	108
2077	PROFILI SPECIALI	114	2321	PROFILI SPECIALI	118	3035	PROFILI SPECIALI	120
2091	CONTENITORE ELETTRONICA	1	2322	PROFILI SPECIALI	118	3036	PROFILI SPECIALI	114
2096	PROFILI SPECIALI	130	2323	PROFILI SPECIALI	118	3037	PROFILI SPECIALI	114
2097	DISSIPATORE	59	2324	PROFILI SPECIALI	118	3043	PROFILI SPECIALI	119
2098	DISSIPATORE	56	2325	PROFILI SPECIALI	119	3044	PROFILI SPECIALI	118
2100	DISSIPATORE	5	2326	PROFILI SPECIALI	118	3045	PROFILI SPECIALI	119
2101	DISSIPATORE	62	2327	PROFILI SPECIALI	118	3048	PROFILI SPECIALI	115
2111	PROFILI SPECIALI	130	2328	PROFILI SPECIALI	118	3050	PROFILI SPECIALI	115
2113	PROFILI RACLE	121	2329	PROFILI SPECIALI	118	3051	PROFILI SPECIALI	110
2115	DISSIPATORE	11	2331	PROFILI SPECIALI	118	3052	PROFILI SPECIALI	110
2116	DISSIPATORE	59	2332	PROFILI SPECIALI	118	3053	PROFILI SPECIALI	110
2119	DISSIPATORE	6	2333	PROFILI SPECIALI	118	3054	PROFILI SPECIALI	110
2120	PROFILI SPECIALI	122	2334	PROFILI SPECIALI	118	3055	PROFILI SPECIALI	110
2126	CONTENITORE ELETTRONICA	2	2335	PROFILI SPECIALI	118	3056	PROFILI SPECIALI	110
2127	PROFILI SPECIALI	130	2336	PROFILI SPECIALI	118	3057	PROFILI SPECIALI	110
2129	DISSIPATORE	6	2338	PROFILI SPECIALI	118	3058	PROFILI SPECIALI	110
2131	CONTENITORE ELETTRONICA	3	2339	PROFILI SPECIALI	118	3059	PROFILI SPECIALI	110
2134	DISSIPATORE	7	2340	PROFILI SPECIALI	118	3060	PROFILI SPECIALI	110
2136	PROFILI SPECIALI	108	2341	PROFILI SPECIALI	118	3061	PROFILI SPECIALI	110
2139	DISSIPATORE	5	2342	PROFILI SPECIALI	119	3062	PROFILI SPECIALI	110
2142	DISSIPATORE	5	2343	PROFILI SPECIALI	119	3063	PROFILI SPECIALI	110
2144	DISSIPATORE	5	2344	PROFILI SPECIALI	118	3064	PROFILI SPECIALI	114
2148	DISSIPATORE	11	2345	PROFILI SPECIALI	118	3065	PROFILI SPECIALI	110
2154	CONTENITORE ELETTRONICA	3	2346	PROFILI SPECIALI	118	3066	PROFILI SPECIALI	110
2155	DISSIPATORE	23	2347	PROFILI SPECIALI	118	3067	PROFILI SPECIALI	114
2156	CONTENITORE ELETTRONICA	2	2348	PROFILI SPECIALI	118	3068	PROFILI SPECIALI	110
2158	DISSIPATORE	7	2349	PROFILI SPECIALI	118	3069	PROFILI SPECIALI	114
2160	PROFILI SPECIALI	115	2350	PROFILI SPECIALI	118	3070	PROFILI SPECIALI	114
2161	PROFILI SPECIALI	111	2351	PROFILI SPECIALI	118	3071	PROFILI SPECIALI	114
2163	PROFILI RACLE	122	2352	PROFILI SPECIALI	118	3072	PROFILI SPECIALI	110
2165	PROFILI SPECIALI	111	2353	PROFILI SPECIALI	118	3073	PROFILI SPECIALI	110
2170	DISSIPATORE	12	2354	PROFILI SPECIALI	120	3074	PROFILI SPECIALI	110
2176	DISSIPATORE	8	2355	PROFILI SPECIALI	120	3075	PROFILI SPECIALI	110
2181	DISSIPATORE	7	2356	PROFILI SPECIALI	120	3076	PROFILI SPECIALI	110
2183	PROFILI SPECIALI	111	2357	PROFILI SPECIALI	118	3077	PROFILI SPECIALI	111
2187	CONTENITORE ELETTRONICA	2	2358	PROFILI SPECIALI	118	3078	PROFILI SPECIALI	111
2193	DISSIPATORE	10	2448	CONTENITORE ELETTRONICA	1	3079	PROFILI SPECIALI	111
2196	DISSIPATORE	4	2496	CONTENITORE ELETTRONICA	1	3080	PROFILI SPECIALI	111
2197	DISSIPATORE	9	3000	PROFILI STAND	64-118	3081/N	PROFILI SPECIALI	111
2198	DISSIPATORE	5	3001	PROFILI SPECIALI	118	3082/N	PROFILI SPECIALI	109
2200	PROFILI SPECIALI	119	3002	PROFILI SPECIALI	108	3083	PROFILI SPECIALI	126
2202	DISSIPATORE	6	3003	PROFILI SPECIALI	118	3084	PROFILI SPECIALI	126
2203	DISSIPATORE	52	3004	PROFILI SPECIALI	118	3085	PROFILI SPECIALI	126
2210	DISSIPATORE	52	3004-1	PROFILI SPECIALI	118	3086	PROFILI SPECIALI	126
2212	PROFILI COM PONIBILI	70	3005	PROFILI SPECIALI	114	3087	PROFILI SPECIALI	126
2216	DISSIPATORE	5	3006	PROFILI SPECIALI	120	3088	PROFILI SPECIALI	126
2219	DISSIPATORE	4	3007	PROFILI SPECIALI	120	3090	PROFILI SPECIALI	126
2227	DISSIPATORE	60	3008	PROFILI SPECIALI	120	3091	PROFILI SPECIALI	126
2228	DISSIPATORE	109	3010	PROFILI SPECIALI	114	3092	PROFILI SPECIALI	126
2230	PROFILI SPECIALI	114	3011	PROFILI SPECIALI	114	3093	PROFILI SPECIALI	126
2232	CONTENITORE ELETTRONICA	1	3012	PROFILI SPECIALI	114	3097	DISSIPATORE	5
2234	PROFILI SPECIALI	120	3013	PROFILI SPECIALI	114	3098	PROFILI SPECIALI	108
2235	DISSIPATORE	11	3014	PROFILI SPECIALI	114	3099	PROFILI SPECIALI	108
2243	PROFILI COM PONIBILI	66-94	3015	PROFILI SPECIALI	114	3100	PROFILI SPECIALI	109
2248	DISSIPATORE	4	3016	PROFILI SPECIALI	119	3101	PROFILI SPECIALI	108
2249	DISSIPATORE	22	3017	PROFILI SPECIALI	120	3102	PROFILI SPECIALI	108
2254	DISSIPATORE	60	3018	PROFILI SPECIALI	117	3103	PROFILI SPECIALI	109
2258	PROFILI SPECIALI	125	3019	PROFILI SPECIALI	111	3104	PROFILI SPECIALI	108
2260	DISSIPATORE	8	3020	PROFILI SPECIALI	120	3105	PROFILI SPECIALI	108
2266	DISSIPATORE	6	3021	PROFILI SPECIALI	120	3106	PROFILI SPECIALI	108

Índice de artículos

Consulta el Catálogo Online actualizado
en www.omar-alluminio.it

3107	PROFILI SPECIALI	108	3185	PROFILI SPECIALI	108	3267	PROFILI SPECIALI	110
3108	PROFILI SPECIALI	108	3187	PROFILI SPECIALI	120	3269	PROFILI SPECIALI	110
3109	PROFILI SPECIALI	108	3188	PROFILI SPECIALI	108	3270	PROFILI SPECIALI	118
3110	PROFILI SPECIALI	109	3189/N	PROFILI SPECIALI	111	3271	PROFILI RACLE	126
3111	PROFILI SPECIALI	109	3190	PROFILI SPECIALI	119	3272	PROFILI RACLE	126
3112	PROFILI SPECIALI	108	3191	PROFILI SPECIALI	111	3307	PROFILI SPECIALI	114
3113	PROFILI SPECIALI	108	3192	PROFILI SPECIALI	119	3308	PROFILI SPECIALI	126
3114	PROFILI SPECIALI	108	3193	PROFILI SPECIALI	111	3309	PROFILI SPECIALI	126
3115	PROFILI SPECIALI	109	3194	PROFILI SPECIALI	111	3310	PROFILI SPECIALI	109
3116	PROFILI SPECIALI	109	3195	PROFILI SPECIALI	111	3311	PROFILI SPECIALI	116
3117	PROFILI SPECIALI	130	3197	PROFILI SPECIALI	111	3312	PROFILI SPECIALI	116
3118	PROFILI SPECIALI	109	3199	PROFILI SPECIALI	111	3313	PROFILI SPECIALI	116
3119	PROFILI SPECIALI	109	3200	PROFILI SPECIALI	127	3314	PROFILI SPECIALI	121
3120	PROFILI SPECIALI	109	3201	PROFILI SPECIALI	127	3315	PROFILI SPECIALI	116
3121	PROFILI SPECIALI	109	3202	PROFILI SPECIALI	109	3316	PROFILI SPECIALI	116
3122	PROFILI SPECIALI	109	3203	PROFILI SPECIALI	115	3317	PROFILI SPECIALI	116
3123	PROFILI SPECIALI	109	3204	PROFILI SPECIALI	115	3318	PROFILI SPECIALI	117
3124/N	PROFILI SPECIALI	109	3205	PROFILI SPECIALI	115	3319	PROFILI SPECIALI	119
3125	PROFILI SPECIALI	111	3209	PROFILI SPECIALI	115	3320	PROFILI SPECIALI	119
3126	PROFILI SPECIALI	109	3210	PROFILI SPECIALI	115	3321	PROFILI SPECIALI	119
3127	PROFILI SPECIALI	130	3211	PROFILI SPECIALI	115	3322	PROFILI SPECIALI	119
3128	PROFILI SPECIALI	109	3212	PROFILI SPECIALI	115	3323	PROFILI SPECIALI	119
3129/N	PROFILI SPECIALI	111	3213	PROFILI SPECIALI	115	3324	PROFILI SPECIALI	119
3130	PROFILI SPECIALI	109	3214	PROFILI SPECIALI	115	3325	PROFILI SPECIALI	119
3131	PROFILI SPECIALI	109	3215	PROFILI SPECIALI	108	3326	PROFILI SPECIALI	119
3132	PROFILI SPECIALI	111	3216	PROFILI SPECIALI	111	3327	PROFILI SPECIALI	110
3133	PROFILI SPECIALI	114	3217	PROFILI SPECIALI	109	3328	PROFILI SPECIALI	110
3135	PROFILI SPECIALI	114	3218	PROFILI SPECIALI	108	3329	PROFILI SPECIALI	110
3137	PROFILI SPECIALI	111	3219	PROFILI SPECIALI	108	3330	PROFILI SPECIALI	110
3138	PROFILI SPECIALI	111	3220	PROFILI SPECIALI	109	3332	PROFILI SPECIALI	110
3140	PROFILI SPECIALI	114	3221	PROFILI SPECIALI	107	3333	PROFILI SPECIALI	111
3141/N	PROFILI SPECIALI	108	3222	PROFILI SPECIALI	107	3334	PROFILI SPECIALI	119
3142	PROFILI SPECIALI	120	3223	PROFILI SPECIALI	107	3335	PROFILI SPECIALI	118
3143	PROFILI SPECIALI	108	3224	PROFILI SPECIALI	107	3336	PROFILI SPECIALI	117
3144	PROFILI SPECIALI	108	3225	PROFILI SPECIALI	107	3337	PROFILI SPECIALI	111
3145	PROFILI SPECIALI	120	3226	PROFILI SPECIALI	108	3338	PROFILI SPECIALI	111
3146	PROFILI SPECIALI	120	3227	PROFILI SPECIALI	120	3339	PROFILI SPECIALI	116
3147	PROFILI SPECIALI	125	3229	PROFILI SPECIALI	130	3340	PROFILI SPECIALI	117
3148	PROFILI SPECIALI	115	3230	PROFILI SPECIALI	108	3341	TENDE PER INTERNI	129
3149	PROFILI SPECIALI	115	3231	PROFILI SPECIALI	114	3342	TENDE PER INTERNI	129
3150	PROFILI SPECIALI	115	3232	PROFILI SPECIALI	111	3343	TENDE PER INTERNI	129
3151	PROFILI SPECIALI	115	3234	PROFILI SPECIALI	126	3344	TENDE PER INTERNI	129
3152	PROFILI SPECIALI	109	3235	PROFILI SPECIALI	126	3345	TENDE PER INTERNI	129
3153	PROFILI SPECIALI	111	3236	PROFILI SPECIALI	126	3346	TENDE PER INTERNI	129
3154	PROFILI SPECIALI	111	3237	PROFILI SPECIALI	108	3347	TENDE PER INTERNI	129
3155	PROFILI SPECIALI	111	3238	PROFILI SPECIALI	108	3348	TENDE PER INTERNI	129
3156	PROFILI SPECIALI	107	3239	PROFILI SPECIALI	111	3349	TENDE PER INTERNI	129
3159	PROFILI SPECIALI	125	3240	PROFILI SPECIALI	110	3350	TENDE PER INTERNI	129
3160	PROFILI SPECIALI	115	3241	PROFILI SPECIALI	110	3351	TENDE PER INTERNI	129
3161	PROFILI SPECIALI	115	3242	PROFILI SPECIALI	110	3354	TENDE PER INTERNI	129
3162	PROFILI SPECIALI	107	3243	PROFILI SPECIALI	110	3355	TENDE PER INTERNI	129
3163	PROFILI SPECIALI	111	3245	PROFILI SPECIALI	110	3356	TENDE PER INTERNI	129
3164	PROFILI SPECIALI	109	3246	PROFILI SPECIALI	110	3357	TENDE PER INTERNI	129
3165	PROFILI SPECIALI	111	3247	PROFILI SPECIALI	110	3358	TENDE PER INTERNI	129
3166	PROFILI SPECIALI	111	3248	PROFILI SPECIALI	110	3359	TENDE PER INTERNI	129
3167	PROFILI SPECIALI	115	3249	PROFILI SPECIALI	110	3360	PROFILI SPECIALI	130
3168	PROFILI SPECIALI	109	3250	PROFILI SPECIALI	110	3361	PROFILI SPECIALI	130
3169	PROFILI SPECIALI	111	3251	PROFILI SPECIALI	118	3362	PROFILI SPECIALI	130
3170	PROFILI SPECIALI	110	3252	PROFILI SPECIALI	110	3363	PROFILI SPECIALI	130
3171	PROFILI SPECIALI	108	3253	PROFILI SPECIALI	110	3364	PROFILI SPECIALI	130
3172	PROFILI SPECIALI	115	3254	PROFILI SPECIALI	119	3365	PROFILI SPECIALI	130
3173	PROFILI SPECIALI	109	3256	PROFILI SPECIALI	119	3366	PROFILI SPECIALI	130
3174	PROFILI SPECIALI	111	3257	PROFILI SPECIALI	110	3367	PROFILI SPECIALI	130
3175	PROFILI SPECIALI	111	3259	PROFILI SPECIALI	110	3368	PROFILI SPECIALI	130
3177	PROFILI SPECIALI	108	3260	PROFILI SPECIALI	110	3369	PROFILI SPECIALI	131
3178	PROFILI SPECIALI	109	3261	PROFILI SPECIALI	110	3370	PROFILI SPECIALI	131
3179	PROFILI SPECIALI	109	3262	PROFILI SPECIALI	110	3371	PROFILI SPECIALI	131
3180	PROFILI SPECIALI	111	3263	PROFILI SPECIALI	110	3372	PROFILI SPECIALI	131
3181	PROFILI SPECIALI	111	3264	PROFILI SPECIALI	110	3373	PROFILI SPECIALI	131
3182	PROFILI SPECIALI	114	3265	PROFILI SPECIALI	114	3374	PROFILI SPECIALI	131
3184	PROFILI SPECIALI	114	3266	PROFILI SPECIALI	110	3375	PROFILI SPECIALI	131

Via Newton, n.12
20016 Pero (Milano - Italy)
Tel. +39 02 3535955 r.a. Fax. +39 02 3539929
E-Mail: info@omar-alluminio.it

Cataloghi Online: www.omar-alluminio.it
www.omar-alluminio.com

PERFILI DI ALUMINIO A MISURA / ESTÁNDAR / ESPECIAL / Y PARA:
ELECTRÓNICA / LED / FOTOVOLTAICA / AUTOMATIZACIÓN ROBÓTICA / NEUMÁTICA / AUTOMOCIÓN



Consulta el Catálogo Online actualizado
 en www.omar-alluminio.it

Índice de artículos

3376	PROFILI SPECIALI	131	PNP94100	PROFILI PNEUMATICI	85		
3377	PROFILI SPECIALI	131	PNP9416	PROFILI PNEUMATICI	85		
3378	PROFILI SPECIALI	131	PNP9420	PROFILI PNEUMATICI	85		
3379	PROFILI SPECIALI	131	PNP9425	PROFILI PNEUMATICI	85		
3380	PROFILI SPECIALI	131	PNP9432	PROFILI PNEUMATICI	85		
3381	PROFILI SPECIALI	131	PNP9440	PROFILI PNEUMATICI	85		
3382	PROFILI SPECIALI	131	PNP9450	PROFILI PNEUMATICI	85		
3383	PROFILI SPECIALI	131	PNP9463	PROFILI PNEUMATICI	85		
3384	PROFILI SPECIALI	131	PNP9480	PROFILI PNEUMATICI	85		
3385	PROFILI SPECIALI	131	PNR99100	PROFILI PNEUMATICI	84		
3386	PROFILI SPECIALI	131	PNR99125	PROFILI PNEUMATICI	84		
3387	PROFILI SPECIALI	131	PNR9932	PROFILI PNEUMATICI	84		
3388	PROFILI SPECIALI	131	PNR9940	PROFILI PNEUMATICI	84		
3389	PROFILI SPECIALI	131	PNR9950	PROFILI PNEUMATICI	84		
3390	PROFILI SPECIALI	131	PNR9963	PROFILI PNEUMATICI	84		
3672	CONTENITORE ELETTRONICA	1	PNR9980	PROFILI PNEUMATICI	84		
3696	CONTENITORE ELETTRONICA	1	PNT100106	PROFILI PNEUMATICI	86		
4848	CONTENITORE ELETTRONICA	1	PNT100107	PROFILI PNEUMATICI	86		
4896	CONTENITORE ELETTRONICA	1	PNT105110	PROFILI PNEUMATICI	86		
7272	CONTENITORE ELETTRONICA	1	PNT1216	PROFILI PNEUMATICI	86		
9696	CONTENITORE ELETTRONICA	1	PNT125131	PROFILI PNEUMATICI	86		
36144	CONTENITORE ELETTRONICA	1	PNT125132	PROFILI PNEUMATICI	86		
48192	CONTENITORE ELETTRONICA	2	PNT150160	PROFILI PNEUMATICI	86		
50144	CONTENITORE ELETTRONICA	1	PNT160167	PROFILI PNEUMATICI	86		
72144	CONTENITORE ELETTRONICA	1	PNT160170	PROFILI PNEUMATICI	86		
96192	CONTENITORE ELETTRONICA	2	PNT1620	PROFILI PNEUMATICI	86		
PNC100	PROFILI PNEUMATICI	87	PNT200210	PROFILI PNEUMATICI	86		
PNC25	PROFILI PNEUMATICI	87	PNT2024	PROFILI PNEUMATICI	86		
PNC32	PROFILI PNEUMATICI	87	PNT2025	PROFILI PNEUMATICI	86		
PNC40	PROFILI PNEUMATICI	87	PNT2529	PROFILI PNEUMATICI	86		
PNC50	PROFILI PNEUMATICI	87	PNT2530	PROFILI PNEUMATICI	86		
PNC63	PROFILI PNEUMATICI	87	PNT3236	PROFILI PNEUMATICI	86		
PNC80	PROFILI PNEUMATICI	87	PNT3238	PROFILI PNEUMATICI	86		
PNCT100	PROFILI PNEUMATICI	88	PNT3540	PROFILI PNEUMATICI	86		
PNCT25	PROFILI PNEUMATICI	88	PNT3640	PROFILI PNEUMATICI	86		
PNCT32	PROFILI PNEUMATICI	88	PNT4044	PROFILI PNEUMATICI	86		
PNCT40	PROFILI PNEUMATICI	88	PNT4045	PROFILI PNEUMATICI	86		
PNCT50	PROFILI PNEUMATICI	88	PNT5054	PROFILI PNEUMATICI	86		
PNCT63	PROFILI PNEUMATICI	88	PNT5055	PROFILI PNEUMATICI	86		
PNCT80	PROFILI PNEUMATICI	88	PNT5057	PROFILI PNEUMATICI	86		
PNLG100	PROFILI PNEUMATICI	89	PNT5060	PROFILI PNEUMATICI	86		
PNLG125	PROFILI PNEUMATICI	89	PNT5560	PROFILI PNEUMATICI	86		
PNLG32	PROFILI PNEUMATICI	89	PNT5660	PROFILI PNEUMATICI	86		
PNLG40	PROFILI PNEUMATICI	89	PNT6065	PROFILI PNEUMATICI	86		
PNLG50	PROFILI PNEUMATICI	89	PNT6367	PROFILI PNEUMATICI	86		
PNLG63	PROFILI PNEUMATICI	89	PNT6368	PROFILI PNEUMATICI	86		
PNLG80	PROFILI PNEUMATICI	89	PNT6570	PROFILI PNEUMATICI	86		
PNM80100	PROFILI PNEUMATICI	79	PNT7075	PROFILI PNEUMATICI	86		
PNM80125	PROFILI PNEUMATICI	79	PNT7580	PROFILI PNEUMATICI	86		
PNM8020	PROFILI PNEUMATICI	79	PNT8085	PROFILI PNEUMATICI	86		
PNM8025	PROFILI PNEUMATICI	79	PNT8086	PROFILI PNEUMATICI	86		
PNM8032	PROFILI PNEUMATICI	79	PNT8590	PROFILI PNEUMATICI	86		
PNM8040	PROFILI PNEUMATICI	79	PNT9095	PROFILI PNEUMATICI	86		
PNM8050	PROFILI PNEUMATICI	79	PNT9097	PROFILI PNEUMATICI	86		
PNM8063	PROFILI PNEUMATICI	79	PNT95100	PROFILI PNEUMATICI	86		
PNM8080	PROFILI PNEUMATICI	79	PR30X3,6X1,8	TENDE PER INTERNI	129		
PNM89100	PROFILI PNEUMATICI	82	PR40X3X1,5	TENDE PER INTERNI	129		
PNM89125	PROFILI PNEUMATICI	82	PR40X3,6X1,8	TENDE PER INTERNI	129		
PNM89160	PROFILI PNEUMATICI	83	TR200X20/S	PROFILI SPECIALI	112		
PNM89200	PROFILI PNEUMATICI	83	TR200X25/S	PROFILI SPECIALI	112		
PNM8932	PROFILI PNEUMATICI	81	TR200X50/S	PROFILI SPECIALI	112		
PNM8940	PROFILI PNEUMATICI	81	TR200X70/S	PROFILI SPECIALI	112		
PNM8950	PROFILI PNEUMATICI	81	TR270X40/S	PROFILI SPECIALI	112		
PNM8963	PROFILI PNEUMATICI	81	TR300X50/S	PROFILI SPECIALI	113		
PNM8980	PROFILI PNEUMATICI	81	TR300X80/S	PROFILI SPECIALI	113		
PNM90100	PROFILI PNEUMATICI	80	TR330X35/S	PROFILI SPECIALI	113		
PNM9032	PROFILI PNEUMATICI	80					
PNM9040	PROFILI PNEUMATICI	80					
PNM9050	PROFILI PNEUMATICI	80					
PNM9063	PROFILI PNEUMATICI	80					
PNM9080	PROFILI PNEUMATICI	80					



Tipo di matrici di estrusione

Extrusion tools

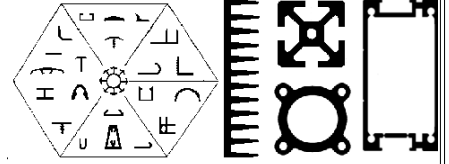

A) matriz plana para perfil abierto

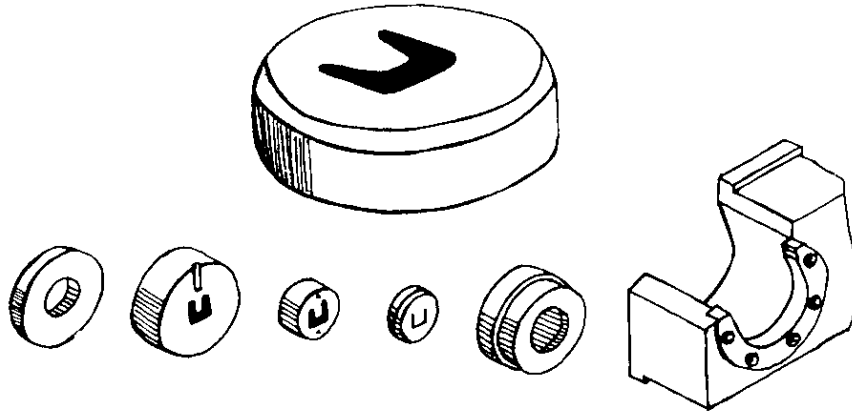

B) Matriz Spyder para perfil hueco

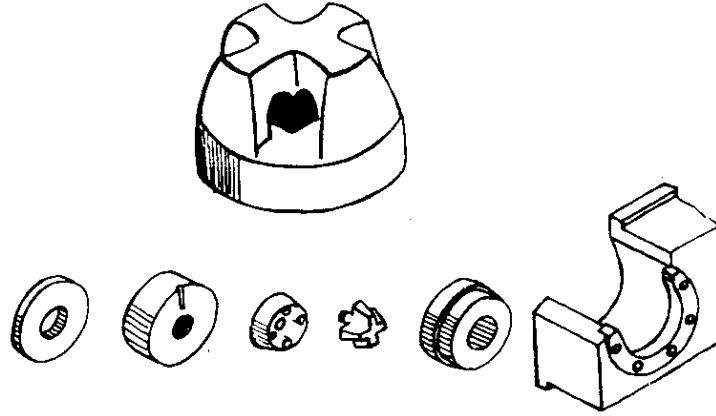

C) Conjunto de ojos de buey para perfil hueco

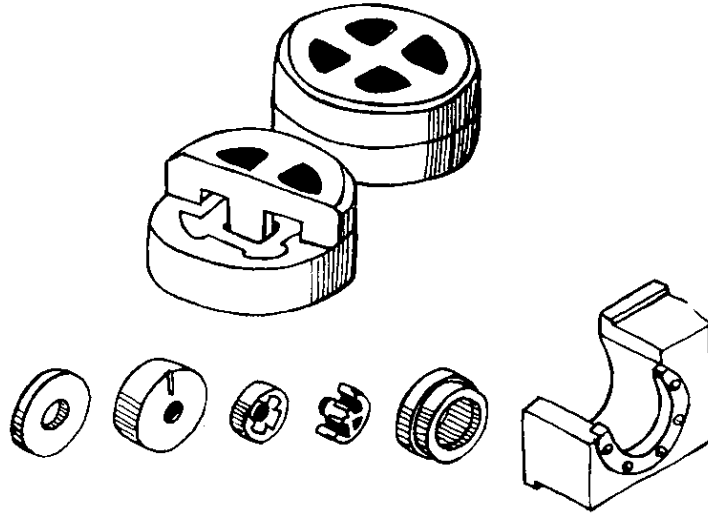

D) matriz de puente similar a ojo de buey para perfil hueco

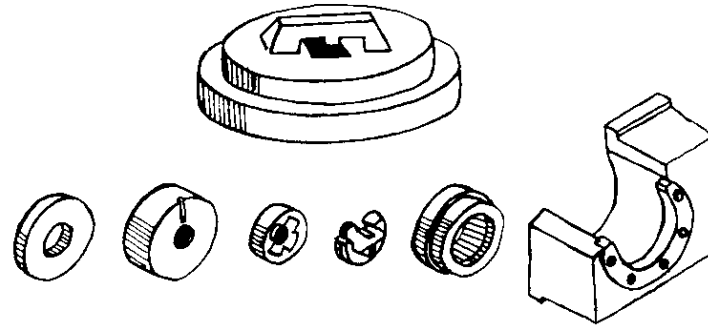

Via Newton, n.12

20016 Pero (Milano - Italy)

Tel. +39 02 3535955 r.a. Fax. +39 02 3539929

E-Mail: info@omar-alluminio.it

Cataloghi Online: www.omar-alluminio.it

www.omar-alluminio.com

PERFILES DE ALUMINIO A MEDIDA / ESTÁNDAR / ESPECIAL / Y PARA:

ELECTRÓNICA / LED / FOTOVOLTAICA / AUTOMATIZACIÓN ROBÓTICA / NEUMÁTICA / AUTOMOCIÓN

omar s.r.l.
PROFILATI ALLUMINIO
ALTA TECNOLOGIA



- DIMENSIONES MÁXIMAS EXTRUDIBLES -

SCALA 1:3

470

330

R145

R90

PRESSA 3200 TON

PRESSA 6050 TON

450

630

Cataloghi Online: www.omar-alluminio.it

www.omar-alluminio.com

PERFILES DE ALUMINIO A MEDIDA / ESTÁNDAR / ESPECIAL / Y PARA:

ELECTRÓNICA / LED / FOTOVOLTAICA / AUTOMATIZACIÓN ROBÓTICA / NEUMÁTICA / AUTOMOCIÓN

Via Newton, n.12

20016 Pero (Milano - Italy)

Tel. +39 02 3535955 r.a. Fax. +39 02 3539929

E.Mail: info@omar-alluminio.it

OMAR s.r.l.
PROFILATI ALLUMINIO
ALTA TECNOLOGIA

Principales aleaciones de extrusión.

Propiedades de la aleación de aluminio extruido

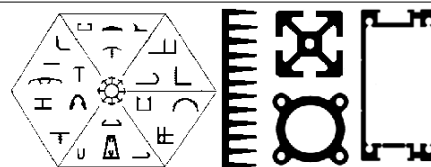

LEGA DI ALLUMINIO DA ESTRUSIONE EN AW-6060

La lega EN AW 6060 è lega da estrusione più diffusa sul mercato europeo, per le sue doti di alta velocità di deformazione a caldo.

Essa consente la realizzazione di profilati con sezione anche complessa, comprendente cavità e scanalature, per avvicinare quanto più possibile il disegno dell'estruso a quello del manufatto finito, e ridurre al minimo le lavorazioni intermedie.

Essa inoltre presenta ottima resistenza alla corrosione ambientale, anche in atmosfera industriale e marina.

Caratteristiche fisiche

Massa volumica	2,70	Gr/cm3	Conducibilità termica a 20°C	Nello stato 0: 2,09 W/cm °Kelvin Nello stato T6: 1,75 W/cm °Kelvin
Punto di fusione inferiore	605	C	Coeff. Di dilatazione termica lineare	Tra 20° e 100°C: 23,0 -10-6 1/°Kelvin Tra 20° e 200°C: 24,0 -10-6 1/°Kelvin Tra 20° e 300°C: 25,0 -10-6 1/°Kelvin
Calore specifico tra 0° e 100°C	890	Joule/Kg °Kelvin	Resistività elettrica a 20°C	Nello stato 0: 3,14 microOhm *cm Nello stato T6: 3,25 microOhm *cm
Modulo di elasticità lineare E	69000	Newton/mm2		
Modulo di elasticità tangenziale G	26000	Newton/mm2		

Tipo profilo	(1) stato fisico di fornitura	Diametro D		Carico	Di rottura a	Carico di	Rottura a	Allungamento	
		o spess. S	[mm] per tonde,					Trazione	Rm [Mpa]
		o spess. Di parete	e per profili	min	max	min	max	min	max
tondi e barre piane	T4 (*)	D ≤150	S ≤150	120	-	60	-	16	14
	T5	D ≤150	S ≤150	160	-	120	-	8	6
	T6 (*)	D ≤150	S ≤150	190	-	150	-	8	6
	T64 (*)	D ≤50	S ≤50	180	-	120	-	12	10
	T66 (*)	D ≤150	S ≤150	215	-	160	-	8	6
tubi	T4(*)	e ≤15		120	-	60	-	16	14
	T5	e ≤15		160	-	120	-	8	6
	T6(*)	e ≤15		190	-	150	-	8	6
	T64(*)	e ≤15		180	-	120	-	12	10
	T66(*)	e ≤15		215	-	160	-	8	6
Profili aperti e cavi	T4 (*)	e ≤25		120	-	60	-	16	14
	T5	e ≤5		160	-	120	-	8	6
		5 < e ≤ 25		140	-	100	-	8	6
	T6 (*)	e ≤3		190	-	150	-	8	6
		3 < e ≤ 25		170	-	140	-	8	6
	T64 (*)	e ≤15		180	-	120	-	12	10
	T66 (*)	e ≤3		215	-	160	-	8	6
3 < e ≤ 25			195	-	150	-	8	6	

LEGA	Stato fisico	Deformabilità plastica		Lavorabilità su macchina utensile	Saldabilità	Lucidabilità	Ossidazione	anodica		Resistenza alla corrosione		
		a freddo	a caldo					protettiva	decorativa	urbana	industriale	marina
EN AW-3103	F,H 112	2	1	5	3	4	3	3	1	1	2	
	O,H 111	2	1	5	3	4	3	3	1	1	2	
EN AW-6060	O	2	1	5	2	4	1	2	1	2	2	
	T1,T4	3	2	4	2	3	1	1	1	2	2	
	T5,T6	4	X	3	2	2	1	1	1	2	2	
EN AW-6063	O,H 111	2	1	5	2	4	1	2	2	2	3	
	T4	3	2	4	2	3	1	1	2	2	3	
	T5,T6	4	X	3	2	2	1	1	2	2	3	
EN AW-6005A	O	2	1	4	2	3	2	4	2	3	3	
	T4	3	2	3	2	2	2	3	2	3	3	
	T5,T6	4	X	2	2	1	2	3	2	3	3	
EN AW-6082	O,H 111	2	1	4	2	3	2	3	3	3	3	
	T4	3	2	3	2	2	2	2	3	3	3	
	T5,T6	4	X	2	2	1	2	2	3	3	3	

INDICE DE EVALUACIÓN: 1=EXCELENTE 2=BUENO 3=SUFICIENTE 4=MEDIOCRE 5=MALO
ESTADOS T5 Y T6

Via Newton, n.12
20016 Pero (Milano - Italy)
Tel. +39 02 3539929
E-Mail: info@omar-alluminio.it

Cataloghi Online: www.omar-alluminio.it

www.omar-alluminio.com

PERFILES DE ALUMINIO A MEDIDA / ESTÁNDAR / ESPECIAL / Y PARA:

ELECTRÓNICA / LED / FOTOVOLTAICA / AUTOMATIZACIÓN ROBÓTICA / NEUMÁTICA / AUTOMOCIÓN



FIERA MILANO RHO - PERO

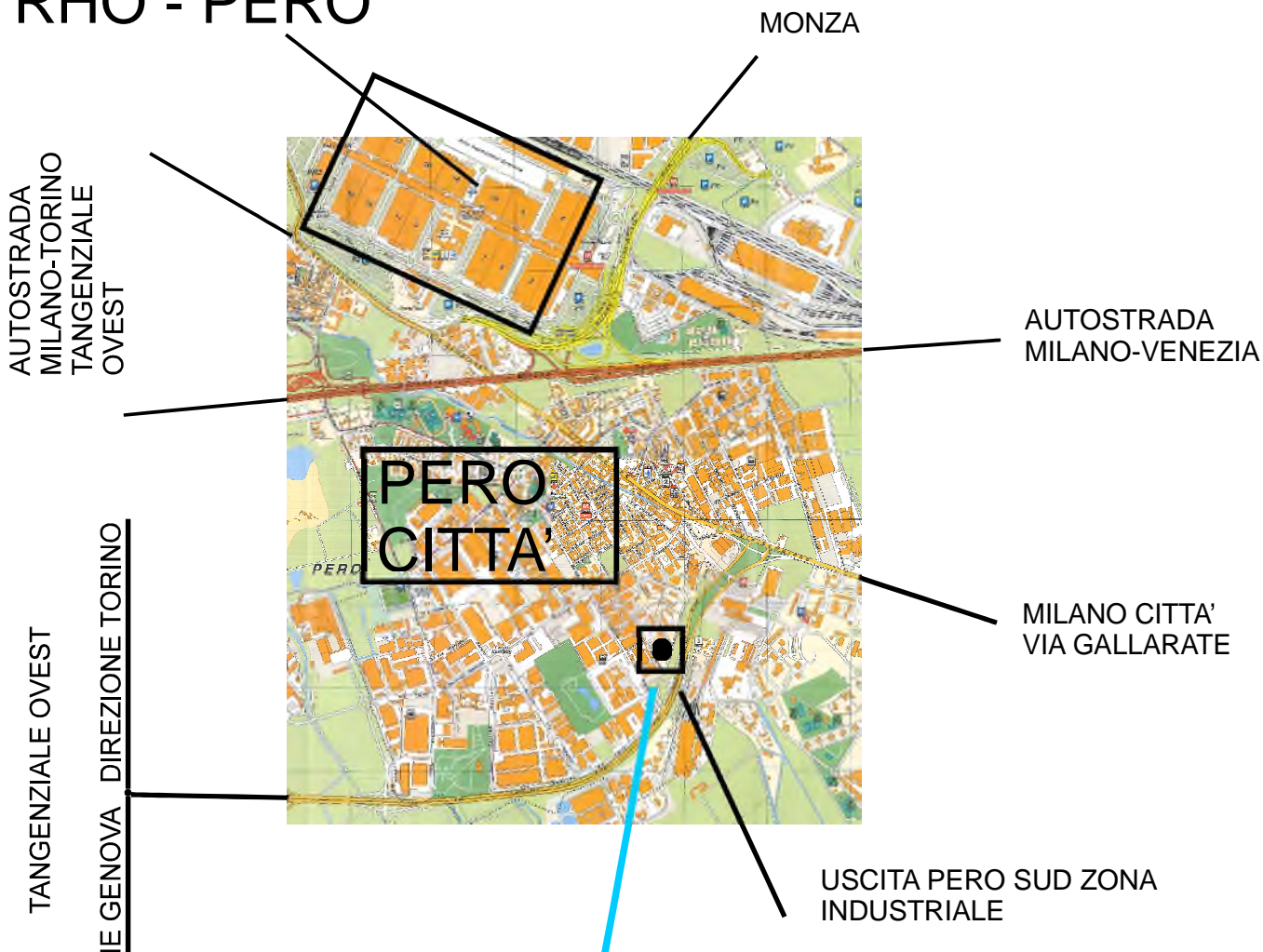

OMAR s.r.l.
PROFILATI ALLUMINIO
ALTA TECNOLOGIA

Via Newton, n.12
20016 Pero (Milano - Italy)
Tel.+39 02 3535955 r.a.
Fax.+39 02 3539929
E.Mail: info@omar-alluminio.it

Consulta nuestro. catálogo actualizado en línea en:

www.omar-alluminio.it
www.omar-alluminio.com
www.omar-alluminio.eu

PERFILES DE ALUMINIO
POR DIBUJO-ESTÁNDAR-ESPECIAL



Y PARA: ELECTRÓNICA-LED-FOTOVOLTAICA
AUTOMATIZACIÓN ROBÓTICA-NEUMÁTICA-AUTOMOTIVA