

- °Perfiles normalizados de aluminio
- Perfiles de aluminio especiales
- °Disipador-Radiador Térmico de Aluminio
- °disipadores de grandes dimensiones high-dissipation aluminium profiles heat sinks
- °disipador de calor para LED
- °CNC Machining Parts
- °gabinetes para electronica de aluminio
- °Perfiles modulares de aluminio

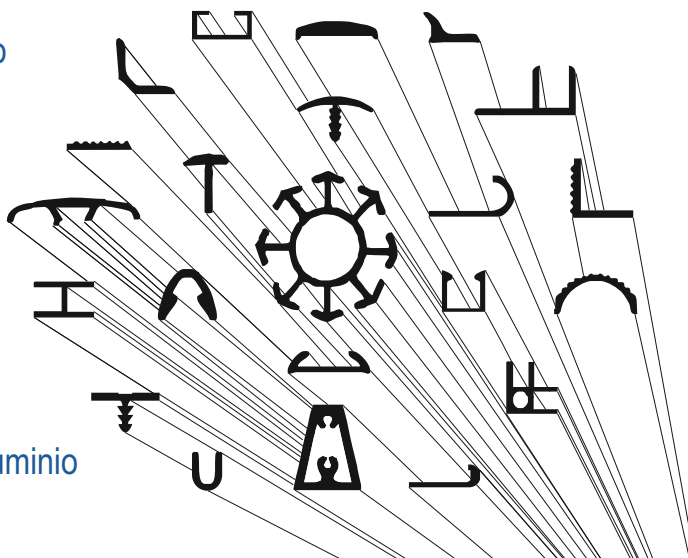

OMAR s.r.l.
PROFILATI ALLUMINIO
ALTA TECNOLOGIA

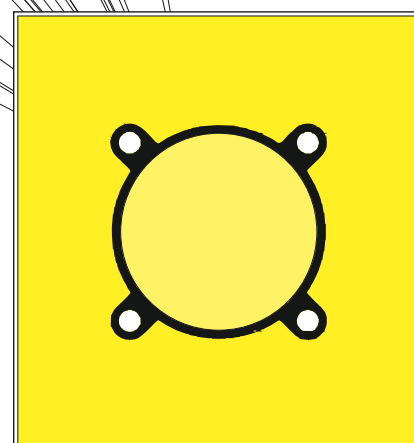

Le "molte forme" della billetta d'alluminio
Tuberías para sistemas neumáticos

Edizione Marzo 2023

Consultate il catalogo aggiornato online su:

www.omar-alluminio.it

www.omar-alluminio.com

www.pneumatica.sm

- °Perfiles para neumática
- °Perfiles para stands de exposición
- °Perfiles para rodapiés cubiertas de alambre para rodapiés
- °Productos derivados de perfiles de aluminio
- °Procesamiento mecánico perfiles de aluminio

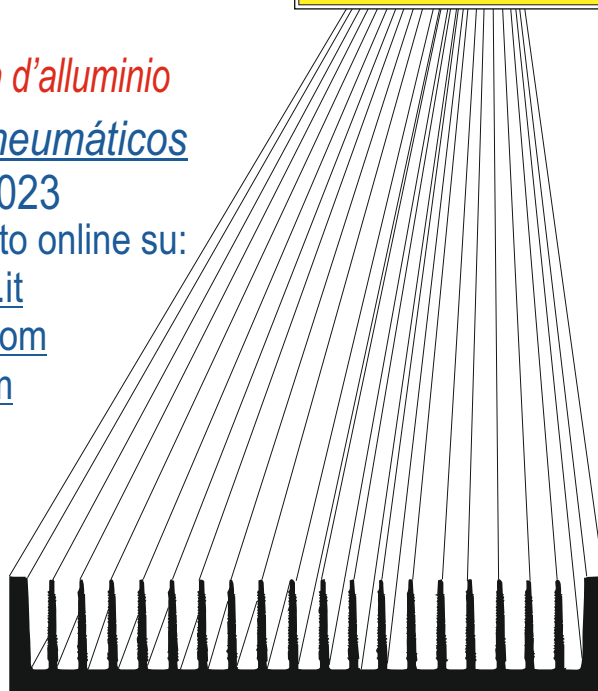

Via Newton, n.12
20016 Pero (Milano - Italy)
Tel.+39 02 3535955 r.a.
Fax.+39 02 3539929
E.Mail: info@omar-alluminio.it

PROFILATI IN ALLUMINIO
 A DISEGNO-STANDARD-SPECIALI



ED: ELETTRONICA-LED-FOTOVOLTAICO
 AUTOMAZIONE-ROBOTICA-PNEUMATICA-AUTOMOTIVE

Profili componibili per banchi e linee modulari

Profili strutturali - Extruded aluminium sections for modular systems

Gamma completa per:

- Profili in alluminio con ossidazione naturale in barre o tagliati a misura
- Accessori adatti alla realizzazione di strutture modulari (passare a pag.137 per la descrizione degli accessori)



DISEGNI META' DEL VERO (1:2)

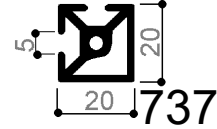
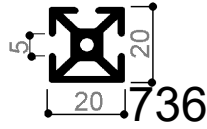
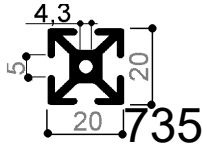

FORI PER FILETTO M5

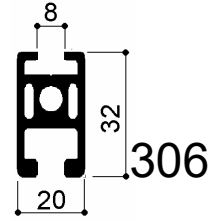
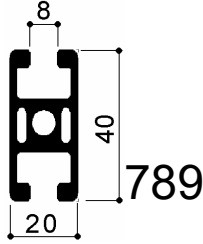
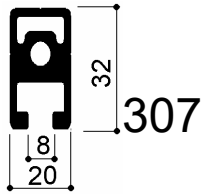

Profili componibili per banchi e linee modulari

Profili strutturali - Extruded aluminium sections for modular systems

Gamma completa per:

- Profili in alluminio con ossidazione naturale in barre o tagliati a misura
- Accessori adatti alla realizzazione di strutture modulari (passare a pag.135 per la descrizione degli accessori)



DISEGNI META' DEL VERO (1:2)- SCALE 1:2

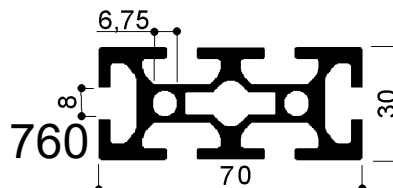
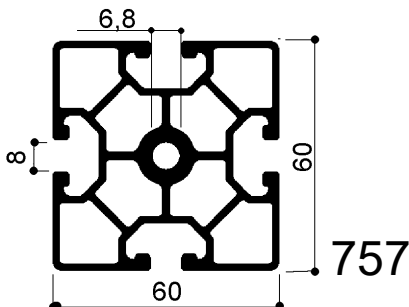
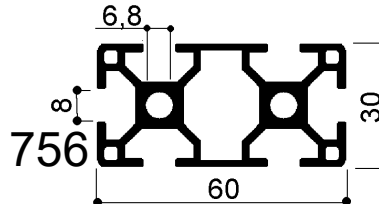
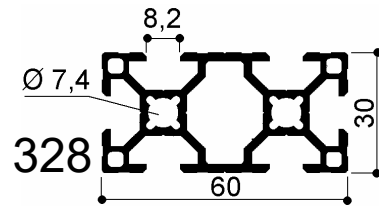
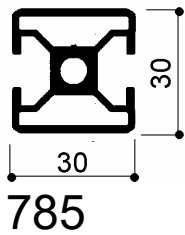
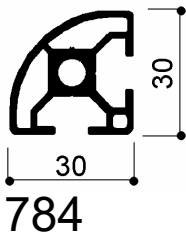
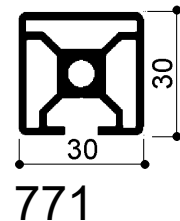
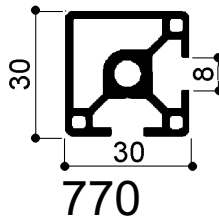
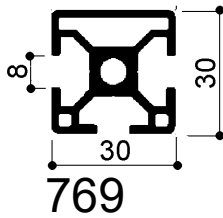
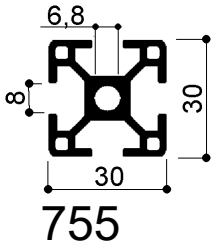

FORI PER FILETTO M8

Via Newton, n.12
20016 Pero (Milano - Italy)
Tel. +39 02 3535955 r.a. Fax. +39 02 3539929
E-Mail: info@omar-alluminio.it

Cataloghi Online: www.omar-alluminio.it
www.omar-alluminio.com

PROFILATI ALLUMINIO A DISEGNO / STANDARD / SPECIALI / E PER:
ELETTRONICA / LED / FOTOVOLTAICO / AUTOMAZIONE ROBOTICA / PNEUMATICA / AUTOMOTIVE



Profili componibili per banchi e linee modulari

Profili strutturali - Extruded aluminium sections for modular systems

Gamma completa per:

- Profili in alluminio con ossidazione naturale in barre o tagliati a misura
- Accessori adatti alla realizzazione di strutture modulari (passare a pag.137 per la descrizione degli accessori)

SERIE
40

DISEGNI META' DEL VERO (1:2)- SCALE 1:2

FORI PER FILETTO M8

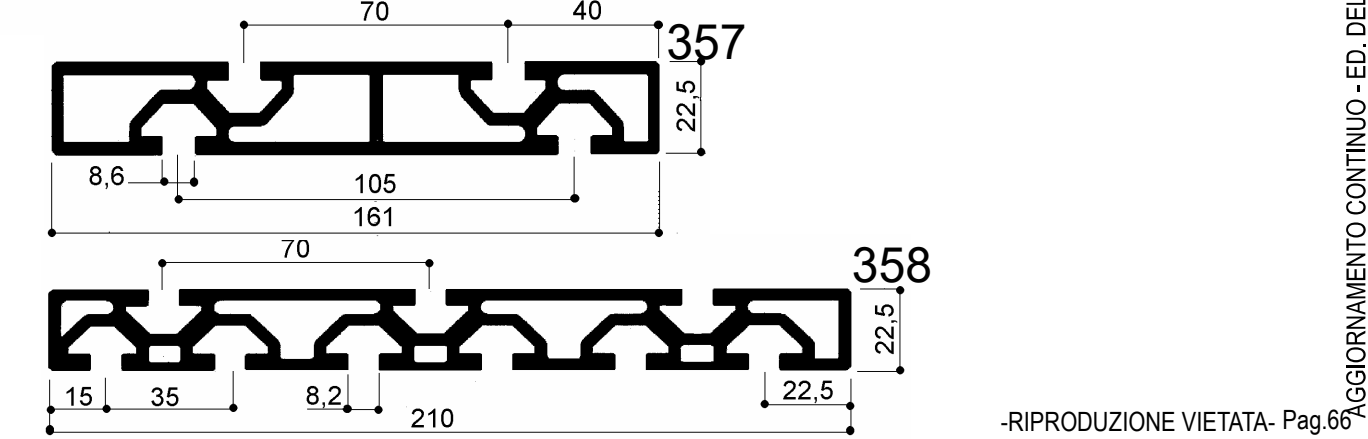
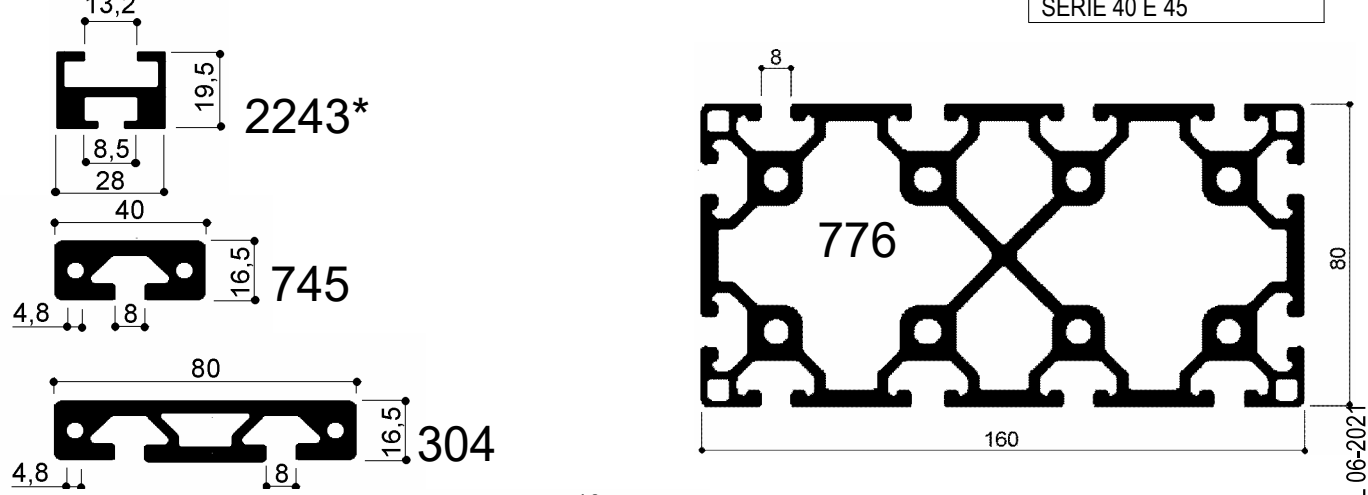
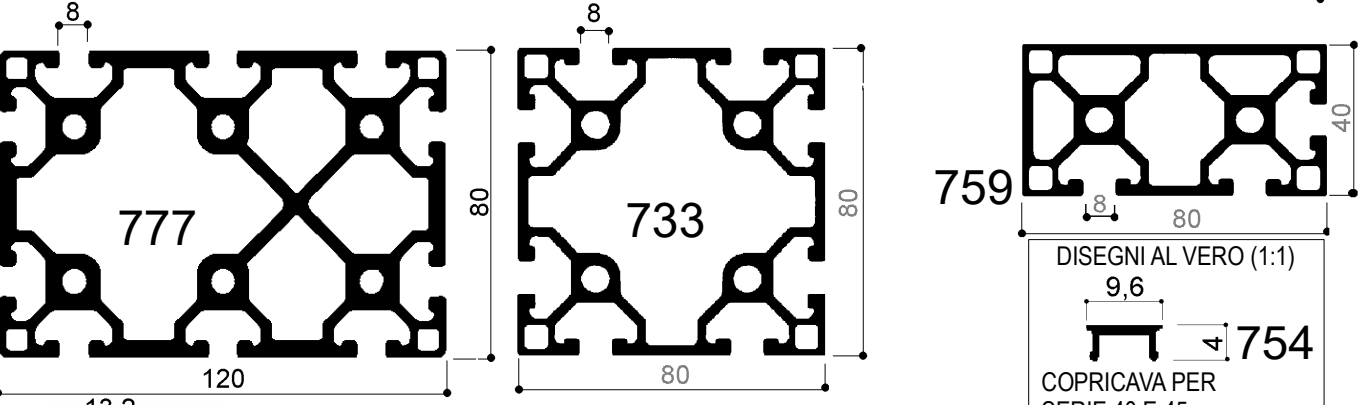
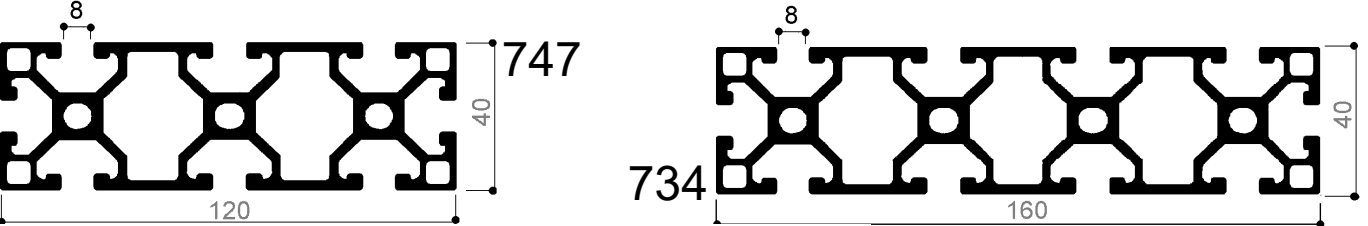
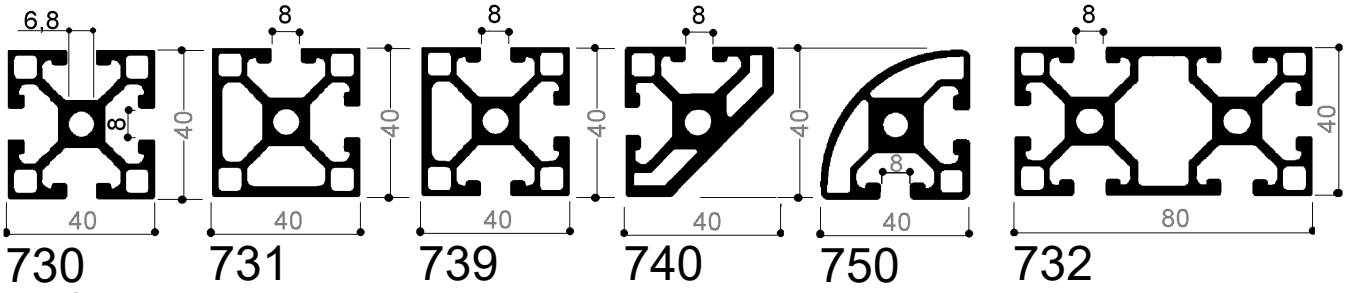

Via Newton, n.12

20016 Pero (Milano - Italy)

Tel. +39 02 3535955 r.a. Fax. +39 02 3539929

E. Mail: info@omar-alluminio.it

Cataloghi Online: www.omar-alluminio.it

www.omar-alluminio.com

PROFILATI ALLUMINIO A DISEGNO / STANDARD / SPECIALI / E PER:

ELETRONICA / LED / FOTOVOLTAICO / AUTOMAZIONE ROBOTICA / PNEUMATICA / AUTOMOTIVE

OMAR s.r.l.
PROFILATI ALLUMINIO
ALTA TECNOLOGIA



Profili componibili per banchi e linee modulari

Profili strutturali - Extruded aluminium sections for modular systems

Gamma completa per:

-Profili in alluminio con ossidazione naturale in barre o tagliati a misura

-Accessori adatti alla realizzazione di strutture modulari

(passare a pag.137 per la descrizione degli accessori)



SERIE

40

DISEGNI META' DEL VERO (1:2)

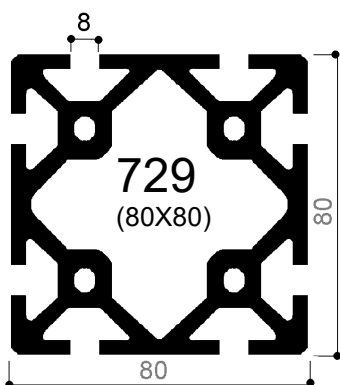
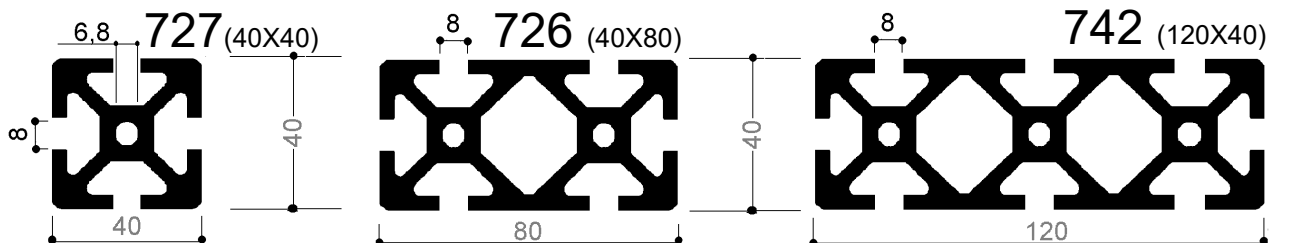

FORI PER
FILETTO M8

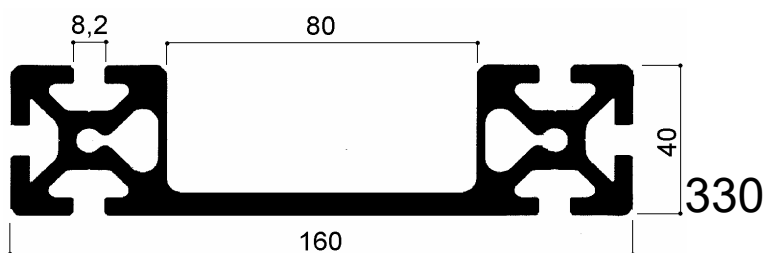
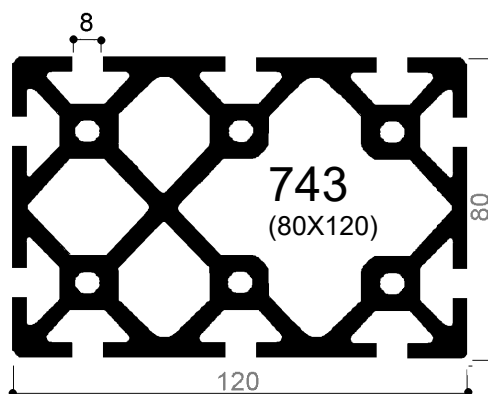
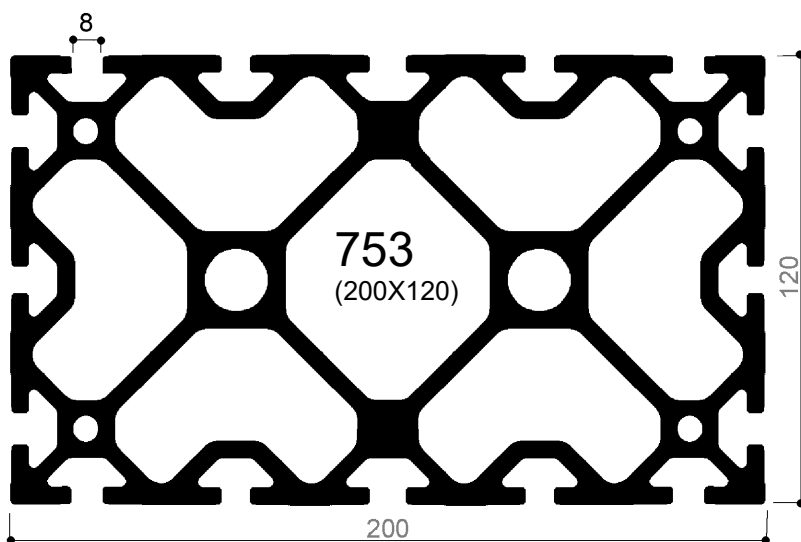
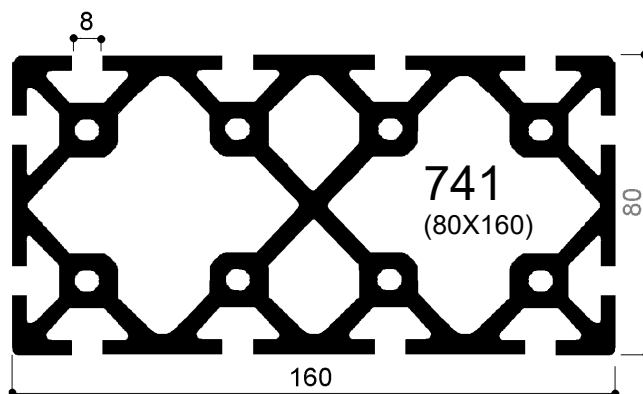

Via Newton, n.12

20016 Pero (Milano - Italy)

Tel. +39 02 3535955 r.a. Fax. +39 02 3539929

E-Mail: info@omar-alluminio.it

Cataloghi Online: www.omar-alluminio.it

www.omar-alluminio.com

PROFILATI ALLUMINIO A DISEGNO / STANDARD / SPECIALI / E PER:

ELETTRONICA / LED / FOTOVOLTAICO / AUTOMAZIONE ROBOTICA / PNEUMATICA / AUTOMOTIVE



Profili componibili per banchi e linee modulari

Profili strutturali - Extruded aluminium sections for modular systems

Gamma completa per:

- Profili in alluminio con ossidazione naturale in barre o tagliati a misura
 - Accessori adatti alla realizzazione di strutture modulari (passare a pag.137 per la descrizione degli accessori)
- Refer to page no.137 for aluminium profiles accessories



SERIE
40

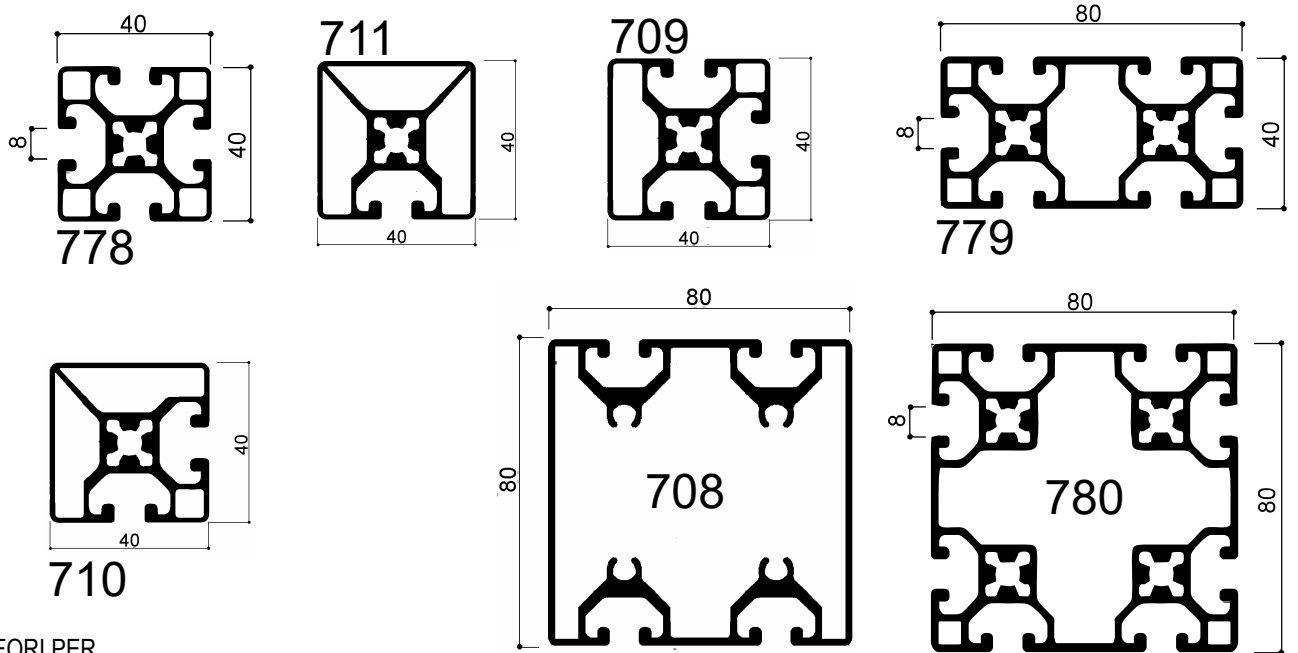

DISEGNI META' DEL VERO (1:2)- SCALE 1:2

FORI PER
FILETTO M8

Profili componibili per banchi e linee modulari

Profili strutturali - Extruded aluminium sections for modular systems

Gamma completa per:

- Profili in alluminio con ossidazione naturale in barre o tagliati a misura
 - Accessori adatti alla realizzazione di strutture modulari (passare a pag.159 per la descrizione degli accessori)
- Refer to page no.159 for aluminium profiles accessories



SERIE
45 CAVA 8

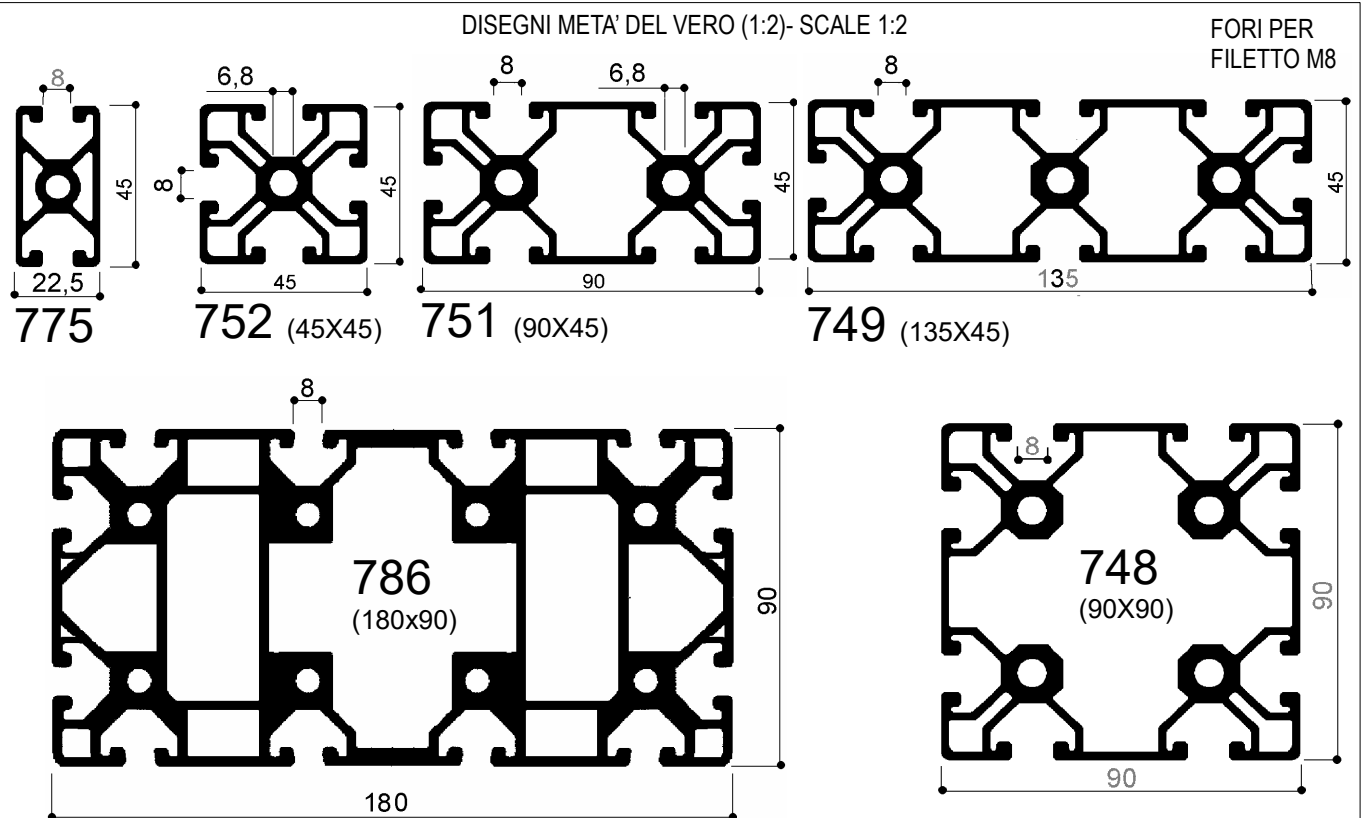

DISEGNI META' DEL VERO (1:2)- SCALE 1:2

FORI PER
FILETTO M8

Via Newton, n.12
20016 Pero (Milano - Italy)
Tel.+39 02 3535955 r.a. Fax.+39 02 3539929
E.Mail: info@omar-alluminio.it

Cataloghi Online: www.omar-alluminio.it
www.omar-alluminio.com

PROFILATI ALLUMINIO A DISEGNO / STANDARD / SPECIALI / E PER:
ELETTRONICA / LED / FOTOVOLTAICO / AUTOMAZIONE ROBOTICA / PNEUMATICA / AUTOMOTIVE

OMAR s.r.l.
PROFILATI ALLUMINIO
ALTA TECNOLOGIA

Profili componibili per banchi e linee modulari

Profili strutturali - Extruded aluminium sections for modular systems

Gamma completa per:

- Profili in alluminio con ossidazione naturale in barre o tagliati a misura
 - Accessori adatti alla realizzazione di strutture modulari
- (passare a pag.137 per la descrizione degli accessori)



SERIE
45 CAVA10 LEGGERO

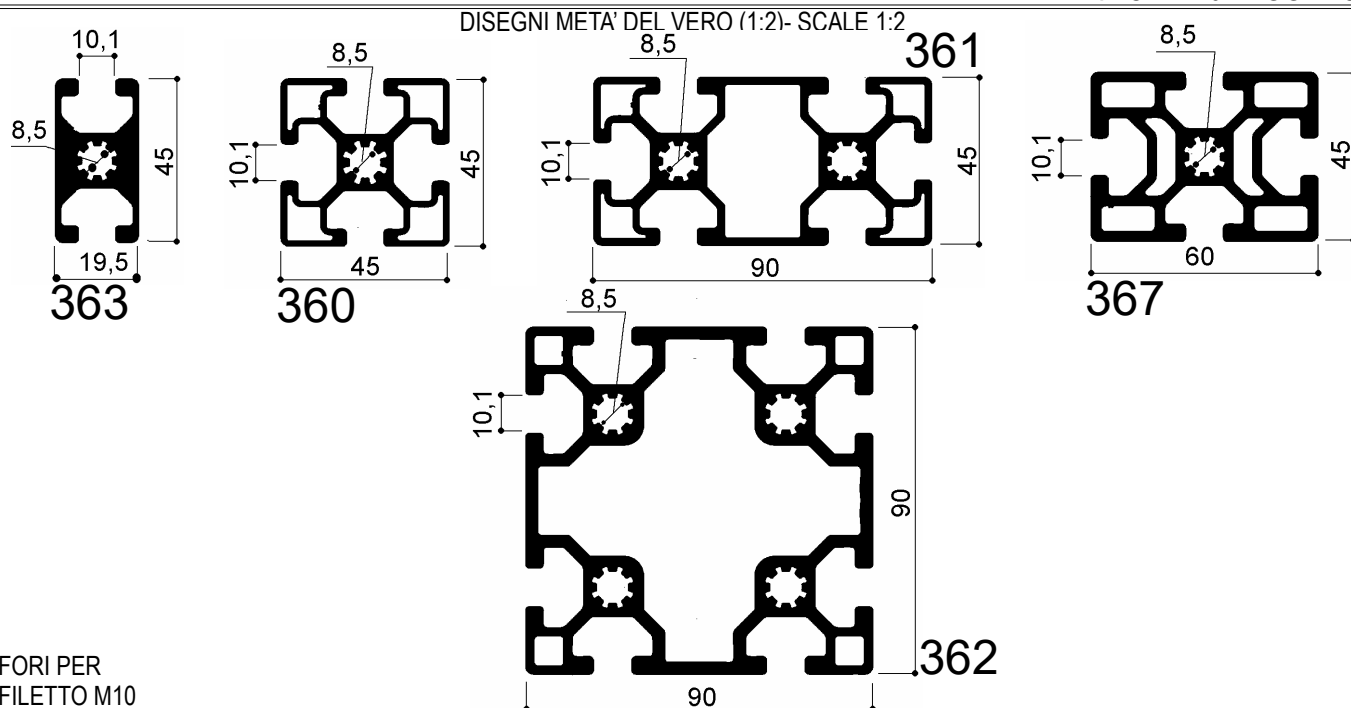

Via Newton, n.12
20016 Pero (Milano - Italy)
Tel. +39 02 3535955 r.a. Fax. +39 02 3539929
E-Mail: info@omar-alluminio.it

Profili componibili per banchi e linee modulari

Profili strutturali - Extruded aluminium sections for modular systems

Gamma completa per:

- Profili in alluminio con ossidazione naturale in barre o tagliati a misura
 - Accessori adatti alla realizzazione di strutture modulari
- (passare a pag.139 per la descrizione degli accessori)



SERIE
45 CAVA10 PESANTE

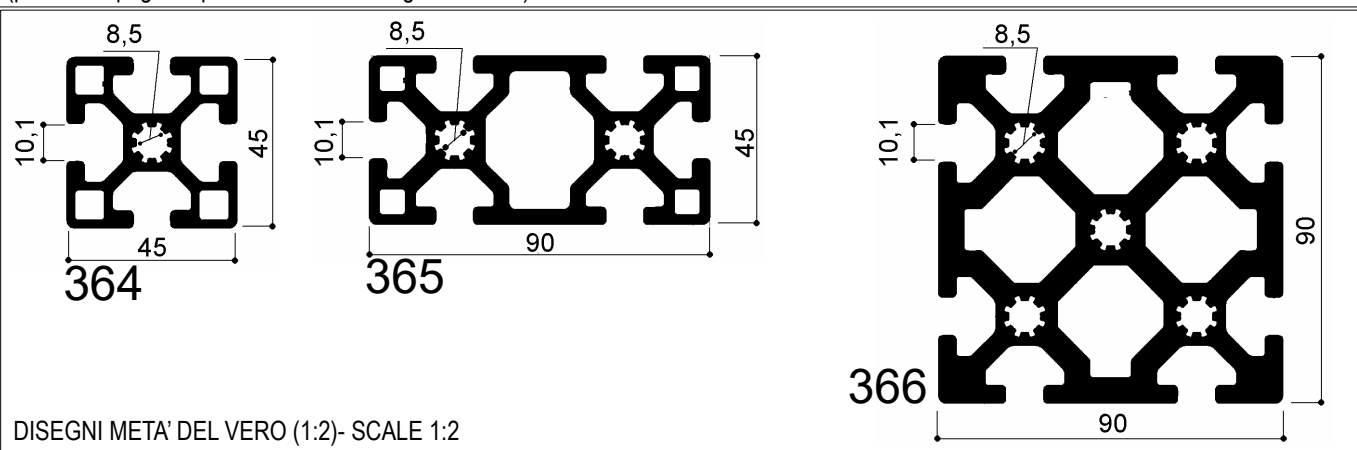

Cataloghi Online: www.omar-alluminio.it

www.omar-alluminio.com

PROFILATI ALLUMINIO A DISEGNO / STANDARD / SPECIALI / E PER:

ELETTRONICA / LED / FOTOVOLTAICO / AUTOMAZIONE ROBOTICA / PNEUMATICA / AUTOMOTIVE

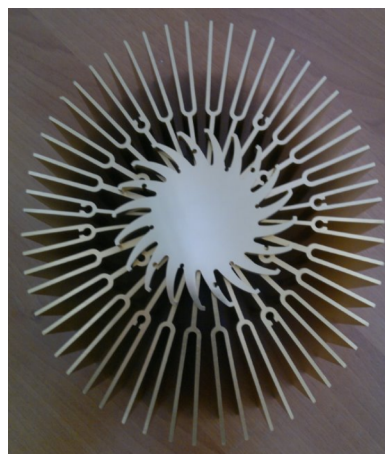
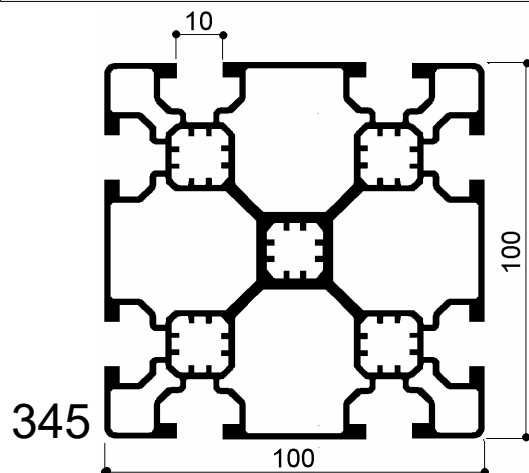

Profili componibili per banchi e linee modulari

Profili strutturali - Extruded aluminium sections for modular systems

Gamma completa per:

-Profili in alluminio con ossidazione naturale in barre o tagliati a misura

-Accessori adatti alla realizzazione di strutture modulari

(passare a pag.137 per la descrizione degli accessori)



SERIE
VARIE

DISEGNI AL VERO (1:1)- SCALE 1:1

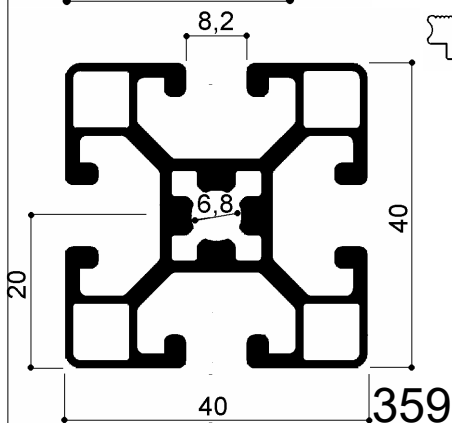
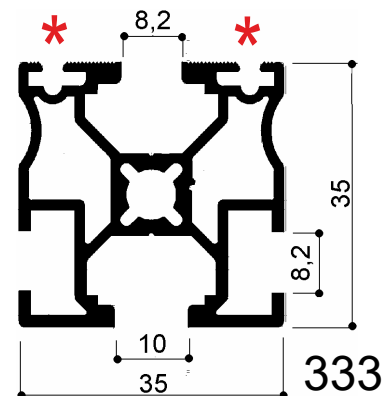
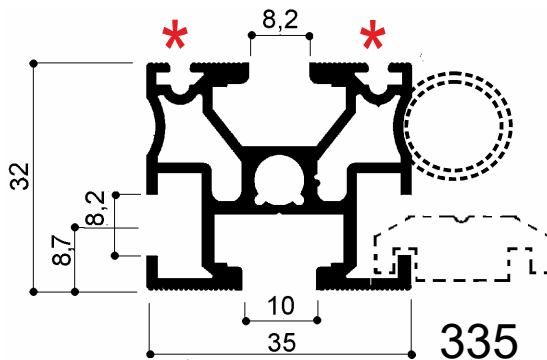
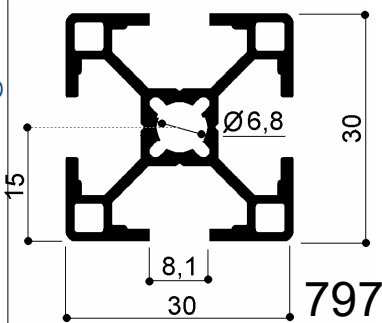

* CAVA PER L'EVENTUALE APPLICAZIONE DELLA GUARNIZIONE COD. EPDM712

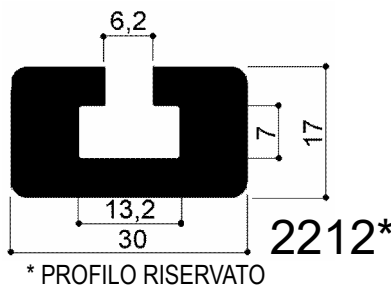

* PROFILO RISERVATO

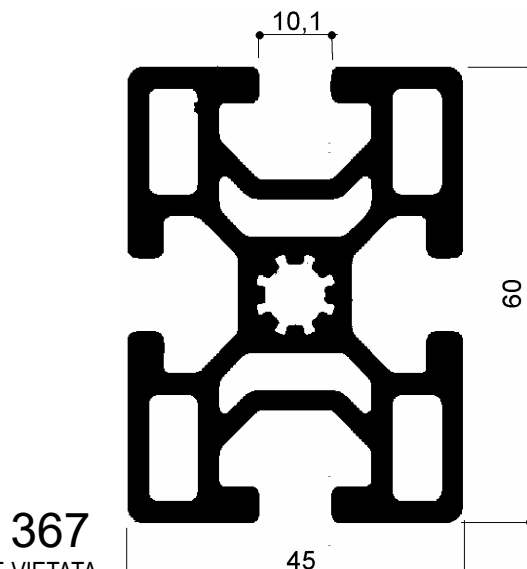
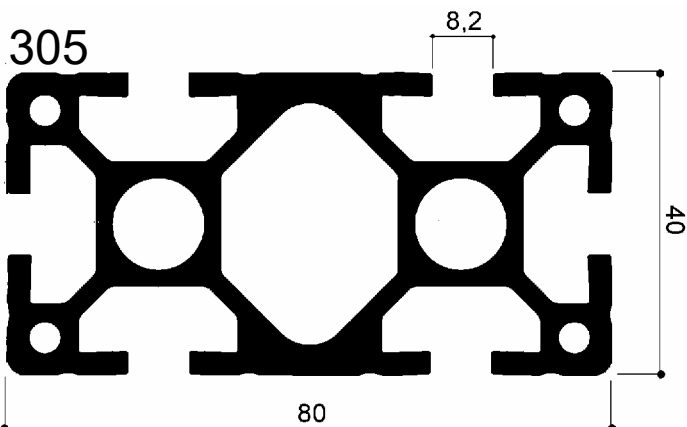
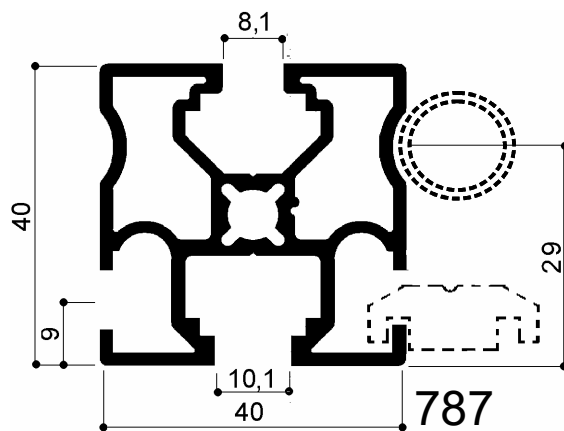
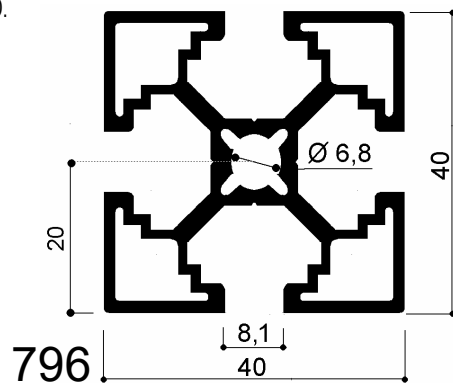

Profili componibili per banchi e linee modulari

Profili strutturali - Caratteristiche statiche

I_x = Momento d'inerzia su asse X

I_y = Momento d'inerzia su asse Y

W_x = Momento di resistenza su asse X

W_y = Momento di resistenza su asse Y

I DATI RIPORTATI SONO PURAMENTE INDICATIVI

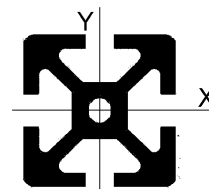

ART.	J_x (cm ⁴)	J_y (cm ⁴)	W_x (cm ³)	W_y (cm ³)	P(g/mt)
360	10,85	10,85	4,82	4,82	1544
361	22,55	86,87	10,02	19,29	2884
362	190,04	190,04	42,22	42,22	5557
363	6,42	3,11	2,85	2,76	1285
364	14,90	14,90	6,92	6,62	2020
365	33,83	120,79	14,58	26,83	4093
366	284,26	284,26	63,16	63,16	9717
367	21,46	35,79	9,53	11,92	2835
708	105,258	91,229	26,305	22,799	3375
709	8,096	7,795	4,048	3,736	1369
710	7,852	7,855	3,849	3,852	1326
711	7,841	7,601	3,891	3,800	1283
726	98,219	26,011	24,555	13,006	4207
727	14,002	14,002	7,001	7,001	2376
729	175,68	175,68	43,92	43,92	6539
730	9,913	9,913	4,957	4,957	1790
731	9,878	9,878	4,921	4,921	1709
732	72,237	18,458	18,059	9,229	3032
733	124,759	124,759	31,19	31,19	4574
734	503,196	35,546	62,899	17,722	5516
735	0,68	0,68	0,68	0,68	459
736	0,64	0,71	0,64	0,68	481
737	0,69	0,69	0,69	0,69	459
739	9,786	10,005	4,888	4,979	1749
740	6,41	6,41	2,777	2,777	1401
741	1147,892	335,465	143,483	83,868	12290
742	311,220	38,96	51,897	19,481	6032
743	529,588	253,727	85,922	63,417	9642
747	27,002	224,416	13,501	37,403	4277
748	148,255	148,255	32,946	32,946	4112
749	276,197	32,675	40,918	14,522	3969
750	6,809	6,808	3,044	3,052	1463
751	22,472	90,373	9,968	20,082	2878
752	12,4	12,4	5,511	5,511	1787
753	3022,650	1208,716	302,264	201,453	20260
755	2,85	2,85	1,9	1,9	872
756	4,994	20,149	3,329	6,716	1490
757	35,400	35,400	11,800	11,800	2680
759	19,493	75,379	9,525	18,63	3140
760	8,596	42,024	5,731	12,007	2376
769	2,929	2,741	1,942	1,827	867
770	2,883	2,882	1,904	1,902	853
771	2,811	3,05	1,823	2,033	891
775	6,519	2,292	2,897	2,197	1800
776	269,634	899,676	67,399	112,46	9731
777	205,015	422,99	51,248	68,556	7825
778	7,132	7,132	3,564	3,564	1318
779	15,151	59,684	7,576	14,921	2432
780	103,553	103,553	25,888	25,888	3846
784	2,177	2,175	1,341	1,338	778
785	3,002	2,634	2	1,756	861
786	1444,094	395,108	160,438	87,793	12050

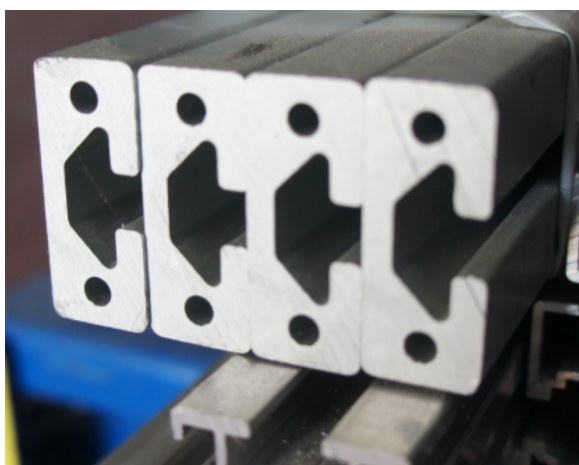
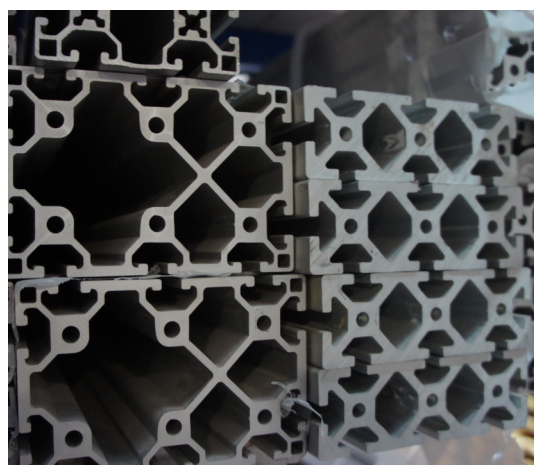

Via Newton, n.12
20016 Pero (Milano - Italy)
Tel. +39 02 3535955 r.a. Fax. +39 02 3539929
E-Mail: info@omar-alluminio.it

Cataloghi Online: www.omar-alluminio.it
www.omar-alluminio.com

PROFILATI ALLUMINIO A DISEGNO / STANDARD / SPECIALI / E PER:
ELETTRONICA / LED / FOTOVOLTAICO / AUTOMAZIONE ROBOTICA / PNEUMATICA / AUTOMOTIVE



Profili componibili per banchi e linee modulari



Profili strutturali - Extruded aluminium sections for modular systems

Gamma completa per:

- Profili in alluminio con ossidazione naturale in barre o tagliati a misura
- Accessori adatti alla realizzazione di strutture modulari (passare a pag.137 per la descrizione degli accessori)

Via Newton, n.12
20016 Pero (Milano - Italy)
Tel. +39 02 3535955 r.a. Fax. +39 02 3539929
E-Mail: info@omar-alluminio.it

Cataloghi Online: www.omar-alluminio.it
www.omar-alluminio.com

PROFILATI ALLUMINIO A DISEGNO / STANDARD / SPECIALI / E PER:
ELETTRONICA / LED / FOTOVOLTAICO / AUTOMAZIONE ROBOTICA / PNEUMATICA / AUTOMOTIVE

DISEGNI META' DEL VERO

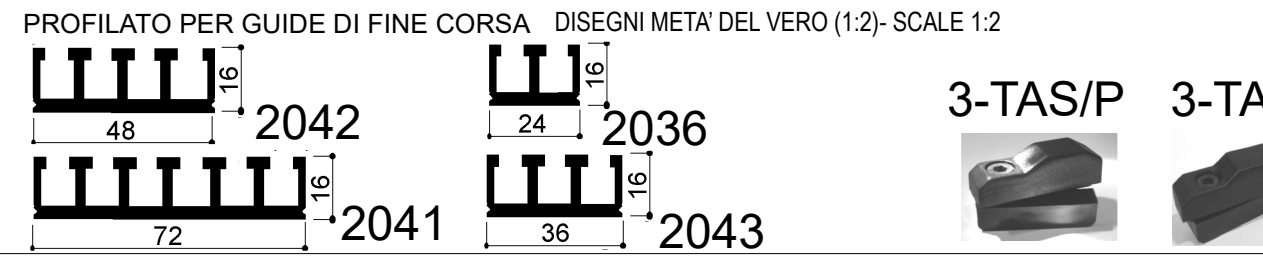
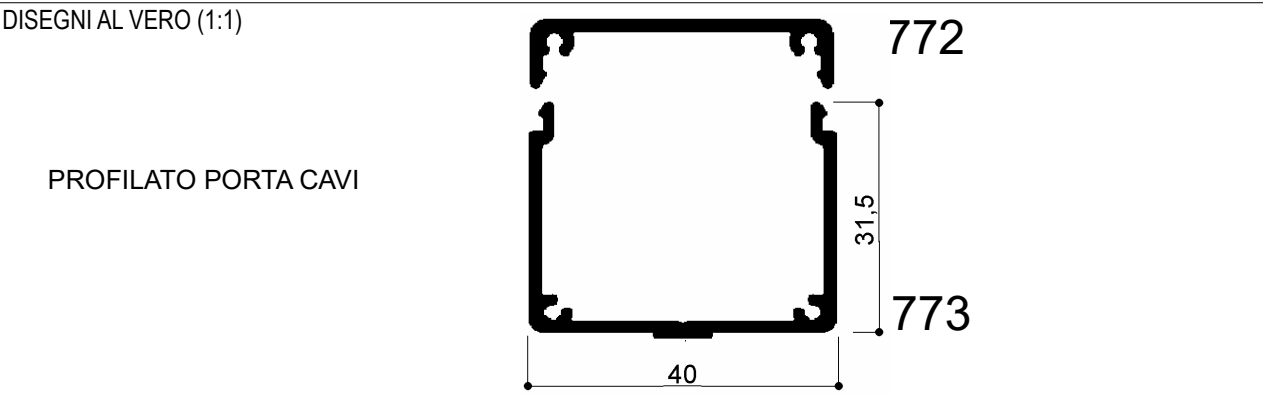
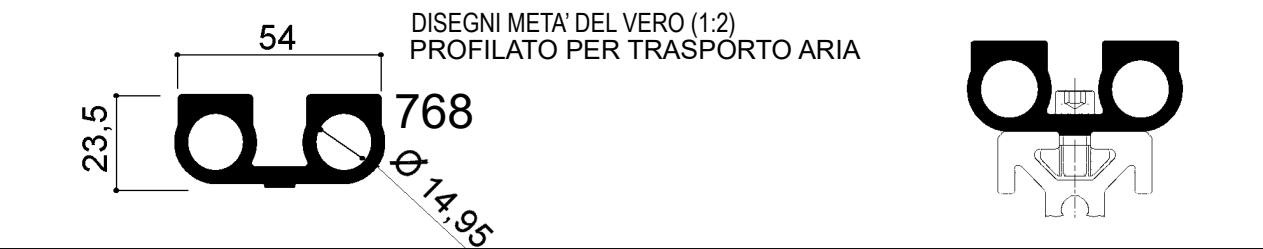
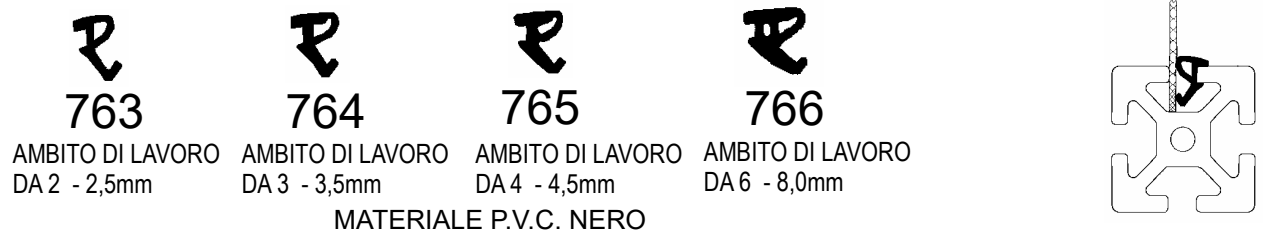
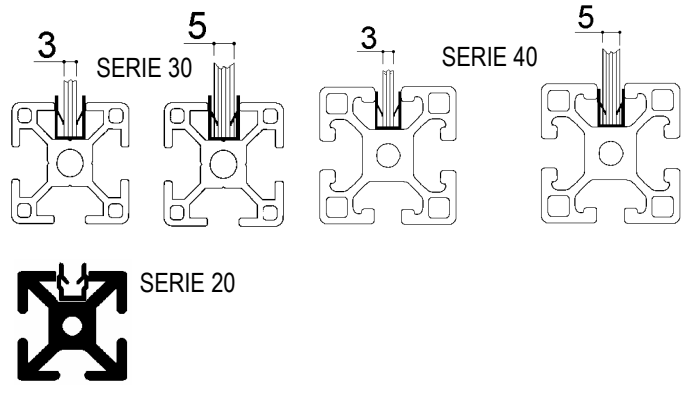
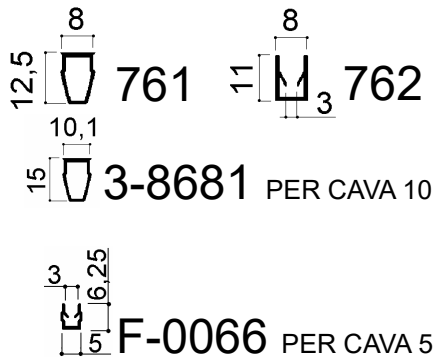

Profili componibili modulari in alluminio

Extruded aluminium profiles for modular systems

-Profili in alluminio ossidati naturale fornibili in barre o tagliati a misura

-ACCESSORI vedi pag. 147



DISEGNI AL VERO (1:1)

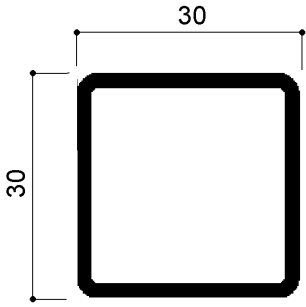
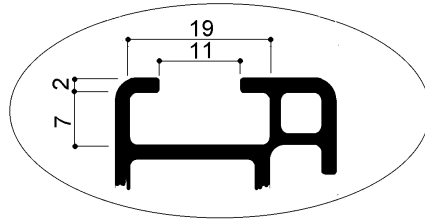

720

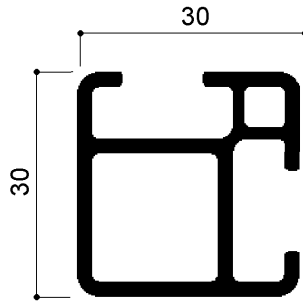

724

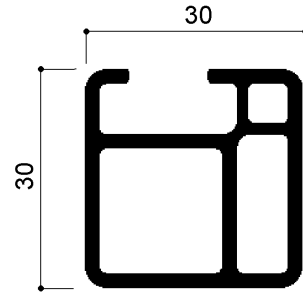

725

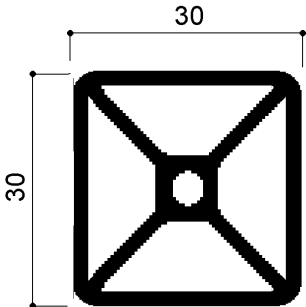

FORO PER FILETTO M5

721

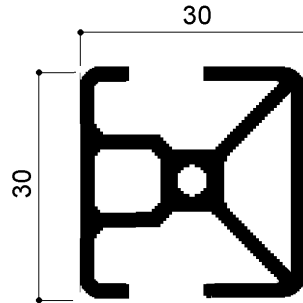

FORO PER FILETTO M5

723

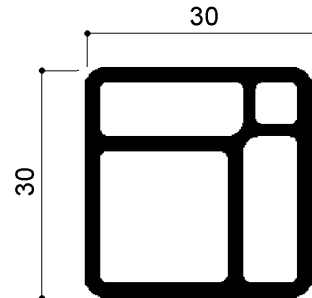

722

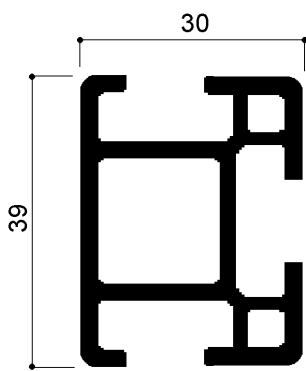

719

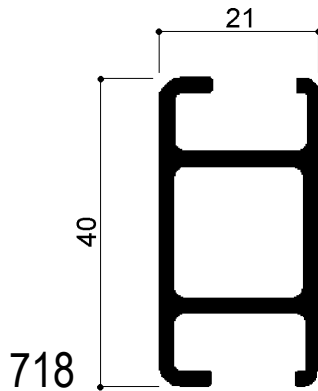

718

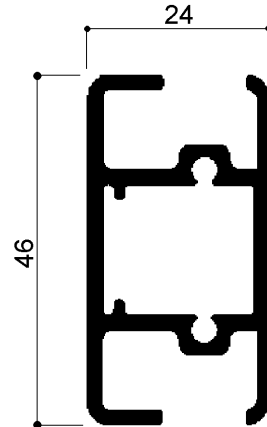

717

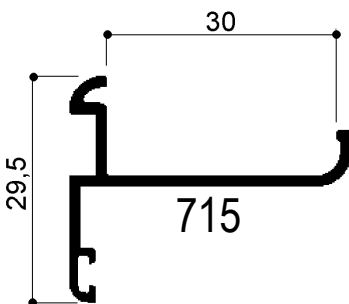

715

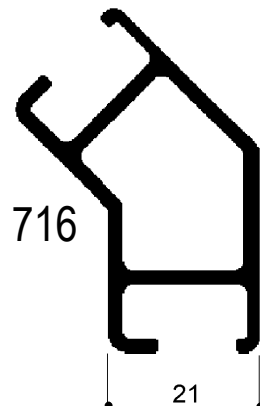

716

Via Newton, n.12

20016 Pero (Milano - Italy)

Tel. +39 02 3535955 r.a. Fax. +39 02 3539929

E-Mail: info@omar-alluminio.it

Cataloghi Online: www.omar-alluminio.it

www.omar-alluminio.com

PROFILATI ALLUMINIO A DISEGNO / STANDARD / SPECIALI / E PER:

ELETTRONICA / LED / FOTOVOLTAICO / AUTOMAZIONE ROBOTICA / PNEUMATICA / AUTOMOTIVE



Profilati in alluminio strutturali / Travi / Longheroni

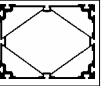

DISEGNI META' DEL VERO (1:2)

Cataloghi Online: www.omar-alluminio.it

www.omar-alluminio.com

PROFILATI ALLUMINIO A DISEGNO / STANDARD / SPECIALI / E PER:

ELETRONICA / LED / FOTOVOLTAICO / AUTOMAZIONE ROBOTICA / PNEUMATICA / AUTOMOTIVE

Via Newton, n.12

20016 Pero (Milano - Italy)

Tel. +39 02 3535955 r.a. Fax. +39 02 3539929

E-Mail: info@omar-alluminio.it

OMAR s.r.l.
PROFILATI ALLUMINIO
ALTA TECNOLOGIA

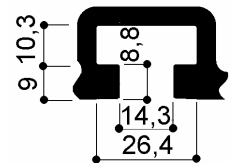
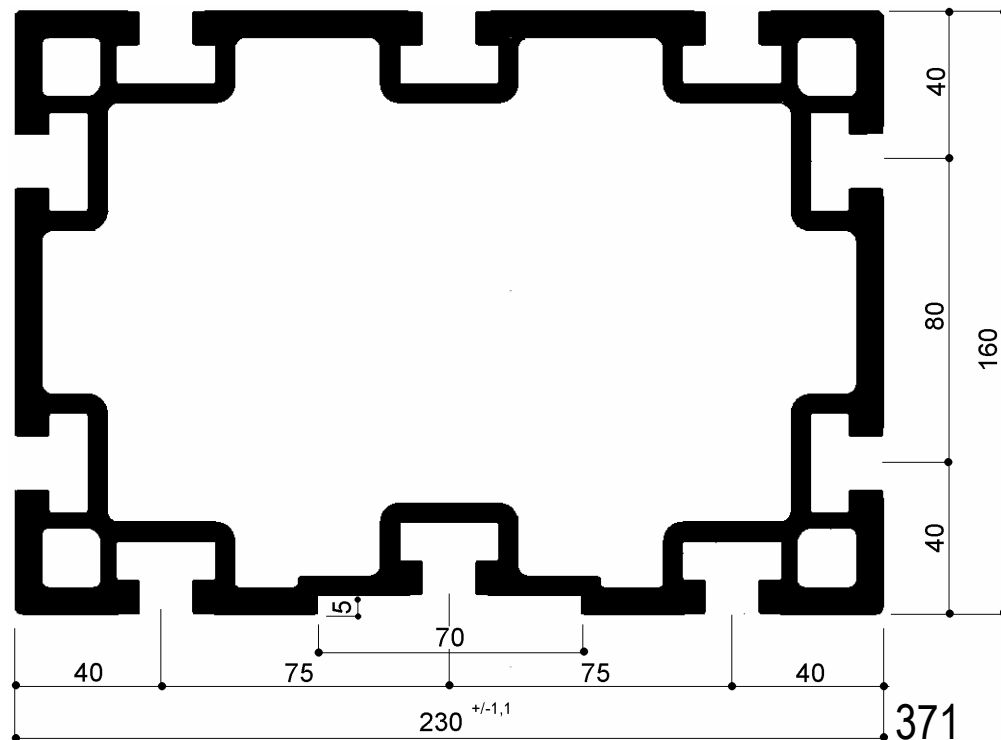
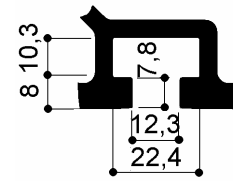
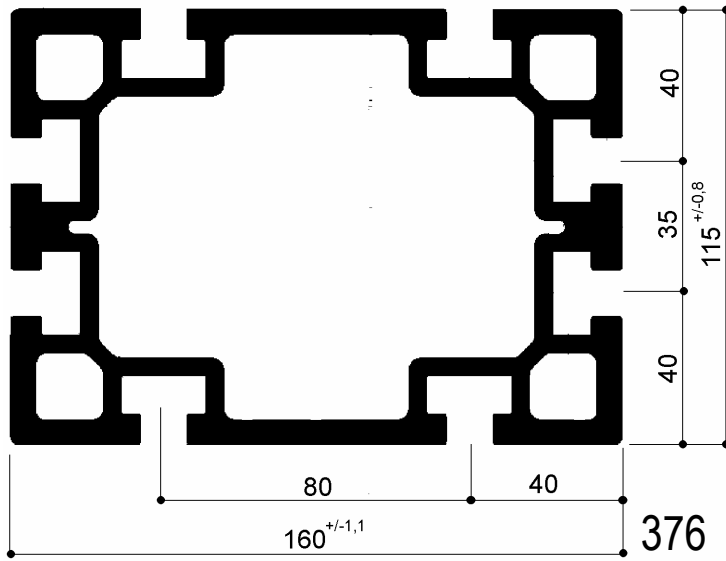
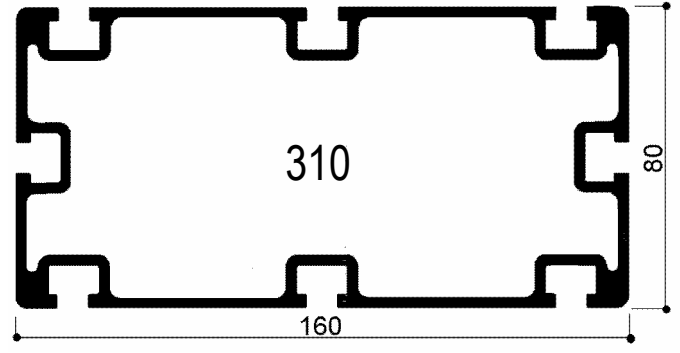
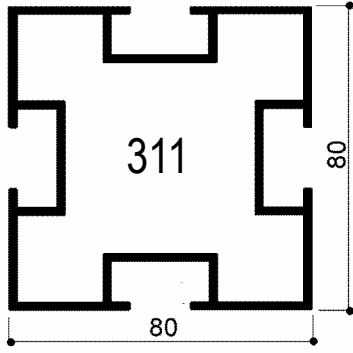

Profilati in alluminio strutturali / Travi / Longheroni

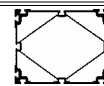

DISEGNI META' DEL VERO (1:2)

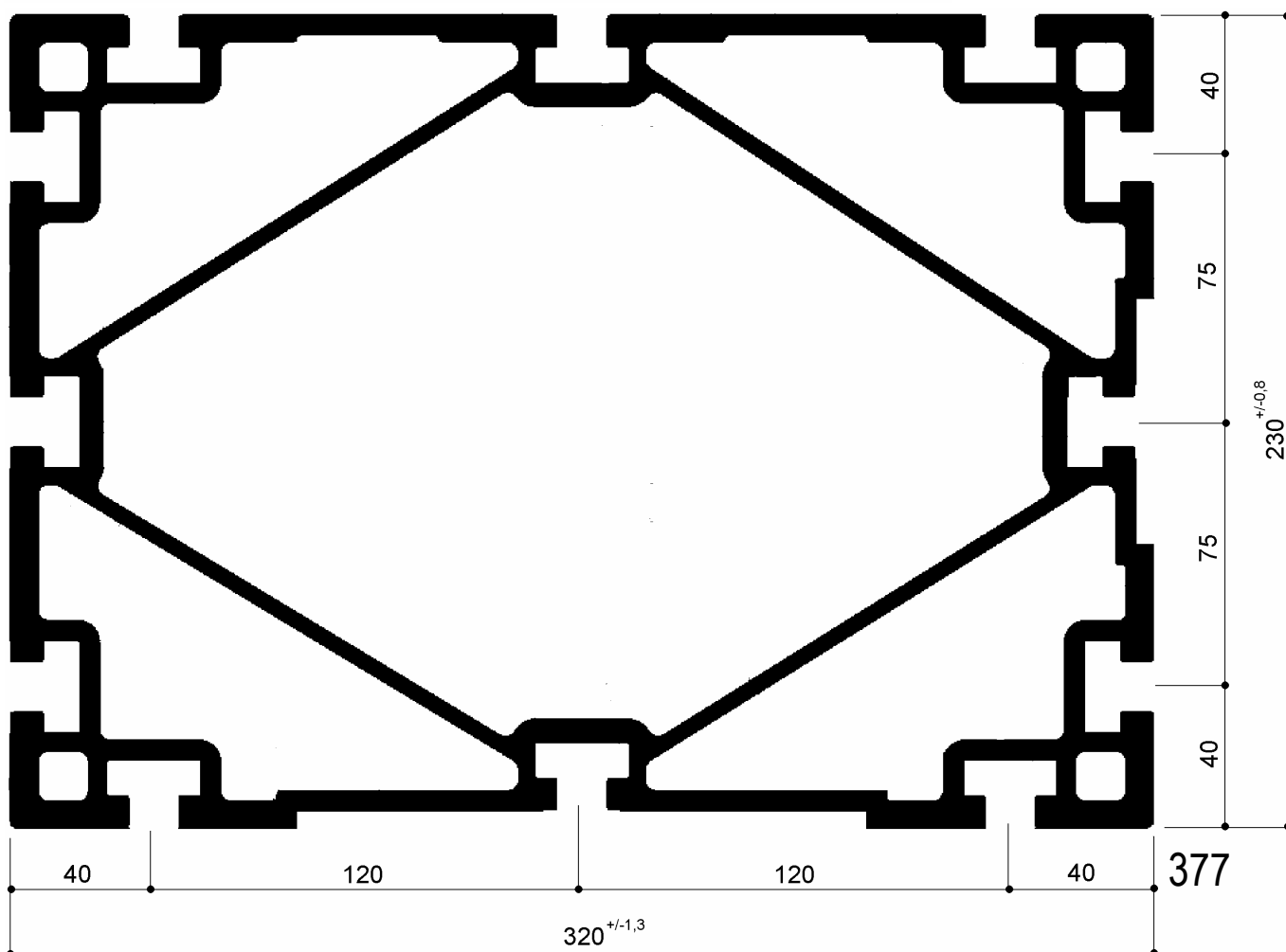
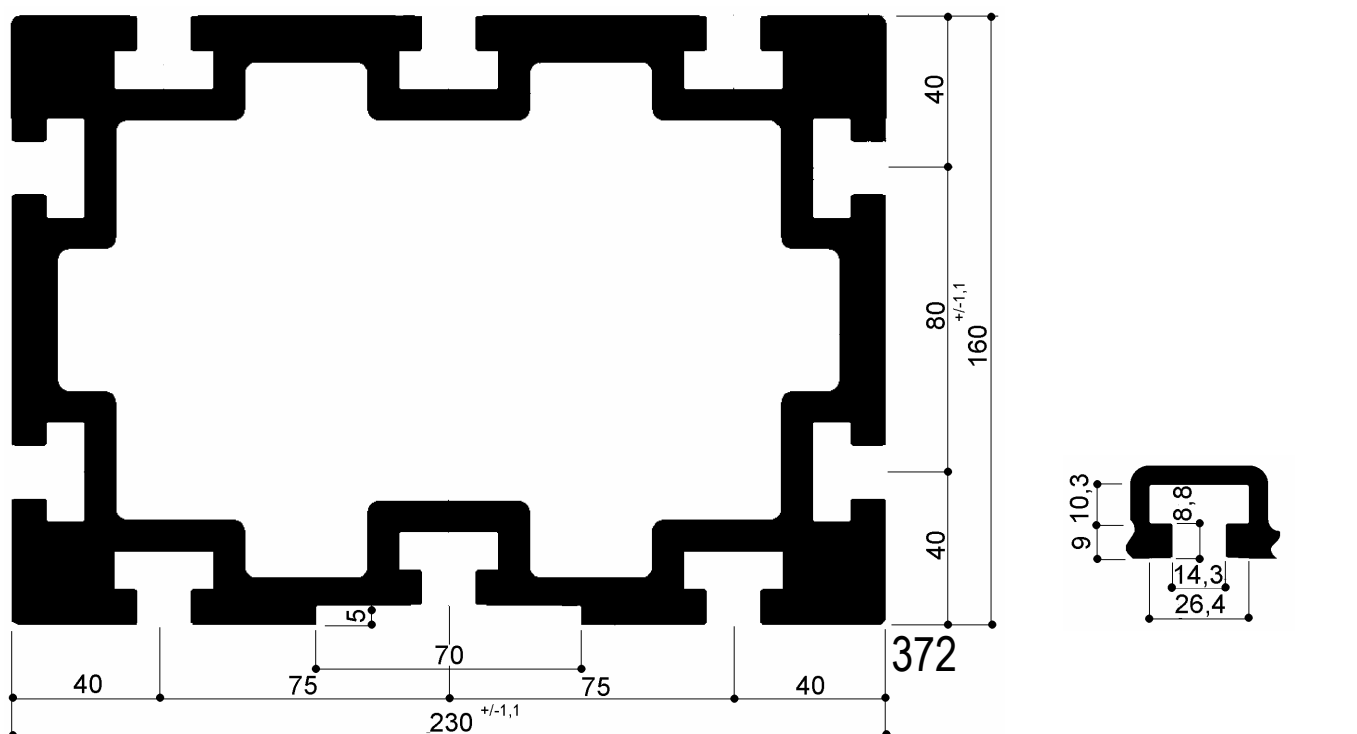

Via Newton, n.12
20016 Pero (Milano - Italy)
Tel. +39 02 3535955 r.a. Fax. +39 02 3539929
E-Mail: info@omar-alluminio.it

Cataloghi Online: www.omar-alluminio.it
www.omar-alluminio.com

PROFILATI ALLUMINIO A DISEGNO / STANDARD / SPECIALI / E PER:
ELETTRONICA / LED / FOTOVOLTAICO / AUTOMAZIONE ROBOTICA / PNEUMATICA / AUTOMOTIVE



Profilati in alluminio strutturali / Travi / Longheroni

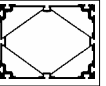

DISEGNI META' DEL VERO (1:2)

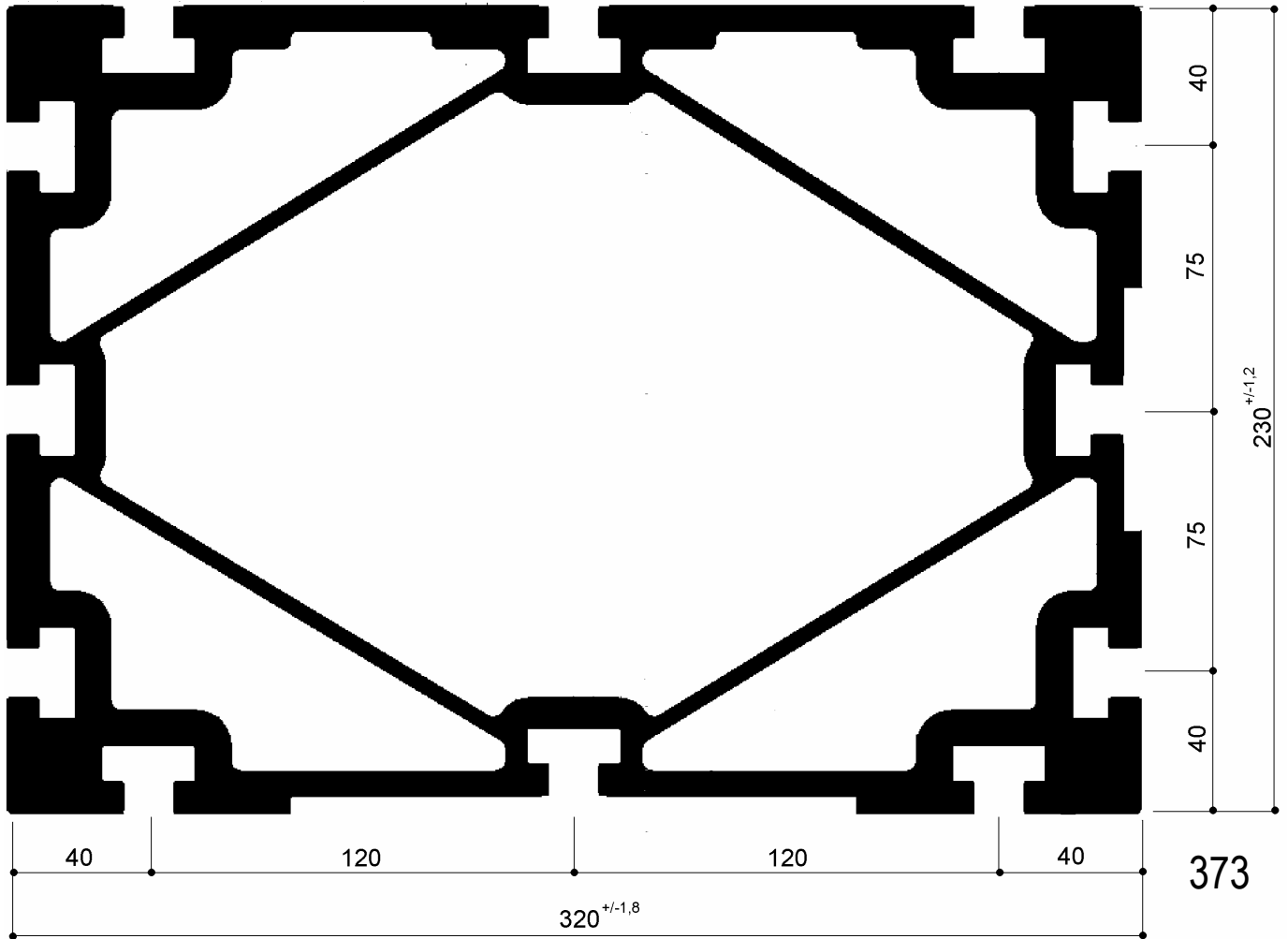

E' possibile fornire barre in lunghezza MASSIMA di 10 mt.

FOTO DI ESEMPIO: UNA DELLE TRE LINEE DI TAGLIO A MISURA DI PROFILI IN ALLUMINIO ESTRUSO

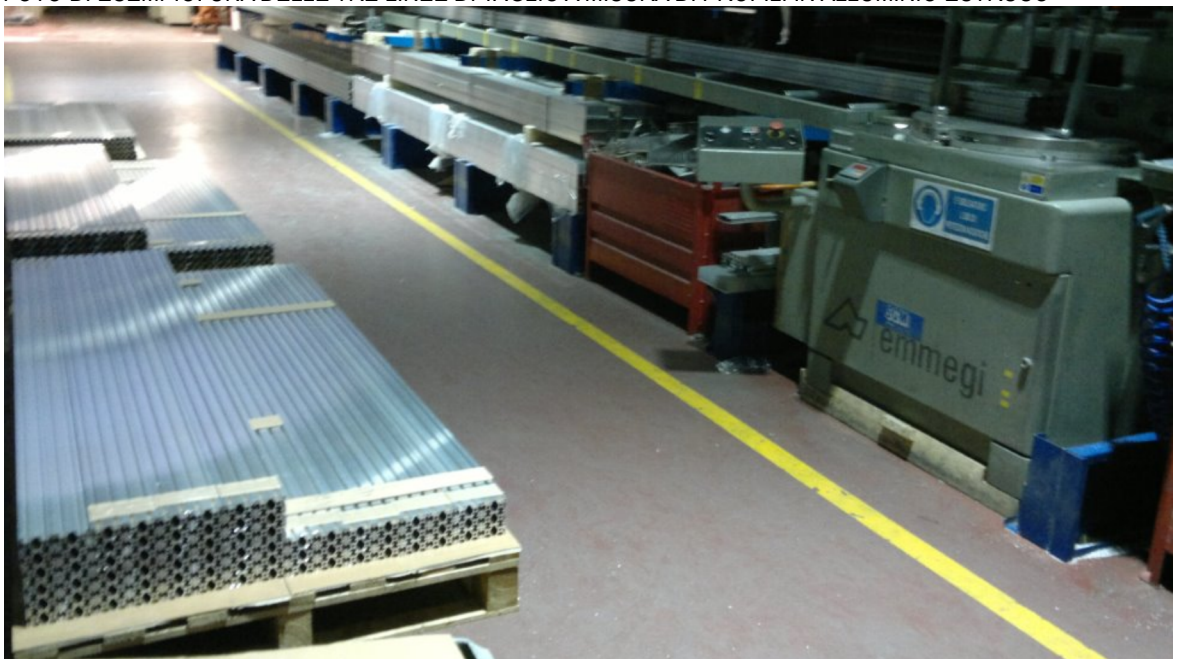

E' possibile fornire barre in lunghezza MASSIMA di 10 mt.

AGGIORNAMENTO CONTINUO - ED. DEL 06-2021-RIPRODUZIONE VIETATA-

Cataloghi Online: www.omar-alluminio.it
www.omar-alluminio.com

Via Newton, n.12

20016 Pero (Milano - Italy)

Tel. +39 02 3535955 r.a. Fax. +39 02 3539929

E-Mail: info@omar-alluminio.it

PROFILATI ALLUMINIO A DISEGNO / STANDARD / SPECIALI / E PER:

ELETTRONICA / LED / FOTOVOLTAICO / AUTOMAZIONE ROBOTICA / PNEUMATICA / AUTOMOTIVE

OMAR s.r.l.
PROFILATI ALLUMINIO
ALTA TECNOLOGIA

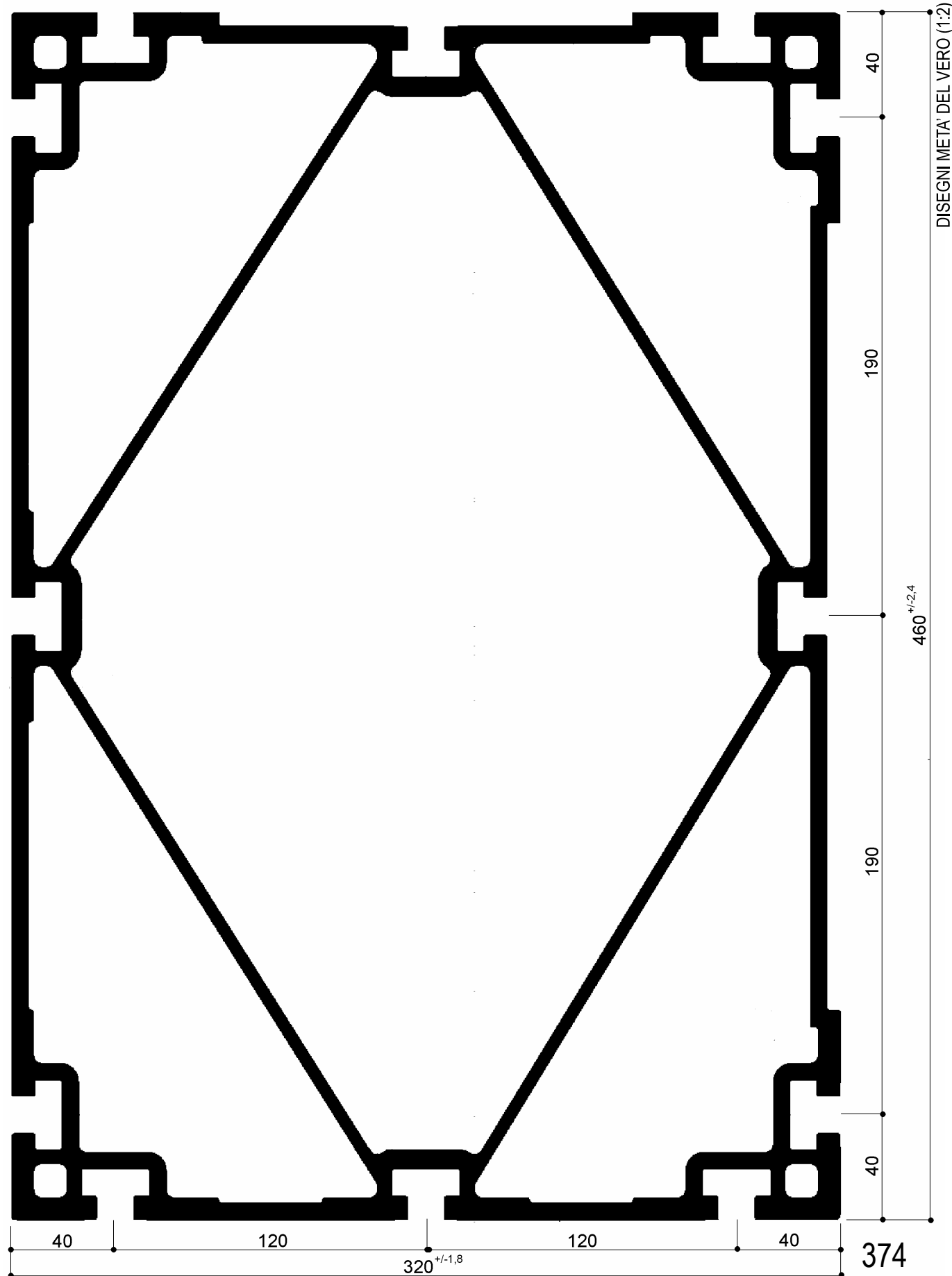
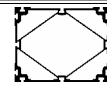

DISEGNI METÀ DEL VERO (1:2)

Cataloghi Online: www.omar-alluminio.it

www.omar-alluminio.com

PROFILATI ALLUMINIO A DISEGNO / STANDARD / SPECIALI / E PER:

ELETTRONICA / LED / FOTOVOLTAICO / AUTOMAZIONE ROBOTICA / PNEUMATICA / AUTOMOTIVE

Via Newton, n.12

20016 Pero (Milano - Italy)

Tel. +39 02 3535955 r.a. Fax. +39 02 3539929

E-Mail: info@omar-alluminio.it



Profilati in alluminio strutturali / Travi / Longheroni

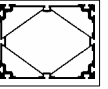

Cataloghi Online: www.omar-alluminio.it
www.omar-alluminio.com

Via Newton, n.12
 20016 Pero (Milano - Italy)
 Tel. +39 02 3535955 r.a. Fax. +39 02 3539929
 E-Mail: info@omar-alluminio.it

PROFILATI ALLUMINIO A DISEGNO / STANDARD / SPECIALI / E PER:
 ELETTRONICA / LED / FOTOVOLTAICO / AUTOMAZIONE ROBOTICA / PNEUMATICA / AUTOMOTIVE

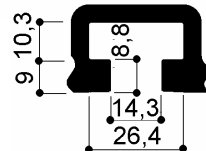
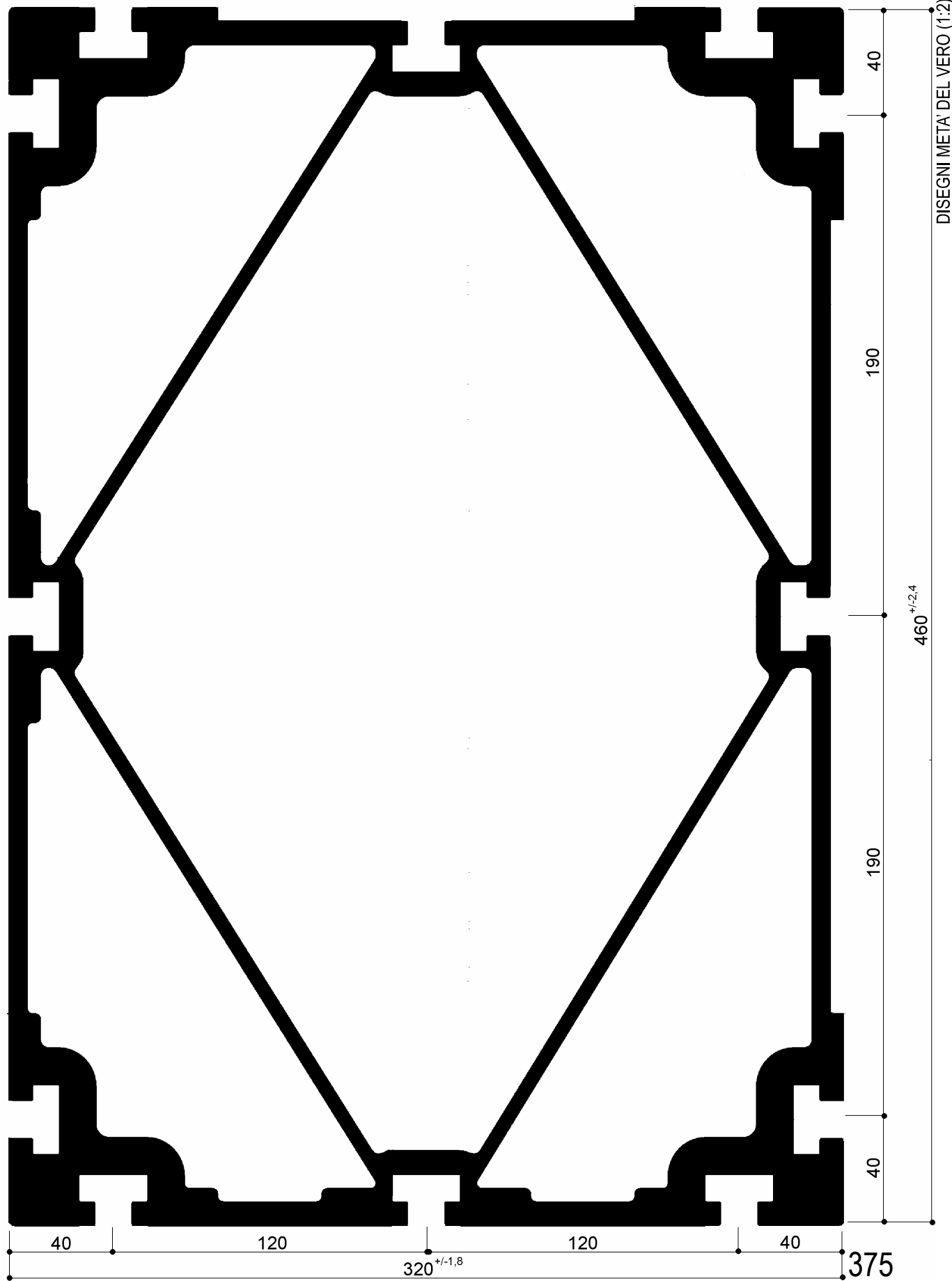

E' possibile fornire barre in lunghezza MASSIMA di 10 mt.
 AGGIORNAMENTO CONTINUO - ED. DEL 06-2021

-RIPRODUZIONE VIETATA-

ACCESSORI per profili componibili, banchi e linee modulari - Profili strutturali -



Gamma completa per:

-Profili in alluminio con ossidazione naturale in barre o tagliati a misura

-Accessori adatti alla realizzazione di strutture modulari (passare a pag.71 per i disegni dei profili)

Serie 40

Squadrette 90°

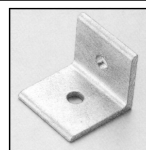

Squadretta in alluminio 40x40x40 anodizzato argento
Utilizzabile con art.726 727 728 729 730 731 732 733 734 740
741 742 743 744 747
Codice Art.: 3-5431/A

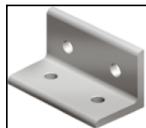

Squadretta in alluminio 40x40x80.
Utilizzabile con art.726 727 728 729 730 731 732 733 734 740
741 742 743 744 747
Codice Art.: F-0074



Squadretta in alluminio 60x60x40.
Utilizzabile con art.726 727 728 729 730 731 732 733 734 740
741 742 743 744 747
Codice Art.: 3-6431

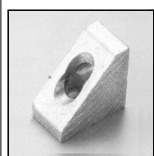
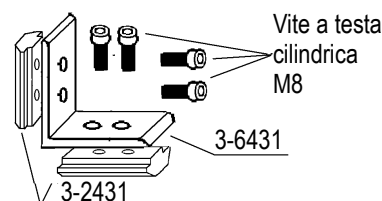
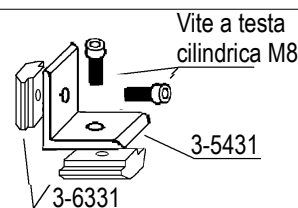

Squadretta in alluminio 40x40x20.
Utilizzabile con art.726 727 728 729 730 731 732 733 734 740
741 742 743 744 747
Codice Art.: 3-7431

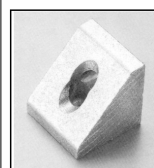

Squadretta in alluminio 40x40x40.
Utilizzabile con art.726 727 728 729 730 731 732 733 734 740
741 742 743 744 747
Codice Art.: 3-8431

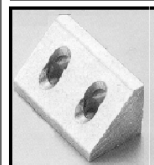

Squadretta in alluminio 40x40x80.
Utilizzabile con art.726 727 728 729 730 731 732 733 734 740
741 742 743 744 747
Codice Art.: 3-9431

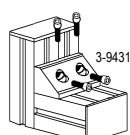
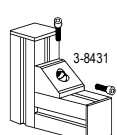
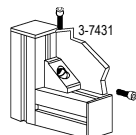
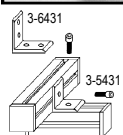

Esempio di utilizzo degli articoli sopra riportati

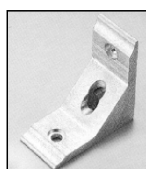
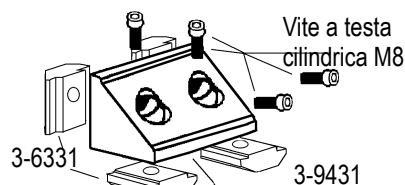
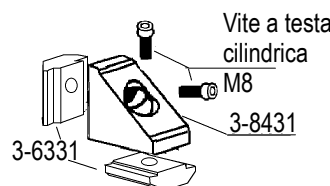
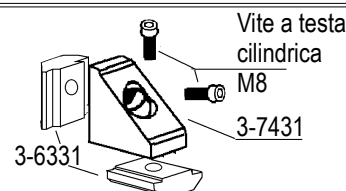

Squadretta in alluminio 80x80x40.
Utilizzabile con art.726 727 728 729 730 731 732 733 734 740
741 742 743 744 747
Codice Art.: 3-0531



Squadretta in alluminio 80x80x80.
Utilizzabile con art.728 729 732 733 734 740
741 742 743 744 747
Codice Art.: 3-1531

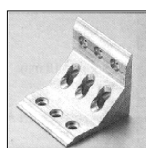

Squadretta in alluminio 80x80x120.
Utilizzabile con art.734 747 749 741 743 742
Codice Art.: 3-2241

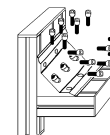
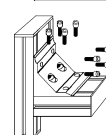
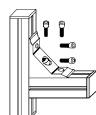
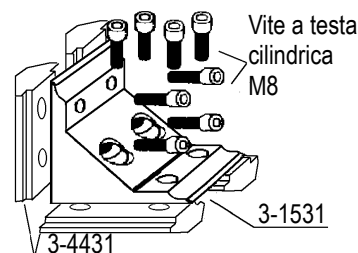
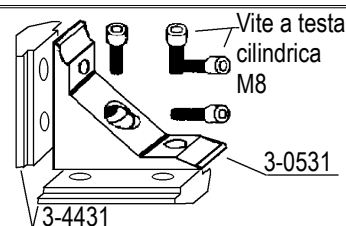

Esempio di utilizzo degli articoli sopra riportati

ACCESSORI per profili componibili, banchi e linee modulari - Profili strutturali



Gamma completa per:

-Profili in alluminio con ossidazione naturale in barre o tagliati a misura

-Accessori adatti alla realizzazione di strutture modulari (passare a pag.71 per i disegni dei profili)

Serie 40

Via Newton, n.12
20016 Pero (Milano - Italy)
Tel. +39 02 3535955 r.a. Fax. +39 02 3539929
E.Mail: info@omar-alluminio.it

Cataloghi Online: www.omar-alluminio.it
www.omar-alluminio.com

PROFILATI ALLUMINIO A DISEGNO / STANDARD / SPECIALI / E PER:
ELETTRONICA / LED / FOTOVOLTAICO / AUTOMAZIONE ROBOTICA / PNEUMATICA / AUTOMOTIVE

Piastra in alluminio
Codice Art. F-0078 40x80 per giunzione a 90°
Codice Art. F-0082 80x80 per collegamento



Esempio utilizzo F-0082

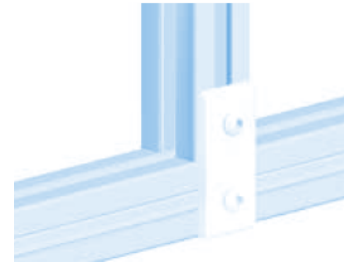

Esempio utilizzo F-0078

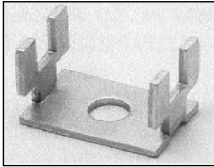

Piastrina in alluminio anti-rotazione per collegamenti 90

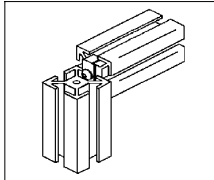

Codice Art.: 3-3241

Foro passante
diametro 7
per chiave
esagonare

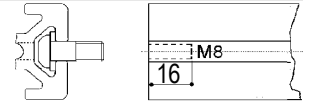

3-3241
Vite testa
cilindrica
M8

22,5

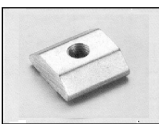

Cursore alluminio lunghezza 18mm
con 1 foro M6 Codice Art.3-5331
con 1 foro M8 Codice Art 3-6331
con 1 foro M4 Codice Art 3-0341

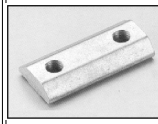

Cursore alluminio lunghezza 40mm con
2 fori M6 interasse 20 mm - Codice Art.3-9331
Cursore alluminio lunghezza 40mm con
2 fori M8 interasse 25 mm Codice Art.3-2431

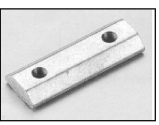

Cursore alluminio lunghezza 50mm con
2 fori M6 interasse 30 mm Codice Art.3-0431
Cursore alluminio lunghezza 50mm con
2 fori M8 interasse 30 mm Codice Art.3-3431

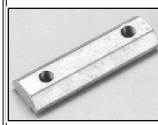

Cursore alluminio lunghezza 60mm con
2 fori M6 interasse 40 mm Codice Art.3-1431
Cursore alluminio lunghezza 60mm con
2 fori M8 interasse 40 mm Codice Art.3-4431

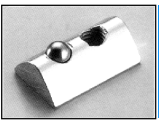

Cursore in acciaio zincato a 'culla' per
montaggio frontale da 22 mm con sferetta
Codice Art.3-1731 M8
Codice Art.3-0731 M6

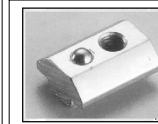

Cursore in acciaio zincato da 22 mm con sferetta
Codice Art.3-2731 M6
Cursore in acciaio zincato da 22 mm con sferetta
Codice Art.3-3731 M8

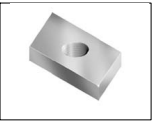

Piastra romboidale filettata m8
in acciaio zincato misure 23x15x6
Codice Art.F-0029

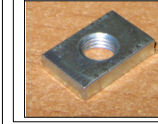

Piastrina in acciaio zincato 20x13
spessore 5 mm
M8 Cod Art.F-0030
M6 Cod Art.F-0044



Cursore a martello M8x25 in acciaio
zincato per montaggio frontale.
Codice Art.3-9341

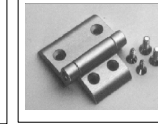

Cerniera alluminio con perno diametro
7 mm.
Codice Art.3-1141

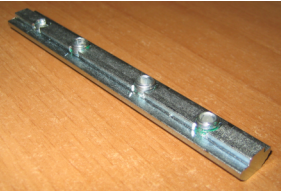

Prolunga profilo completa di grani
M8 a punta
Cod. Art.3-5341 versione in acciaio zincato
Cod. Art.4-0019 versione in alluminio Lega 6082

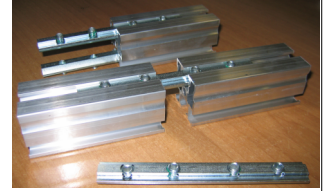
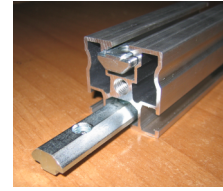

Ruota per porte scorrevoli
Cod. Art.F-0061



Collegamento 90° a scomparsa
in acciaio zincato per serie 40
Codice Art.F-0067

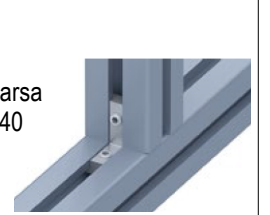

ACCESSORI per profili componibili, banchi e linee



modulari - Profili strutturali

Gamma completa per:

-Profili in alluminio con ossidazione naturale in barre o tagliati a misura

-Accessori adatti alla realizzazione di strutture modulari (passare a pag.71 per i disegni dei profili)

Serie 40

 <p>Piede regolabile per profili 40x40 Codice Art.F-0058</p>	 <p>Reggicavo (materiale plastico) Codice Art.F-0060</p>
 <p>Reggi cavo in materiale plastico a croce. Cod.Art.F-0010</p>	 <p>Reggi cavo in materiale plastico. Cod.Art.F-0009</p>
 <p>Reggi cavo in materiale plastico con due paratie. Cod.Art.F-0020</p>	 <p>Reggi cavo in materiale plastico doppio Cod.Art.F-0024</p>
 <p>Morsetto con cuscinetti in gomma per pannelli o vetri spessore da 2 a 10mm Cod. Art.: F-0014</p>	 <p>Giunzione 90° per porta pannello F-0014 Cod. Art.: F-0015</p>
 <p>Collegamenti in alluminio a 45° Codice Art.3-8931</p>  <p>Collegamenti in alluminio a 45° Codice Art.3-9931</p>	 <p>Giunto in metallo 40x40 con snodo e brugola di bloccaggio. Codice Art.: 3-7341</p>

Giunto 90°

Giunto in alluminio per collegamenti a 90° singolo (40x40) e doppio (40x80). Utilizzabile con Art.: 726 727 728 729 730 731 732 733 734 739 740 741 742 743 747

- Codice Art. 3-5241 (80x80)
- Codice Art. 3-7131 (40x40)
- Codice Art. 3-8041 (40x40) con scasso x tamponamento
- Codice Art. 3-6241 (40x80)
- Codice Art. 3-8131 (40x80)
- Codice Art. 3-6441 (60X60)

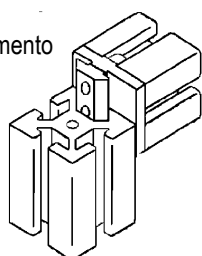

3-7131 (40x40)

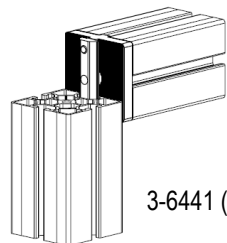

3-6441 (60X60)

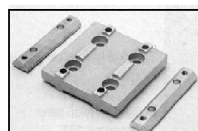

3-5241 (80x80)

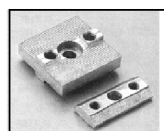

3-7131 (40x40)



3-8041 (40X40)



3-6441 (60X60)

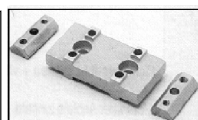

3-6241 (40x80)

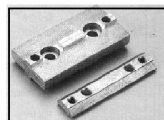

3-8131 (40x80)

ISTRUZIONI PER L'UTILIZZO

FASE A) Montare la vite M8x16 e le viti M6x22 sul giunto

FASE B) Avvitare la vite M8x16 sul profilo

FASE C) Collegare il secondo profilo al giunto

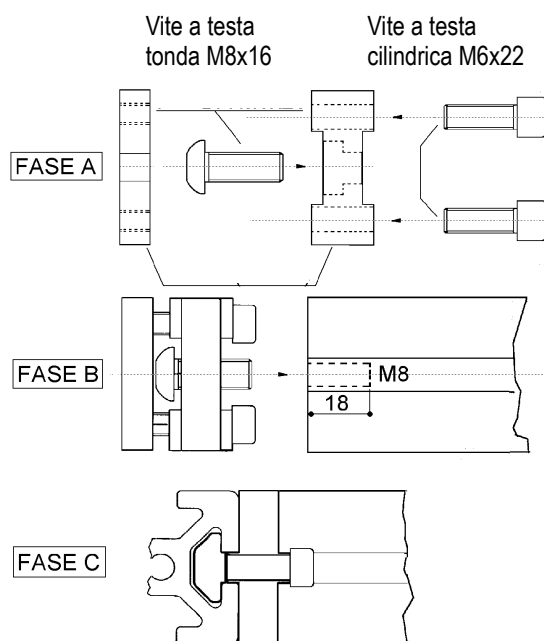

Via Newton, n.12
20016 Pero (Milano - Italy)
Tel.+39 02 3535955 r.a. Fax.+39 02 3539929
E-Mail: info@omar-alluminio.it

Cataloghi Online: www.omar-alluminio.it
www.omar-alluminio.com

PROFILATI ALLUMINIO A DISEGNO / STANDARD / SPECIALI / E PER:
ELETTRONICA / LED / FOTOVOLTAICO / AUTOMAZIONE ROBOTICA / PNEUMATICA / AUTOMOTIVE



ACCESSORI per profili componibili, banchi e linee



modulari - Profili strutturali

Gamma completa per:

-Profili in alluminio con ossidazione naturale in barre o tagliati a misura

-Accessori adatti alla realizzazione di strutture modulari (passare a pag.71 per i disegni dei profili)

Serie 40

Giunto 90°

Giunto in alluminio per collegamenti a 90°.
Utilizzabile con Art.: 726 727 728 729 730 731
732 733 734 739 740 741 742 743 747
Codice Art.3-9131

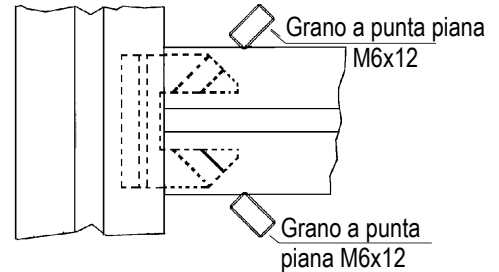
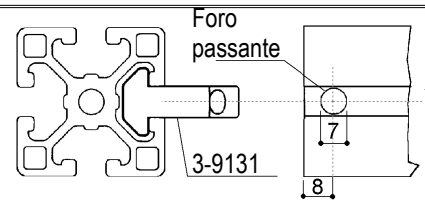

3-9131

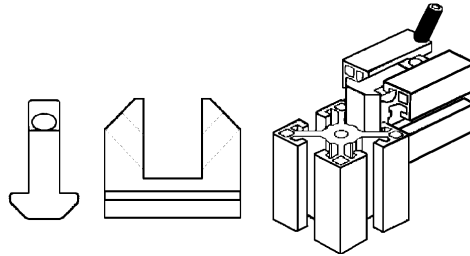

3-5441

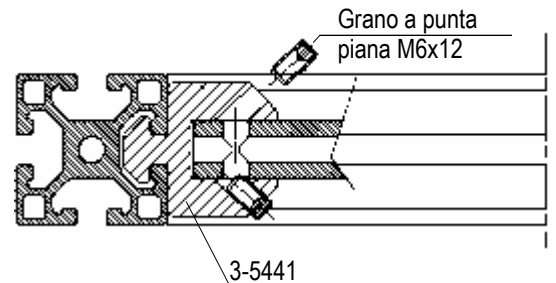
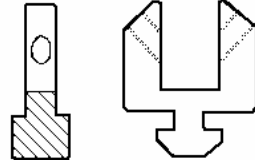

Cataloghi Online: www.omar-alluminio.it

www.omar-alluminio.com

PROFILATI ALLUMINIO A DISEGNO / STANDARD / SPECIALI / E PER:
ELETTRONICA / LED / FOTOVOLTAICO / AUTOMAZIONE ROBOTICA / PNEUMATICA / AUTOMOTIVE

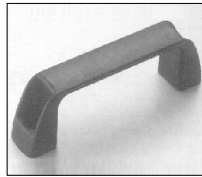

Maniglia in
materiale plastico interasse 122mm.
Cod. Art.3-1131



Maniglia in materiale plastico
antifortunistica.
Cod. Art.3-4021



Blocchetto nero di fissaggio
in plastica.
Codice Art.3-8831



Distanziale in plastica.
Cod. Art.3-9831 distanziale per pannello da 6mm
Cod. Art.3-0931 distanziale per pannello da 5mm
Cod. Art.3-1931 distanziale per pannello da 3mm

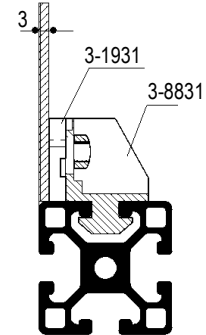
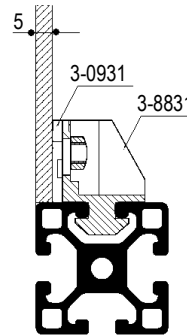
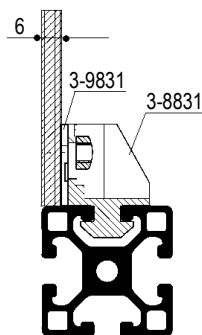
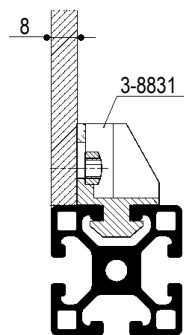

Giunto 90° a 3 vie

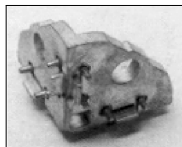

Giunto in alluminio per collegamenti a 90°
3 vie. Utilizzabile con Art.: 750 740
Codice Art.3-3341

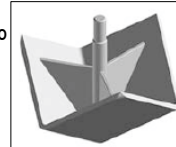

Tappo in nylon nero
quadrato Utilizzabile
con Art.: 740 3-3341
Codice Art.F-0012

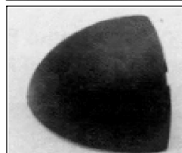

Tappo in nylon nero
Utilizzabile con Art.: 750 3-3341
Cod. Art.3-4341

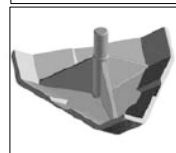

Tappo in nylon nero
trapezoidale Utilizzabile
con Art.: 740 3-3341
Codice Art.F-0013

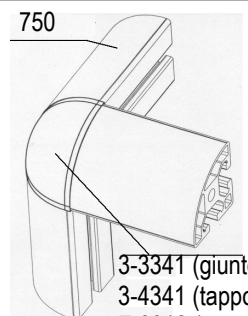

3-3341 (giunto)
3-4341 (tappo)
F-0012 (tappo)
F-0013 (tappo)



Via Newton, n.12

20016 Pero (Milano - Italy)

Tel. +39 02 3535955 r.a. Fax. +39 02 3539929

E-Mail: info@omar-alluminio.it

ACCESSORI per profili componibili, banchi e linee



modulari - Profili strutturali

Gamma completa per:

-Profili in alluminio con ossidazione naturale in barre o tagliati a misura

-Accessori adatti alla realizzazione di strutture modulari (passare a pag.71 per i disegni dei profili)

Serie 40

Giunto 90°

3-2231 (3VIE)

Giunto in alluminio per collegamenti a 90° a 2 o 3 vie. Utilizzabile con Art.: 726 727 728 729 730 731 732 733 734 739 740 741 742 743 747

Codice Art.3-1231 giunto 2 vie

Codice Art.3-2231 giunto 3 vie

Codice Art.3-9041 giunto 2 vie con scasso per tamponamento

Codice Art.3-0141 giunto 3 vie con scasso per tamponamento

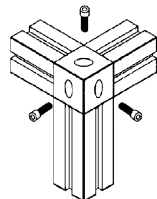

3-9041



3-1231



3-0141



3-2231

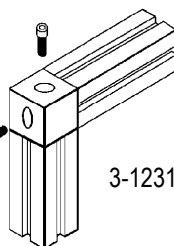

3-1231 (2VIE)

3-1231 (2VIE)

3-2231 (3VIE)

Vite a testa cil. M8

Vite a testa cil. M8

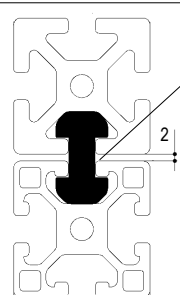
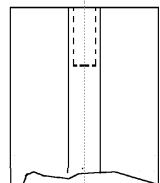
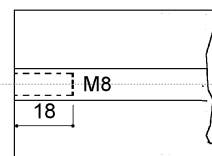
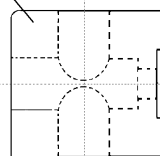
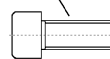
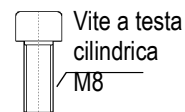

3-8241

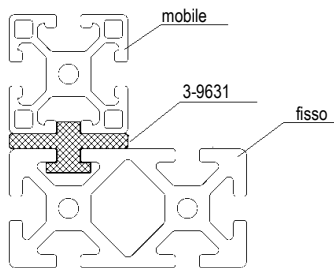

3-9631

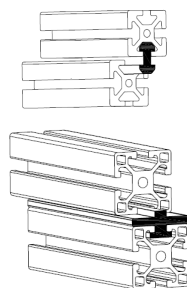

Guide di scorrimento

Guide di scorrimento in materiale plastico.

Lunghezza barre 3mt.

Cod. Art.3-8241

Cod. Art.3-9631

Accessori per l'ancoraggio a terra

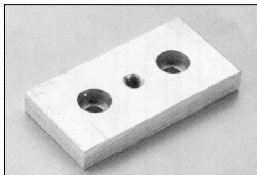

Piastra in alluminio 40x80 adatta a piedi snodati

Utilizzabile con art.726 732

Cod. Art.3-3531 Con foro centrale filettato M8

Cod. Art.3-4531 Con foro centrale filettato M10

Cod. Art.3-5531 Con foro centrale filettato M12

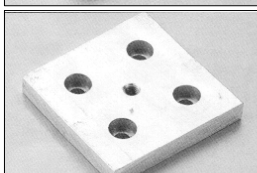

Piastra in alluminio 80x80 adatta a piedi snodati

Utilizzabile con art.729 733

Cod. Art.3-6531 con foro centrale M12

Cod. Art.3-7531 con foro centrale M16

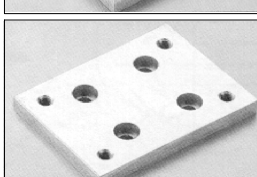

Piastra in alluminio adatta al fissaggio di ruote

Utilizzabile con art.729 733 3-4231 3-5231 3-6231

Cod. Art.3-8531



Ruota girevole in acciaio-gomma

Cod. Art.3-4231 diametro 50mm

Cod. Art.3-5231 diametro 100mm

Cod. Art.3-6231 diametro 100mm con freno

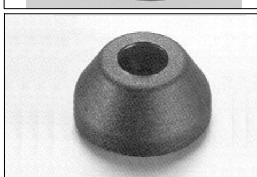

Base diametro 40 in poliammide Utilizzabile con art. 3-4831

3-5831 3-6831 3-7531

Cod. Art.3-8731

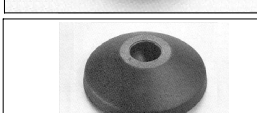

Base diametro 60 in poliammide Utilizzabile con art. 3-4831

3-5831 3-6831 3-7531

Cod. Art.3-0831

ACCESSORI per profili componibili, banchi e linee modulari - Profili strutturali



Gamma completa per:

- Profili in alluminio con ossidazione naturale in barre o tagliati a misura
- Accessori adatti alla realizzazione di strutture modulari (passare a pag.71 per i disegni dei profili)

Serie 40

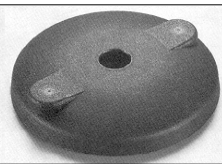

Base diametro 80 in poliammide
Utilizzabile con art. 3-4831 3-5831 3-6831 3-7531
Cod. Art.3-2831

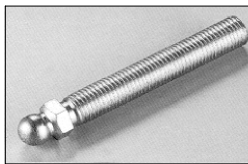

Perno con sfera in acciaio zincato
Cod. Art.3-4831 M8x80
Cod. Art.3-5831 M10x90
Cod. Art.3-6831 M12x100
Cod. Art.3-7831 M16x100

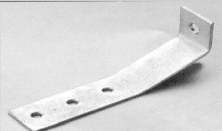

Staffa in acciaio zincato per il fissaggio a terra della struttura
Cod. Art.3-2531 Item no.: 3-2531



Sfera in acciaio zincato
Cod. Art.F-0071 M6
Cod. Art.F-0072 M8

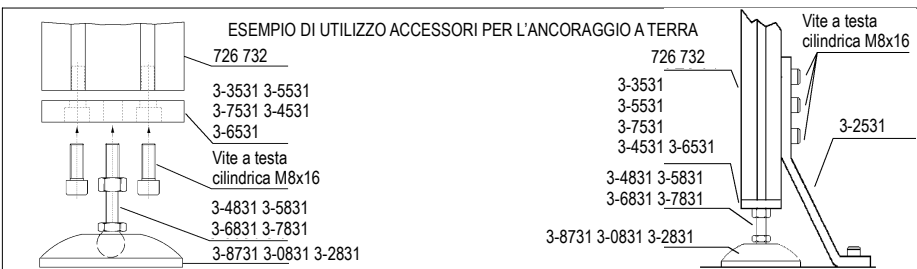

Squadretta di collegamento in alluminio pressofuso per angolazioni da 0° a 180°.
Cod. Art.F-0031



Squadretta di collegamento per angolazioni da 0° a 180°.
Cod. Art.F-0032



Squadretta di collegamento in acciaio zincato per angolazioni da 0° a 180°.
Cod. Art.F-0033

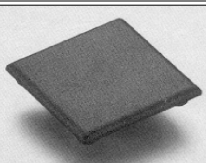

Tappo in nylon nero 40x40
Utilizzabile con art.727 730 731 739
Cod. Art.3-3631

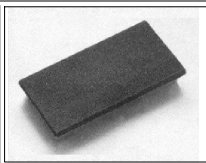

Tappo in nylon nero 40x80
Utilizzabile con art.726 732
Cod. Art.3-5631

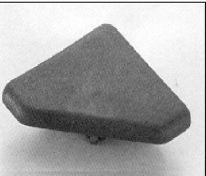

Tappo in nylon nero
Utilizzabile con art.728 740
Cod. Art.3-4631

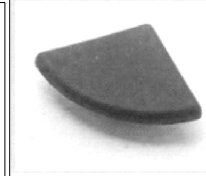

Tappo in nylon nero
Utilizzabile con art.750
Cod. Art.3-6341

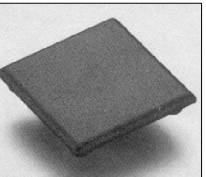

Tappo in nylon nero 80x80
Utilizzabile con art.729 733
Cod. Art.3-6631

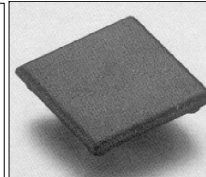

Tappo in nylon nero 60x60
Utilizzabile con art.757
Cod. Art.3-7141

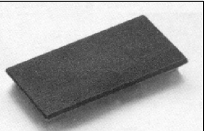

Tappo in nylon nero 30x70
Utilizzabile con art.760
Cod. Art.3-3141

ACCESSORI per profili componibili, banchi e linee



modulari - Profili strutturali

Gamma completa per:

- Profili in alluminio con ossidazione naturale in barre o tagliati a misura
- Accessori adatti alla realizzazione di strutture modulari (passare a pag.71 per i disegni dei profili)

Serie 45

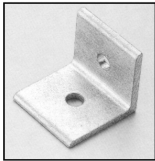

Squadretta in alluminio 40x40x45 burattato
Utilizzabile con art.745 746 748 749 751 752
Codice Art.: 3-7081



Squadretta in alluminio 45x45x90 burattato
Utilizzabile con art.745 746 748 749 751 752
Codice Art.: F-0075

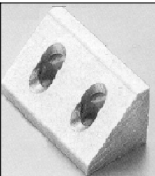
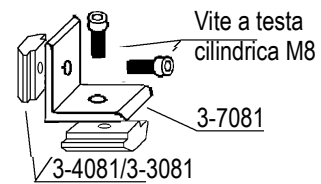
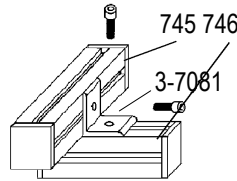

Squadretta in alluminio 40x40x90.
Utilizzabile con art.745 746 748 749 751 752
Codice Art.: 3-9081

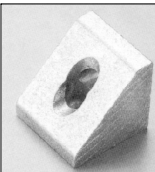

Squadretta in alluminio 40x40x45.
Utilizzabile con art.745 752
Codice Art.: 3-8081

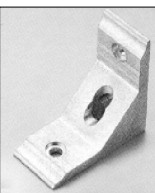
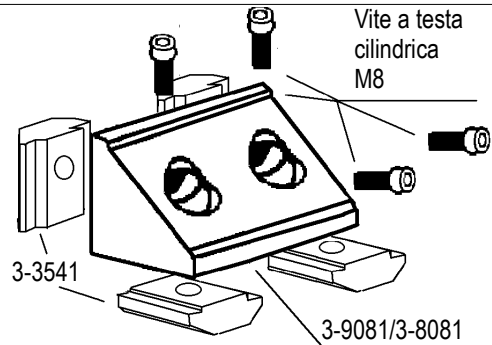

Squadretta in alluminio 80x80x45.
Utilizzabile con art.745 752
Codice Art.: 3-0181



Squadretta in alluminio 80x80x90.
Utilizzabile con art.745 752 746 748 749 751
Codice Art.: 3-1181

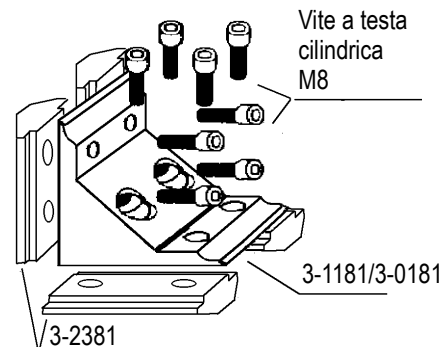

Giunto 90°

Giunto in alluminio per collegamenti a 90° a 2 o 3 vie.

- Codice Art. 3-5181 (3VIE) per profilo cava 8
- Codice Art. 3-4181 (2VIE) per profilo cava 8
- Codice Art. 3-9581 (3VIE) per profilo cava 10
- Codice Art. 3-8581 (2VIE) per profilo cava 10

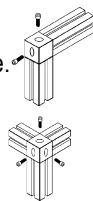

- 3-4181 (2VIE) cava 8
- 3-8581 (2VIE) cava 10

- 3-5181 (3VIE) cava 8
- 3-9581 (3VIE) cava 10

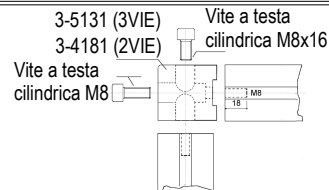

Giunto 90° a 3 vie

Giunto in per collegamenti a 90° 3 vie. Utilizzabile con Art.: 752 360 364
Codice Art.F-0063

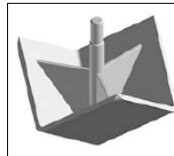
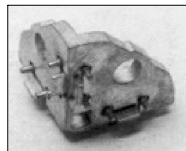

Tappo in nylon nero quadrato
Codice Art.F-0064

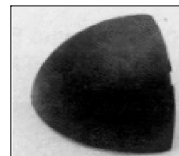

Tappo in nylon stonato nero
Cod. Art.F-0065

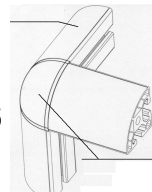

Piastra in alluminio

- Codice Art. F-0079 45x90 per giunzione a 90°
- Codice Art. F-0083 90x90 per collegamento



Esempio utilizzo F-0083



Esempio utilizzo F-0079

Cataloghi Online: www.omar-alluminio.it

www.omar-alluminio.com

PROFILATI ALLUMINIO A DISEGNO / STANDARD / SPECIALI / E PER:
ELETTRONICA / LED / FOTOVOLTAICO / AUTOMAZIONE ROBOTICA / PNEUMATICA / AUTOMOTIVE

Via Newton, n.12
20016 Pero (Milano - Italy)
Tel.+39 02 3535955 r.a. Fax.+39 02 3539929
E-Mail: info@omar-alluminio.it



ACCESSORI per profili componibili, banchi e linee



modulari - Profili strutturali

Gamma completa per:

-Profili in alluminio con ossidazione naturale in barre o tagliati a misura

-Accessori adatti alla realizzazione di strutture modulari (passare a pag.71 per i disegni dei profili)

Serie 45

Giunto in alluminio per collegamenti a 90° singolo (45x45) e doppio (45x90).

Codice Art. 3-4581 (45x45)

Codice Art. 3-5581 (45x90)

Codice Art. 3-6581 (90x90)

ISTRUZIONI PER L'UTILIZZO

FASE A) Montare la vite M8x16 e le viti M6x22 sul giunto

FASE B) Avvitare la vite M8x16 sul profilo

FASE C) Collegare il secondo profilo al giunto

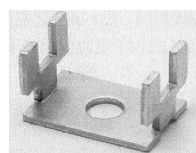
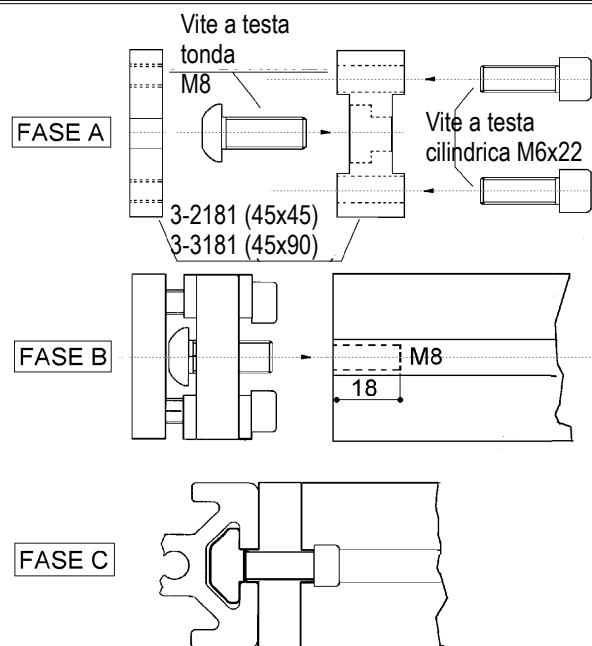
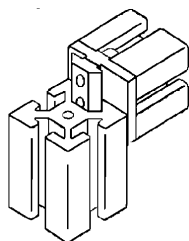

Piastrina in lamiera anti-rotazione per collegamenti 90
Codice Art.: 3-1381 per profilo cava 8
Codice Art.: 3-7581 per profilo cava 10

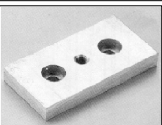
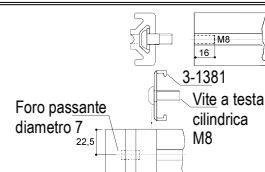
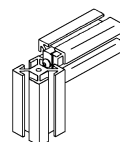

Piastra in alluminio 45x90 con foro M10
Cod. Art.3-0681

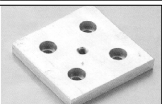

Piastra in alluminio 90x90 con foro M10
Utilizzabile con art.748 Cod. Art.3-3681

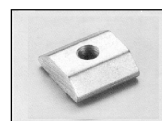

Cursore alluminio lunghezza 21mm con 1 foro M8 - Codice Art.3-3081
Cursore alluminio lunghezza 21mm con 1 foro M10 - Codice Art.3-4081

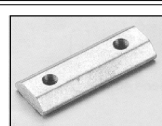

Cursore alluminio lunghezza 65mm con 2 fori M8 interasse 45 mm
Codice Art.3-2381

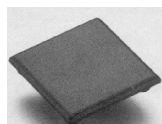

Tappo in nylon nero 45x45
Cod.Art.3-0081

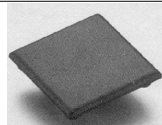

Tappo in nylon nero 90x90
Cod.Art.3-2581



Tappo in nylon nero 90x60
Cod.Art.3-7681 profilo cava 10



Reggicavo (materiale plastico)
Codice Art.F-0060



Collegamento 90° a scomparsa in acciaio zincato per serie 45
Codice Art.F-0067

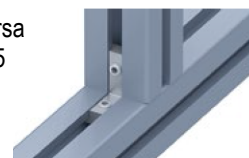

Giunto in metallo 45x45 snodato con brugola per il bloccaggio.
Cod. Art.F-0017



Cerniera con perno diametro 7 mm
Codice Art.3-3281

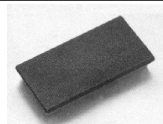

Tappo in nylon nero 45x90
Cod. Art.3-1081 profilo cava 8
Cod.Art.3-1581 profilo cava 10

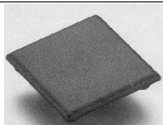

Tappo in nylon nero 90x60
Cod.Art.3-7681 profilo cava 10



Piede regolabile per profili 45x45
Codice Art.F-0059



Cataloghi Online: www.omar-alluminio.it
www.omar-alluminio.com

Via Newton, n.12

20016 Pero (Milano - Italy)

Tel. +39 02 3535955 r.a. Fax. +39 02 3539929

E-Mail: info@omar-alluminio.it

PROFILATI ALLUMINIO A DISEGNO / STANDARD / SPECIALI / E PER:
ELETTRONICA / LED / FOTOVOLTAICO / AUTOMAZIONE ROBOTICA / PNEUMATICA / AUTOMOTIVE

OMAR s.p.a.
PROFILATI ALLUMINIO
ALTA TECNOLOGIA

ACCESSORI per profili componibili, banchi e linee modulari - Profili strutturali



Gamma completa per:

-Profili in alluminio con ossidazione naturale in barre o tagliati a misura

-Accessori adatti alla realizzazione di strutture modulari (passare a pag.71 per i disegni dei profili)

Serie 30



Squadretta in alluminio 30x30x30. Utilizzabile con art.755 769 770 771 785 784
Codice Art.: 3-3741



Vite a testa Cilindrica
3-3741
3-0841



Squadretta in alluminio 30x30x60. Utilizzabile con art.328 755 756 769 770 771 785 784
Codice Art.: F-0073

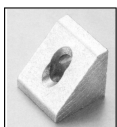

Squadretta in alluminio 30x30x30. Utilizzabile con art.755 769 770 771 785 784
Cod.: 3-4741



Vite
3-4741
3-9741

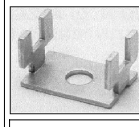

Piastrina in alluminio anti-rotazione per collegamenti 90° Cod.: 3-5741

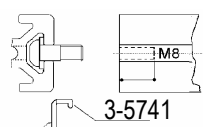

3-5741



Squadretta in alluminio 30x30x60. Utilizzabile con art.328 755 756 769 770 771 785 784
Codice Art.: 3-7741

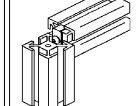

Foro passante diametro 7 per chiave esagonare

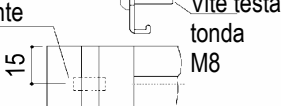

15
Vite testa tonda M8

Piastra in alluminio
Codice Art. F-0077 30x60 per giunzione a 90°
Codice Art. F-0081 60x60 per collegamento

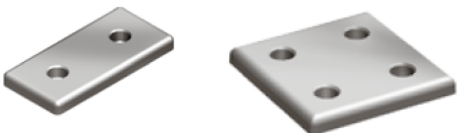



Esempio utilizzo F-0081

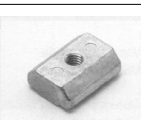

Esempio utilizzo F-0077

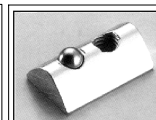

Cursore in zama di fissaggio Utilizzabile con art.755 769 770 771 756
Codice Art.: 3-0841 1 foro M6
Codice Art.: 3-9741 1 foro M5



Cursore in acciaio zincato a 'culla' per montaggio frontale da 21 mm con sferetta
Codice Art.F-0023 1 foro M6
Codice Art.F-0022 1 foro M8.

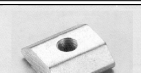

Cursore di fissaggio in alluminio 1 foro M4
Codice Art.: 3-4841



Cursore in acciaio zincato con foro M6.
Cod. Art.3-2741 in acciaio zincato
Cod. Art.3-2741-INOX in acciaio inox

Dado testa quadra M5/M6/M8 a montaggio frontale in acciaio zincato con linguetta
Codice Art. F-0040 M5
Codice Art. F-0039 M6
Codice Art. F-0038 M8





Collegamento 45° 30x30 Utilizzabile con art.755 769 770 771 785
Codice Art.: F-0062

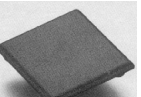

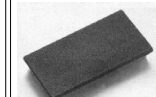
Tappo in nylon nero 30x30 Utilizzabile con art.755 769 770 771
Cod. Art.3-1741



Tappo in nylon nero 30x60 Utilizzabile con art.756
Cod. Art.3-8741 Item no.: 3-8741



Reggi cavo in materiale plastico . Fissare al profilo utilizzando 3-3331 F-0028 etc. Cod.Art.F-0018



Giunto in zinco pressofuso a 90° a 3 vie . Utilizzabile con Art.: 755 769 770 771 785
Codice Art.F-0001



Tappo in plastica nera per giunto 3 vie . Utilizzabile con Art.: F-0001
Codice Art.F-0002



Tappo in plastica nera stonato per giunto 3 vie . Utilizzabile con Art.: F-0001
Codice Art.F-0008



Giunto in metallo 30x30 con snodo e brugola di bloccaggio. Utilizzabile con art.755 769 770 771 784 785 756
Codice Art.: F-0011

Via Newton, n.12

20016 Pero (Milano - Italy)

Tel.+39 02 3535955 r.a. Fax.+39 02 3539929

E-Mail: info@omar-alluminio.it

Cataloghi Online: www.omar-alluminio.it

www.omar-alluminio.com

PROFILATI ALLUMINIO A DISEGNO / STANDARD / SPECIALI / E PER:
ELETTRONICA / LED / FOTOVOLTAICO / AUTOMAZIONE ROBOTICA / PNEUMATICA / AUTOMOTIVE



ACCESSORI per profili componibili, banchi e linee modulari - Profili strutturali



Gamma completa per:

-Profili in alluminio con ossidazione naturale in barre o tagliati a misura

-Accessori adatti alla realizzazione di strutture modulari (passare a pag.71 per i disegni dei profili)

Serie 30

 <p>Morsetto con cuscinetti in gomma per pannelli o vetri spessore 2-10mm Cod. Art.: F-0014</p>	 <p>Giunzione 90° per porta pannello F-0014 Cod. Art.: F-0015</p>
 <p>Piede regolabile per profili 30x30 Codice Art.F-0057</p>	 <p>Reggicavo (materiale plastico) Codice Art.F-0060</p>
 <p>Cerniera con inserto M5 interasse 31 Codice Art.3-2021</p>	 <p>Cerniera alluminio interasse 32 mm Codice Art.3-7331</p>
 <p>Cursore a martello in acciaio zincato filettato M6x30 Codice Art. F-0025</p>	 <p>Collegamento 90° a scomparsa in acciaio zincato per serie 30 Codice Art.F-0067</p>
 <p>Piastra in alluminio per ancoraggio a terra 30x60 con foro M8 art.3-6741 Utilizzabile con art.755 756</p>	 <p>Giunto in alluminio per collegamenti a 90° a 2 o 3 vie 30x30. Codice Art.F-0007 GIUNTO 2 VIE Codice Art.F-0055 GIUNTO 3 VIE</p>

Cataloghi Online: www.omar-alluminio.it
www.omar-alluminio.com

PROFILATI ALLUMINIO A DISEGNO / STANDARD / SPECIALI / E PER:
ELETTRONICA / LED / FOTOVOLTAICO / AUTOMAZIONE ROBOTICA / PNEUMATICA / AUTOMOTIVE

Via Newton, n.12
20016 Pero (Milano - Italy)
Tel.+39 02 3535955 r.a. Fax.+39 02 3539929
E.Mai: info@omar-alluminio.it

OMAR s.r.l.
PROFILATI ALLUMINIO
ALTA TECNOLOGIA

ACCESSORI per profili componibili, banchi e linee modulari - Profili strutturali



Gamma completa per:

- Profili in alluminio con ossidazione naturale in barre o tagliati a misura
- Accessori adatti alla realizzazione di strutture modulari (passare a pag.71 per i disegni dei profili)

Serie 20

	<p>Squadretta in alluminio 40x40x20. Utilizzabile con art.735 736 737 Codice Art.: 3-9531</p> <p>Squadretta in alluminio 20x20x20. Utilizzabile con art.735 736 737 Codice Art.: F-0084</p>	<p>Vite a testa cilindrica 3-9531 F-0084</p> <p>3-4331</p>	<p>Morsetto con cuscinetti in gomma per pannelli o vetri spessore 2-10mm Cod. Art.: F-0014</p>
	<p>Squadretta in alluminio 40x40x20. Material: aluminium.Utilizzabile con art.735 736 737 Codice Art.: 3-7431</p>	<p>Vite a testa cilindrica 3-7431</p> <p>3-3331</p>	<p>F-0014 F-0015</p> <p>Giunzione 90° per porta pannello F-0014 Cod. Art.: F-0015</p>
<p>Giunto in alluminio per collegamenti a 90° a 2 vie 20X20 con tappi .Codice Art.F-0051</p>	<p>Giunto in alluminio per collegamenti a 90° a 3 vie 20X20 con tappi. Codice Art.F-0052</p>		
<p>Piastrina di fissaggio in acciaio Utilizzabile con art.735 736 737 Codice Art.: 3-3331 1 foro M4 Codice Art.: 3-4331 1 foro M5</p>	<p>Cursore in acciaio zincato a 'culla' per montaggio frontale da 12 mm con sferetta. Codice Art.F-0026 1 foro M3 Codice Art.F-0027 1 foro M4 Codice Art.F-0028 1 foro M5</p>		
<p>Giunto in per collegamenti a 90° a 3 vie. Codice Art. F-0068</p>	<p>Tappo in nylon nero quadrato per giunto 3vie Codice Art.F-0069</p>		
<p>Giunto in alluminio 20x20 con snodo e brugola di bloccaggio. Codice Art.: F-0056</p>	<p>Reggi cavo in materiale plastico . Cod.Art.F-0018</p> <p>Tappo in nylon nero 20x20. Utilizzabile con art.735 736 737 Cod. Art.3-1631</p>		

Accessori per profili componibili modulari

Per i disegni dei profili in alluminio andare a pag. 79



<p>Esempio di utilizzo</p> <p>724/725 3-0121 3-9021 3-6121 724/725 716</p>	<p>Giunzione 90° a 2 vie in Nylon Cod. 3-0121 da utilizzare con art. 3-9021 724 725 722</p>	<p>Collegamento in Nylon Cod. 3-9021 da utilizzare con art. 3-0121 3-5121 3-7121</p>
	<p>Giunzione 90° a 3 vie in Nylon Cod. 3-5121 da utilizzare con art. 3-9021 722 724 725</p>	<p>Giunzione 135° a 3 vie in Nylon Cod. 3-6121 da utilizzare con art. 3-9021 716</p>
	<p>Terminale in Nylon Cod. 3-7121 da utilizzare con art.3-9021 722 724 725</p>	<p>Terminale in Nylon con inserto M8 Cod.3-1421 da utilizzare con art. 3-9021 722 724 725</p>
<p>Esempio di utilizzo</p> <p>3-8321 3-9321 721 723</p>	<p>Giunzione a 2 vie in alluminio Cod 3-8321 da utilizzare con art. 721 723</p>	<p>Giunzione a 3 vie in alluminio Cod 3-9321 da utilizzare con art. 721 723</p>

Via Newton, n.12
20016 Pero (Milano - Italy)
Tel.+39 02 3539929
E-Mail: info@omar-alluminio.it

Cataloghi Online: www.omar-alluminio.it
www.omar-alluminio.com
PROFILATI ALLUMINIO A DISEGNO / STANDARD / SPECIALI / E PER:
ELETTRONICA / LED / FOTOVOLTAICO / AUTOMAZIONE ROBOTICA / PNEUMATICA / AUTOMOTIVE



FIERA MILANO RHO - PERO

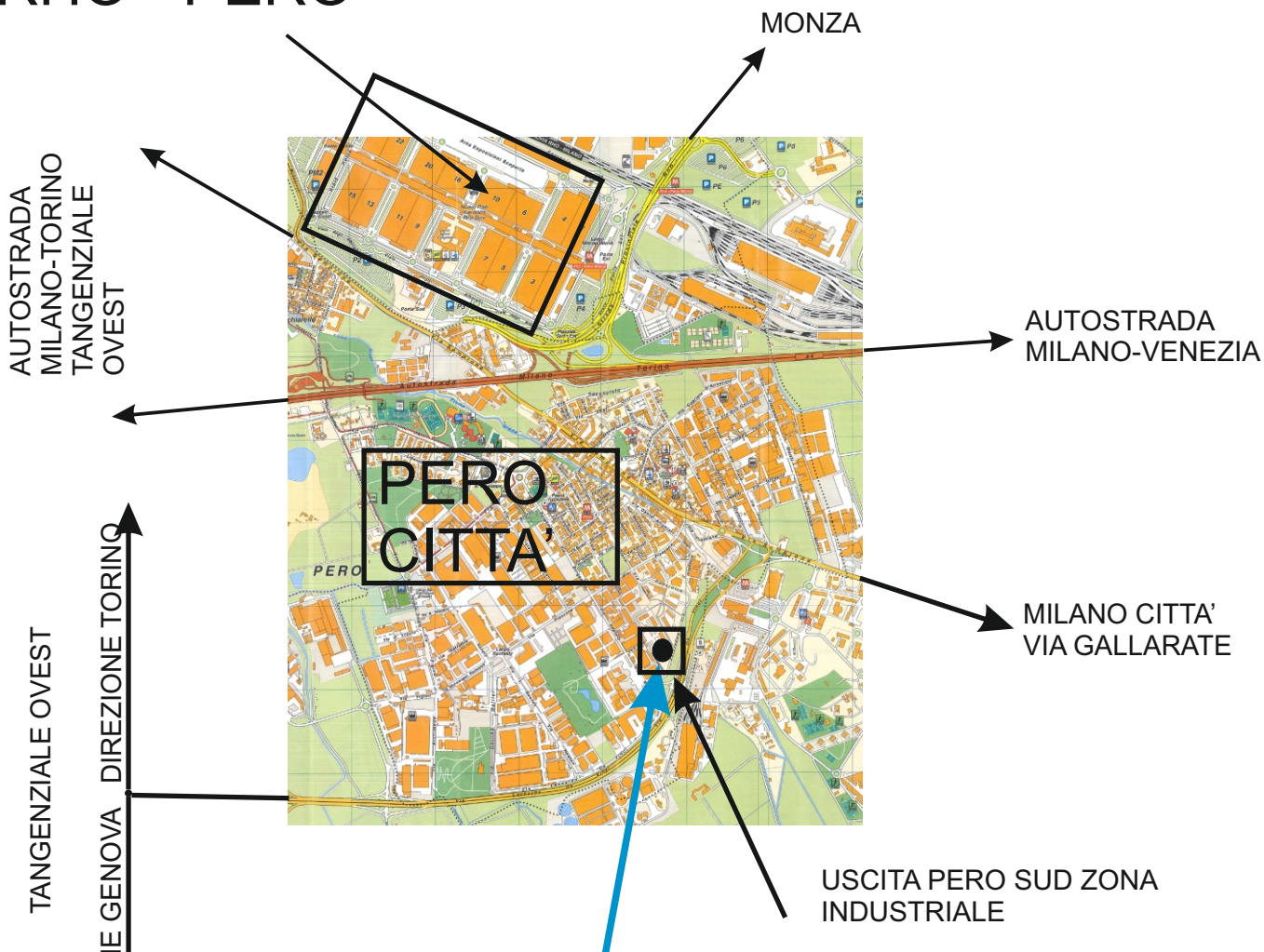

OMAR s.r.l.
PROFILATI ALLUMINIO
ALTA TECNOLOGIA

Via Newton, n.12
20016 Pero (Milano - Italy)
Tel.+39 02 3535955 r.a.
Fax.+39 02 3539929
E.Mail: info@omar-alluminio.it

Consultate il ns. catalogo aggiornato online all'indirizzo:

www.omar-alluminio.it
www.omar-alluminio.com
www.omar-alluminio.eu

PROFILATI IN ALLUMINIO
A DISEGNO-STANDARD-SPECIALI



E PER: ELETTRONICA-LED-FOTOVOLTAICO
AUTOMAZIONE ROBOTICA-PNEUMATICA-AUTOMOTIVE