

°Aluminium profiles according to drawing/standard/special

°Heat sinks in bars

°Heat sinks  
HIGH PERFORMANCE

°LED Heat Sinks

°Heat sinks machined to design and anodized

°Card holders for electronics in aluminum type DIN 43700

°Modular structural profiles for robotics

°Modular structural profiles for PHOTOVOLTAIC installations!



**OMAR** s.r.l.  
PROFILATI ALLUMINIO  
ALTA TECNOLOGIA

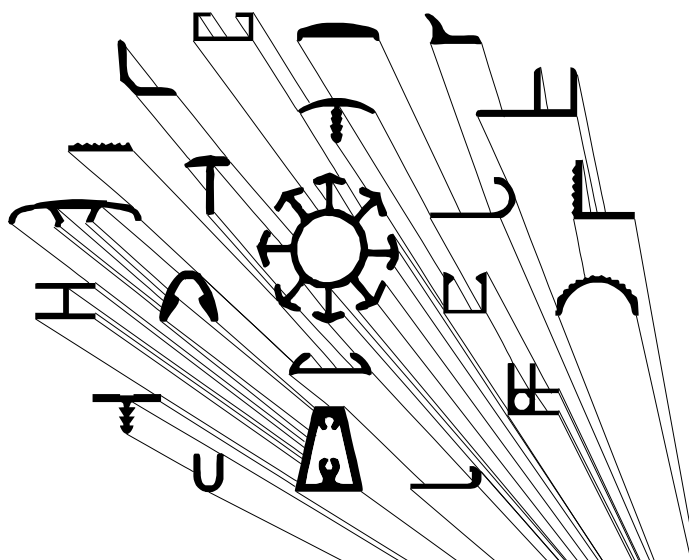

*The "many forms" of the aluminum billet*

STANDARD profiles (channels, plates, angles, tubes, bars etc..)

October 2022 Edition

Consult the updated catalogue online at:

[www.omar-alluminio.it](http://www.omar-alluminio.it)

[www.omar-alluminio.com](http://www.omar-alluminio.com)

[www.angolari-alluminio.it](http://www.angolari-alluminio.it)

[www.canalini-alluminio.it](http://www.canalini-alluminio.it)

[www.piatti-alluminio.it](http://www.piatti-alluminio.it)

[www.tubi-alluminio.it](http://www.tubi-alluminio.it)

°Profiles for pneumatics

°Profiles for stands

°Skirting board profiles  
skirting board covers

°Products derived from aluminum profiles

°Machining aluminum profiles

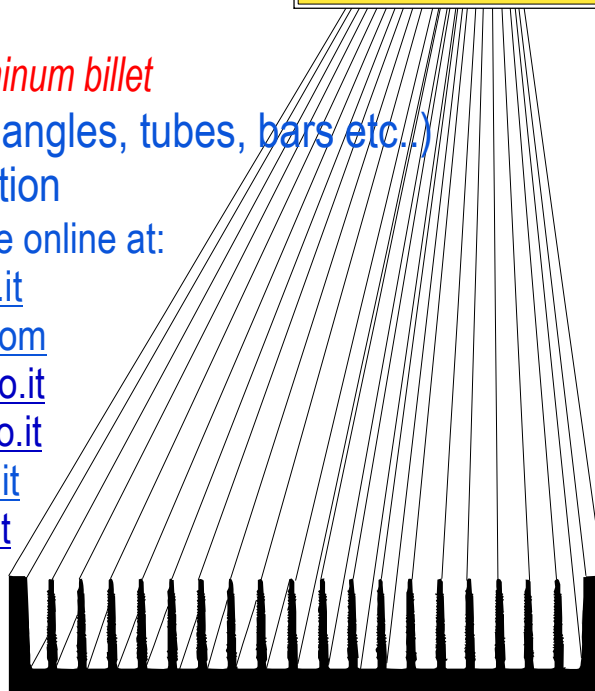

Via Newton, n.12  
20016 Pero (Milano - Italy)  
Tel.+39 02 3535955 r.a.  
Fax.+39 02 3539929  
E.Mail: [info@omar-alluminio.it](mailto:info@omar-alluminio.it)

Production and sale of aluminum profiles: rectangular bars, rectangular bars with rounded edges, simple and double channels, equal-sided angles, unequal-sided angles, square tubes with sharp edges, rectangular tubes with rounded edges, round tubes, round bars, square bars, hexagonal bars, "T" profiles, "Z" profiles, semi-circular and semi-round tubes, round-based channels and profiles for runners, "H" profiles, sliding doors for shop windows, doors / joint covers and drip trays, nails, profiles for tables, desks, kitchens, ribbed plates and angles, profiles for skirting boards and panels, frames and handles, counter-glasses, handrails, profiles for the fitting out of stands, shops, complementary profiles, profiles for roofs and windows price-holder profiles and profiles for elevators, profiles for nautical use, profiles for comb factories, profiles for signs and bins, brush holders

ALUMINUM PROFILES  
CUSTOM-DECORATED-STANDARD-SPECIAL



ELECTRONICS-LED-PHOTOVOLTAIC  
AUTOMATION ROBOTICS-PNEUMATICS-AUTOMOTIVE



PRODUCTION AND SALE OF ALUMINUM PROFILES: RECTANGULAR BARS, RECTANGULAR BARS WITH RADIUS EDGES, SIMPLE AND DOUBLE CHANNELS, EQUAL-SIDED CORNERS, UNEQUAL-SIDED CORNERS, SHARP-EDGED SQUARE TUBES, RECTANGULAR TUBES WITH RADIUS EDGES, ROUND TUBES, ROUND BARS, SQUARE BARS, HEXAGONAL BARS, 'T' PROFILES, 'Z' PROFILES, SEMICIRCULAR AND HALF-ROUND TUBES, ROUND-BASED CHANNELS AND PROFILES FOR RUNNING RUNS, 'H' PROFILES, SLIDING SHOWCASES, SHUTTERS / JOINT COVERS AND DRAINERS, NAIL SLIDES, PROFILES FOR TABLES, DESKS, KITCHENS, LINED PLATES AND CORNERS, PROFILES FOR PLINTH AND PANELS, FRAMES AND HANDLES, GLASS COUNTERS, HANDRAILS, PROFILES FOR STANDS, SHOPS, COMPLEMENTARY PROFILES, PROFILES FOR ROOFING AND GLASS, PRICE HOLDER PROFILES AND PROFILES FOR ELEVATORS, PROFILES FOR NAUTICAL, PROFILES FOR COMB FACTORIES, PROFILES FOR SIGNAGE AND BINS, BRUSH HOLDER SQUEEGEERS

STANDARD PROFILES INDEX		
TYPE		A PAG.
SQUARE TUBES	2	4
RECTANGULAR TUBES	5	11
WIDE BASE CHANNELS	13	19
NARROW BASE CHANNELS	20	22
EQUAL SIDED CHANNELS	23	
DOUBLE CHANNELS	24	
CORNERS	26	27
L-SHAPED PROFILES	28	34
"H" PROFILES	35	36
PROFILES AND "Z"	37	38
"T" PROFILES	39	41
HALF-ROUND BARS	42	
FLAT BARS	44	53
RADIATED FLAT BARS	55	56
FLAT BARS WITH ROUNDED EDGES	58	70
FLAT/SQUARE DRAWN BARS	71	
RADIATED SQUARE TUBES	74	79
RADIATED RECTANGULAR TUBES	80	91
SEMICIRCULAR TUBES	92	93
ROUND TUBES	94	118
ROUND BARS	119	123
SQUARE BAR	124	125
RADIATED SQUARE BARS	126	128
HEXAGONAL BARS	129	130
"CLOSED AND OPEN NAIL" PROFILES	132	133
"C" PROFILES	134	135

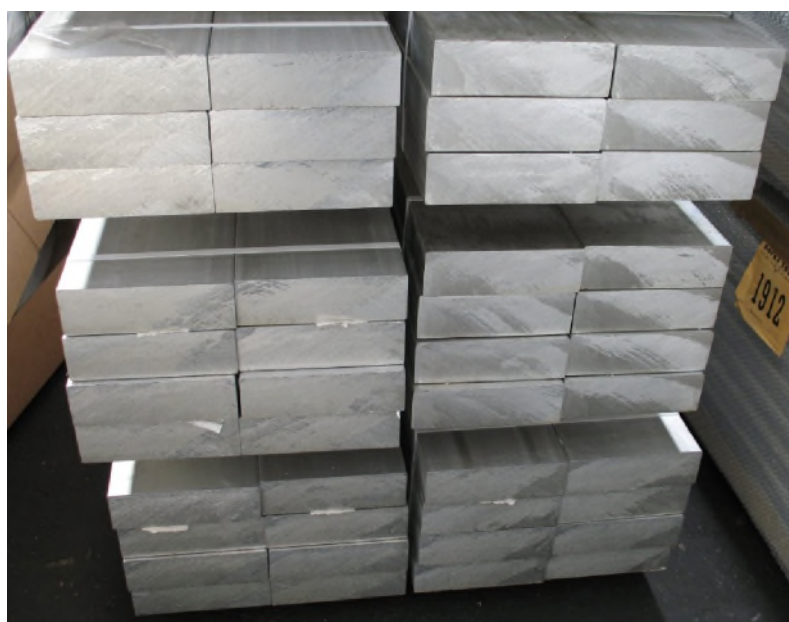

EXAMPLE PHOTO: LARGE FLAT EXTRUDED ALUMINUM PROFILES ALLOY 6060 - 6082

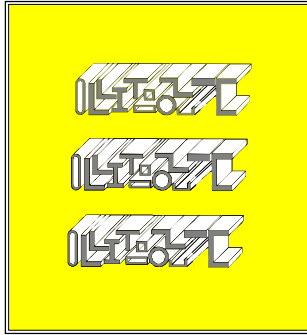

	<a href="http://www.piatti-alluminio.it">www.piatti-alluminio.it</a>
	<a href="http://www.semitondi-alluminio.biz">www.semitondi-alluminio.biz</a>
	<a href="http://www.unghietta-alluminio.biz">www.unghietta-alluminio.biz</a>
	<a href="http://www.angolari-alluminio.it">www.angolari-alluminio.it</a>
	<a href="http://www.canalini-alluminio.it">www.canalini-alluminio.it</a>
	<a href="http://www.profilati-t-alluminio.it">www.profilati-t-alluminio.it</a>
	<a href="http://www.profilati-z-alluminio.it">www.profilati-z-alluminio.it</a>
	<a href="http://www.profilati-h-alluminio.it">www.profilati-h-alluminio.it</a>
	<a href="http://www.travi-alluminio.it">www.travi-alluminio.it</a>
	<a href="http://www.tubi-alluminio.it">www.tubi-alluminio.it</a>
	<a href="http://www.tubi-alluminio.it">www.tubi-alluminio.it</a>
	<a href="http://www.tubi-alluminio.it">www.tubi-alluminio.it</a>
	<a href="http://www.omar-alluminio.it">www.omar-alluminio.it</a>
	(general catalogue)

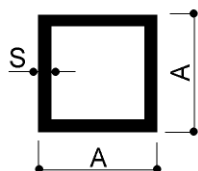

For more sizes of aluminum square tubes visit the site:

[www.tubi-alluminio.it](http://www.tubi-alluminio.it)

## SQUARE TUBES

TUBI QUADRI	A	S	GR/MT	TUBI QUADRI	A	S	GR/MT
TQ 6x6x1	6	1	54	TQ 21x21x1,2	21	1,2	257
TQ 8x8x1	8	1	76	TQ 22x22x1	22	1	226
TQ 9,2x9,2x1	9,2	1	89	TQ 22x22x1,2	22	1,2	270
TQ 9,5x9,5x1	9,5	1	89	TQ 22x22x1,5	22	1,5	332
TQ 10x10x1	10	1	97	TQ 22x22x2	22	2	431
TQ 10x10x1,25	10	1,25	118	TQ 23x23x1,5	23	1,5	348
TQ 10x10x1,5	10	1,5	138	TQ 23,5x23,5x1,2	23,5	1,2	289
TQ 10x10x2	10	2	173	TQ 24x24x1,5	24	1,5	364
TQ 10x10x3	10	3	230	TQ 25x25x1	25	1	259
TQ 10,15x10,15x1,075	10,15	1,075	105	TQ 25x25x1,2	25	1,2	308
TQ 12x12x1	12	1	119	TQ 25x25x1,4	25	1,4	357
TQ 12x12x1,5	12	1,5	170	TQ 25x25x1,5	25	1,5	380
TQ 12x12x2	12	2	216	TQ 25x25x2	25	2	497
TQ 13x13x1	13	1	130	TQ 25x25x2,2	25	2,2	542
TQ 13x13x1,5	13	1,5	186	TQ 25x25x2,5	25	2,5	608
TQ 14x14x1	14	1	140	TQ 25x25x3	25	3	712
TQ 14x14x1,5	14	1,5	202	TQ 25x25x3,5	25	3,5	812
TQ 14,8x14,8x1,8	14,8	1,8	~240	TQ 26x26x1,5	26	1,5	397
TQ 15x15x1	15	1	151	TQ 27x27x1,5	27	1,5	413
TQ 15x15x1,1	15	1,1	~160	TQ 30x30x1	30	1	313
TQ 15x15x1,2	15	1,2	178	TQ 30x30x1,2	30	1,2	373
TQ 15x15x1,4	15	1,4	206	TQ 30x30x1,23	30	1,23	381
TQ 15x15x1,5	15	1,5	219	TQ 30x30x1,5	30	1,5	462
TQ 15x15x2	15	2	281	TQ 30x30x1,8	30	1,8	548
TQ 16x16x1	16	1	162	TQ 30x30x1,9	30	1,9	~590
TQ 16x16x1,5	16	1,5	235	TQ 30x30x2	30	2	605
TQ 16x16x2	16	2	302	TQ 30x30x2,5	30	2,5	713
TQ 16x16x2,5	16	2,5	365	TQ 30x30x3	30	3	875
TQ 19,6x19,6x1,5	19,6	1,5	291	TQ 30x30x4	30	4	1123
TQ 17,8x17,8x1,5	17,8	1,5	264	TQ 30x30x5	30	5	1350
TQ 18x18x1	18	1	183	TQ 32x32x2	32	2	611
TQ 18x18x1,5	18	1,5	267	TQ 34x34x2	34	2	691
TQ 18x18x1,6	18	1,6	283	TQ 34x34x3	34	3	1004
TQ 18x18x2	18	2	346	TQ 35x35x1	35	1	367
TQ 19x19x1,2	19	1,2	231	TQ 35x35x1,2	35	1,2	438
TQ 19x19x1,5	19	1,5	284	TQ 35x35x1,3	35	1,3	470
TQ 20x20x1	20	1	205	TQ 35x35x1,4	35	1,4	508
TQ 20x20x1,2	20	1,2	244	TQ 35x35x1,5	35	1,5	543
TQ 20x20x1,4	20	1,4	281	TQ 35x35x2	35	2	713
TQ 20x20x1,5	20	1,5	300	TQ 35x35x3	35	3	1037
TQ 20x20x2	20	2	389	TQ 35x35x3,8	35	3,8	1280
TQ 20x20x2,2	20	2,2	449	TQ 36x36x1,6	36	36	591
TQ 20x20x2,5	20	2,5	472	TQ 36,7x36,7x1,6	36,7	1,6	606
TQ 20x20x3	20	3	548	TQ 38x38x1,5	38	1,5	591
TQ 20,8x20,8x1,40	20,8	1,4	293	TQ 38x38x2	38	2	778

\* Unless otherwise indicated, profiles are made of EN AW-6060T6 alloy

\* All dimensions are expressed in mm

Via Newton, n.12  
20016 Pero (Milano - Italy)  
Tel. +39 02 3535955 r.a. Fax. +39 02 3539929  
E-Mail: info@omar-alluminio.it

Cataloghi Online: [www.omar-alluminio.it](http://www.omar-alluminio.it)  
[www.omar-alluminio.com](http://www.omar-alluminio.com)

CUSTOM ALUMINUM PROFILES / STANDARD / SPECIAL / AND FOR:  
ELECTRONICS / LED / PHOTOVOLTAIC / ROBOTIC AUTOMATION / PNEUMATICS / AUTOMOTIVE



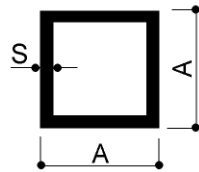

For more sizes of aluminum square tubes visit the site:

[www.tubi-alluminio.it](http://www.tubi-alluminio.it)

## SQUARE TUBES

TUBI QUADRI	A	S	GR/MT	TUBI QUADRI	A	S	GR/MT
TQ 38x38x2,9	38	2,9	1099	TQ 60x60x1,5	60	1,5	948
TQ 38x38x3	38	3	1134	TQ 60x60x1,8	60	1,8	1193
TQ 38x38x3,8	38	3,8	1468	TQ 60x60x2	60	2	1253
TQ 40x40x1	40	1	441	TQ 60x60x2,5	60	2,5	1553
TQ 40x40x1,2	40	1,2	502	TQ 60x60x3	60	3	1847
TQ 40x40x1,5	40	1,5	624	TQ 60x60x4	60	4	2419
TQ 40x40x1,6	40	1,6	664	TQ 60x60x5	60	5	2970
TQ 40x40x1,8	40	1,8	847	TQ 60x60x6	60	6	3499
TQ 40x40x2	40	2	821	TQ 60x60x8	60	8	4493
TQ 40x40x2,5	40	2,5	1012	TQ 62x62x3	62	3	1850
TQ 40x40x3	40	3	1199	TQ 65x65x2	65	2	1361
TQ 40x40x4	40	4	1555	TQ 65x65x2,5	65	2,5	1680
TQ 40x40x5	40	5	1890	TQ 65x65x2,8	65	2,8	1882
TQ 40x40x6	40	6	2203	TQ 70x70x1,8	70	1,8	1326
TQ 40,1x40,1x2	40,1	2	820	TQ 70x70x2	70	2	1469
TQ 42x42x1,5	42	1,5	656	TQ 70x70x3	70	3	2171
TQ 42x42x1,8	42	1,8	782	TQ 70x70x4	70	4	2851
TQ 45x45x1,3	45	1,3	613	TQ 75x75x2	75	2	1576
TQ 45x45x1,35	45	1,35	636	TQ 80x80x2	80	2	1685
TQ 45x45x1,5	45	1,5	705	TQ 80x80x2,2	80	2,2	1858
TQ 45x45x1,7	45	1,7	794	TQ 80x80x2,5	80	2,5	2092
TQ 45x45x2	45	2	930	TQ 80x80x3	80	3	2495
TQ 45x45x2,5	45	2,5	1150	TQ 80x80x4	80	4	3283
TQ 45x45x3	45	3	1360	TQ 80x80x5	80	5	4050
TQ 49x49x1,5	49	1,5	770	TQ 80x80x6	80	6	4972
TQ 50x50x1	50	1	529	TQ 80x80x8	80	8	6221
TQ 50x50x1,1	50	1,1	581	TQ 82x82x2	82	2	1836
TQ 50x50x1,15	50	1,15	606	TQ 85x85x2,5	85	2,5	2228
TQ 50x50x1,2	50	1,2	632	TQ 90x90x2	90	2	1900
TQ 50x50x1,3	50	1,3	684	TQ 90x90x2,5	90	2,5	2362
TQ 50x50x1,4	50	1,4	766	TQ 90x90x4	90	4	3715
TQ 50x50x1,5	50	1,5	794	TQ 91x91x4	91	4	~3800
TQ 50x50x1,9	50	1,9	1007	TQ 100x100x2	100	2	2116
TQ 50x50x2	50	2	1037	TQ 100x100x2,5	100	2,5	2630
TQ 50x50x2,5	50	2,5	1283	TQ 100x100x3	100	3	3143
TQ 50x50x3	50	3	1523	TQ 100x100x4	100	4	4147
TQ 50x50x4	50	4	1987	TQ 100x100x5	100	5	5130
TQ 50x50x5	50	5	2430	TQ 100x100x6	100	6	6091
TQ 50x50x6	50	6	2851	TQ 100x100x8	100	8	7949
TQ 50x50x10	50	10	2430	TQ 100x100x10	100	10	9720
TQ 52x52x2	52	2	1080	TQ 101,5x101,5x2,5	101,5	2,5	2673
TQ 54x54x2	54	2	1123	TQ 101,6x101,6x2,6	101,6	2,6	2789
TQ 55x55x2	55	2	1148	TQ 109x109x4	109	4	4554
TQ 55x55x3	55	3	1684	TQ 120x120x2	120	2	2548
TQ 55x55x5	55	5	2700	TQ 120x120x2,3	120	2,3	2924

\* Unless otherwise indicated, profiles are made of EN AW-6060T6 alloy

\* All dimensions are expressed in mm

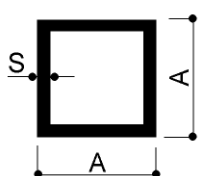

For more sizes of aluminum square tubes visit the site:

[www.tubi-alluminio.it](http://www.tubi-alluminio.it)

## SQUARE TUBES

TUBI QUADRI	A	S	GR/MT	TUBI QUADRI	A	S	GR/MT
TQ 120x120x2,5	120	2,5	3172	TQ 150x150x5	150	5	7830
TQ 120x120x4	120	4	5011	TQ 150x150x8	150	8	12270
TQ 120x120x5	120	5	6210	TQ 150x150x10	150	10	15120
TQ 120x120x8	120	8	9680	TQ 160x160x3	160	3	5087
TQ 120x120x9	120	9	10650	TQ 163x163x3	163	3	5184
TQ 125x125x2	125	2	2657	TQ 170x170x3,5	170	3,5	4943
TQ 125x125x10/12	125	10 e 12	12990	TQ 175x175x4	175	4	7387
TQ 135x135x2,7	135	2,7	3857	TQ 180x180x8	180	8	14861
TQ 135x135x3	135	3	4277	TQ 180x180x12	180	12	10600
TQ 135x135x5	135	5	7020	TQ 200x200x10	200	10	20520
TQ 150x150x2,5	150	2,5	3983	TQ 250x250x6	250	6	15800
TQ 150x150x3	150	3	4763	TQ 250x250x10	250	10	25910
TQ 150x150x4	150	4	6307				

\* Unless otherwise indicated, profiles are made of EN AW-6060T6 alloy

\* All dimensions are expressed in mm



EXAMPLE PHOTO: EXTRUDED ALUMINUM PROFILES FOR ELECTRIC MOTOR CASINGS

Via Newton, n. 12

20016 Pero (Milano - Italy)

Tel. +39 02 3535955 r.a. Fax. +39 02 3539929

E-Mail: [info@omar-alluminio.it](mailto:info@omar-alluminio.it)

Cataloghi Online: [www.omar-alluminio.it](http://www.omar-alluminio.it)

[www.omar-alluminio.com](http://www.omar-alluminio.com)

CUSTOM ALUMINUM PROFILES / STANDARD / SPECIAL / AND FOR:

ELECTRONICS / LED / PHOTOVOLTAIC / ROBOTIC AUTOMATION / PNEUMATICS / AUTOMOTIVE





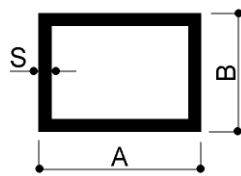

For more dimensions of rectangular aluminum tubes, please visit:

[www.tubi-alluminio.it](http://www.tubi-alluminio.it)

## RECTANGULAR TUBES

TUBI RETTANGOLARI	A	B	S	GR/MT	TUBI RETTANGOLARI	A	B	S	GR/MT
TR 11x8x2	11	8	2	162	TR 25x15x1,6	25	15	1,6	318
TR 11,2x9,20x1	11,2	9,2	1	99	TR 25x15x2	25	15	2	389
TR 12x5x1,2	12	5	1,2	95	TR 25x18x2,5	25	18	2,5	526
TR 12x10x1	12	10	1	108	TR 25x20x1,5	25	20	1,5	340
TR 14x12x2	14	12	2	238	TR 25x20x2	25	20	2	443
TR 15x8x1	15	8	1	114	TR 27x20x1,4	27	20	1,4	~360
TR 15x8x1,5	15	8	1,5	162	TR 27,5x9,6x1,2	27,5	9,6	1,2	224
TR 15x10x1,2	15	10	1,2	146	TR 30x7,5x1	30	7,5	1	192
TR 15x10x1,5	15	10	1,5	178	TR 30x9x1	30	9	1	200
TR 18x10x1,5	18	10	1,5	200	TR 30x10x1	30	10	1	205
TR 18x12x1	18	12	1	151	TR 30x10x1,45	30	10	1,45	290
TR 18x15x1,5	18	15	1,5	250	TR 30x10x1,5	30	10	1,5	300
TR 18,7x16x1,5	18,7	16	1,5	286	TR 30x10x2	30	10	2	389
TR 20x7x1	20	7	1	135	TR 30x13,5x2	30	13,5	2	426
TR 20x8x1	20	8	1	141	TR 30x15x1	30	15	1	232
TR 20x8x1,5	20	8	1,5	110	TR 30x15x1,3	30	15	1,3	297
TR 20x10x1	20	10	1	151	TR 30x15x1,5	30	15	1,5	340
TR 20x10x1,5	20	10	1,5	219	TR 30x15x1,8	30	15	1,8	402
TR 20x10x2	20	10	2	281	TR 30x15x2	30	15	2	443
TR 20x12x1	20	12	1	162	TR 30x15x3	30	15	3	632
TR 20x12x1,5	20	12	1,5	236	TR 30x18x1,2	30	18	1,2	297
TR 20x12x4	20	12	4	518	TR 30x18x2	30	18	2	475
TR 20x15x1	20	15	1	178	TR 30x20x1	30	20	1	259
TR 20x15x1,1	20	15	1,1	194	TR 30x20x1,2	30	20	1,2	308
TR 20x15x1,3	20	15	1,3	272	TR 30x20x1,4	30	20	1,4	356
TR 20x15x1,5	20	15	1,5	259	TR 30x20x1,5	30	20	1,5	381
TR 20x15x2	20	15	2	335	TR 30x20x1,7	30	20	1,7	428
TR 20x15x4/3,35	20	15	4 e 3,35	541	TR 30x20x1,8	30	20	1,8	451
TR 20x18x1,5	20	18	1,5	289	TR 30x20x2	30	20	2	497
TR 21,5x15x1,2/1,5	21,5	15	1,2 e 1,5	253	TR 30x20x2,5	30	20	2,5	607
TR 22x6x1	22	6	1	140	TR 30x20x3	30	20	3	713
TR 22x8x1,5	22	8	1,5	219	TR 30x21,5x2	30	21,5	2	513
TR 22x12x1,5	22	12	1,5	251	TR 30x22x1,5	30	22	1,5	396
TR 22x12x2	22	12	2	~360	TR 30x25x1,5	30	25	1,5	421
TR 24x7,5x1	24	7,5	1	159	TR 30x25x1,8	30	25	1,8	450
TR 24x18x1	24	18	1	216	TR 30x25x2	30	25	2	550
TR 24x18x1,5	24	18	1,5	316	TR 32x19x2	32	19	2	509
TR 25x10x1	25	10	1	178	TR 32x22x2,5	32	22	2,5	661
TR 25x10x1,25	25	10	1,25	219	TR 33x20x1,2	33	20	1,2	338
TR 25x10x1,5	25	10	1,5	259	TR 34x20x2	34	20	2	540
TR 25x10x2	25	10	2	335	TR 34x20x3	34	20	3	778
TR 25x10x2,5	25	10	2,5	405	TR 35x10x1,2	35	10	1,2	276
TR 25x12x1,5	25	12	1,5	275	TR 35x15x1,5	35	15	1,5	380
TR 25x15x1	25	15	1	205	TR 35x15x2	35	15	2	497
TR 25x15x1,2	25	15	1,2	226	TR 35x20x1,2	35	20	1,2	341
TR 25x15x1,5	25	15	1,5	300	TR 35x20x1,4	35	20	1,4	400

\* Unless otherwise indicated, profiles are made of EN AW-6060T6 alloy

\* All dimensions are expressed in mm



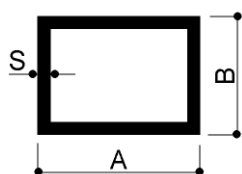

For more dimensions of rectangular aluminum tubes, please visit:

[www.tubi-alluminio.it](http://www.tubi-alluminio.it)

## RECTANGULAR TUBES

TUBI RETTANGOLARI	A	B	S	GR/MT	TUBI RETTANGOLARI	A	B	S	GR/MT
TR 35x20x1,5	35	20	1,5	381	TR 40x30x5	40	30	5	1620
TR 35x20x2	35	20	2	551	TR 40x30x6,5	40	30	6,5	2001
TR 35x20x2,5	35	20	2,5	675	TR 40x35x2	40	35	2	767
TR 35x25x1,5	35	25	1,5	462	TR 40x35x2,5	40	35	2,5	945
TR 35x25x2	35	25	2	605	TR 40x38x1,6	40	38	1,6	649
TR 35x30x2	35	30	2	658	TR 41x22x1,5	41	22	1,5	457
TR 36x10x1,2	36	10	1,2	280	TR 42x15x2	42	15	2	572
TR 36x35,7x1,5	36	35,7	1,5	556	TR 42x8x1,15	42	8	1,15	297
TR 39,5x12,5x1,5	39,5	12,5	1,5	395	TR 42,5x30,5x1,5	42,5	30,5	1,5	567
TR 40x9,5x1,5	40	9,5	1,5	375	TR 43x23x3,5	43	23	3,5	1115
TR 40x10x1	40	10	1	259	TR 43x40x1,5	43	40	1,5	648
TR 40x10x1,5	40	10	1,5	380	TR 45x12x1,2	45	12	1,2	353
TR 40x10x2	40	10	2	497	TR 45x15x2	45	15	2	605
TR 40x15x1,5	40	15	1,5	421	TR 45x20x1,1	45	20	1,1	375
TR 40x15x1,7	40	15	1,7	475	TR 45x20x1,5	45	20	1,5	502
TR 40x15x2	40	15	2	551	TR 45x20x1,6	45	20	1,6	535
TR 40x15x4	40	15	4	1015	TR 45x20x1,8	45	20	1,8	600
TR 40x16x1,8	40	16	1,8	510	TR 45x20x2	45	20	2	659
TR 40x18x1,3	40	18	1,3	389	TR 45x20x3	45	20	3	956
TR 40x20x1	40	20	1	313	TR 45x24x2	45	24	2	702
TR 40x20x1,2	40	20	1,2	373	TR 45x25x1,5	45	25	1,5	543
TR 40x20x1,4	40	20	1,4	432	TR 45x25x2	45	25	2	713
TR 40x20x1,5	40	20	1,5	462	TR 45x30x1,2	45	30	1,2	470
TR 40x20x1,8	40	20	1,8	550	TR 45x30x2	45	30	2	767
TR 40x20x2	40	20	2	606	TR 45x34x3	45	34	3	1183
TR 40x20x2,5	40	20	2,5	742	TR 45x35x3	45	35	3	1200
TR 40x20x2,6	40	20	2,6	769	TR 45,5x12x1,8	45,5	12	1,8	524
TR 40x20x3	40	20	3	875	TR 48x18x1,5	48	18	1,5	~530
TR 40x20x4	40	20	4	1123	TR 48x23x1	48	23	1	372
TR 40x20x5	40	20	5	1349	TR 48x41x3	48	41	3	1345
TR 40x21x2,5	40	21	2,5	756	TR 48,3x18,2x1,5	48,3	18,2	1,5	516
TR 40x22x2	40	22	2	627	TR 49x20x1,2/1,5	49	20	1,2/1,5	461
TR 40x25x1,5	40	25	1,5	502	TR 49x24x1,5	49	24	1,5	567
TR 40x25x1,8	40	25	1,8	624	TR 49,2x20x1,5	49,2	20	1,5	461
TR 40x25x2	40	25	2	659	TR 49,4x14,4x1,2	49,4	14,4	1,2	395
TR 40x25x2,5	40	25	2,5	810	TR 50x10x1,5	50	10	1,5	462
TR 40x25x3	40	29	3	956	TR 50x10x1,8	50	10	1,8	548
TR 40x29x3	40	29	3	~1000	TR 50x10x2	50	10	2	602
TR 40x30x1	40	30	1	367	TR 50x15x1,3	50	15	1,3	438
TR 40x30x1,25	40	30	1,25	456	TR 50x15x1,5	50	15	1,5	502
TR 40x30x1,5	40	30	1,5	543	TR 50x15x2	50	15	2	659
TR 40x30x2	40	30	2	713	TR 50x20x1	50	20	1	367
TR 40x30x2,5	40	30	2,5	877	TR 50x20x1,3	50	20	1,3	473
TR 40x30x2,75	40	30	2,75	955	TR 50x20x1,5	50	20	1,5	543
TR 40x30x3	40	30	3	1037	TR 50x20x1,7	50	20	1,7	610
TR 40x30x4	40	30	4	1339	TR 50x20x1,8	50	20	1,8	645

\* Unless otherwise indicated, profiles are made of EN AW-6060T6 alloy

\* All dimensions are expressed in mm

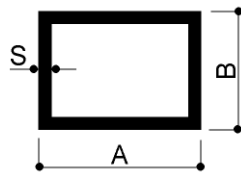

For more dimensions of rectangular aluminum tubes, please visit:

[www.tubi-alluminio.it](http://www.tubi-alluminio.it)

## RECTANGULAR TUBES

TUBI RETTANGOLARI	A	B	S	GR/MT	TUBI RETTANGOLARI	A	B	S	GR/MT
TR 50x20x2	50	20	2	713	TR 60x15x2	60	15	2	770
TR 50x20x3	50	20	3	1037	TR 60x20x1	60	20	1	502
TR 50x20x4	50	20	4	1339	TR 60x20x1,2	60	20	1,2	502
TR 50x23x2	50	23	2	745	TR 60x20x1,4	60	20	1,4	583
TR 50x25x1,5	50	25	1,5	583	TR 60x20x1,5	60	20	1,5	624
TR 50x25x2	50	25	2	767	TR 60x20x1,8	60	20	1,8	755
TR 50x25x2,5	50	25	2,5	945	TR 60x20x2	60	20	2	821
TR 50x25x3	50	25	3	1167	TR 60x20x3	60	20	3	1200
TR 50x25x4	50	25	4	1450	TR 60x20x4	60	20	4	1555
TR 50x30x1,1	50	30	1,1	521	TR 60x21,5x2	60	21,5	2	837
TR 50x30x1,3	50	30	1,3	543	TR 60x24x2,5	60	24	2,5	1066
TR 50x30x1,5	50	30	1,5	624	TR 60x25x2	60	25	2	875
TR 50x30x1,8	50	30	1,8	743	TR 60x25x3	60	25	3	1280
TR 50x30x2	50	30	2	821	TR 60x27x1,5	60	27	1,5	685
TR 50x30x2,5	50	30	2,5	1013	TR 60x30x1	60	30	1	475
TR 50x30x3	50	30	3	1199	TR 60x30x1,05	60	30	1,05	498
TR 50x30x4	50	30	4	1555	TR 60x30x1,1	60	30	1,1	521
TR 50x30x5	50	30	5	1890	TR 60x30x1,2	60	30	1,2	568
TR 50x32x4	50	32	4	1598	TR 60x30x1,25	60	30	1,25	591
TR 50x34x3	50	34	3	1264	TR 60x30x1,3	60	30	1,3	614
TR 50x35x2	50	35	2	870	TR 60x30x1,5	60	30	1,5	705
TR 50x35x3	50	35	3	1280	TR 60x30x1,6	60	30	1,6	751
TR 50x35x4	50	35	4	1660	TR 60x30x1,8	60	30	1,8	840
TR 50x38x1,5	50	38	1,5	688	TR 60x30x2	60	30	2	929
TR 50x40x1,2	50	40	1,2	567	TR 60x30x2,5	60	30	2,5	1148
TR 50x40x2	50	40	2	929	TR 60x30x3	60	30	3	1361
TR 50x40x2,5	50	40	2,5	1147	TR 60x30x4	60	30	4	1771
TR 50x40x3	50	40	3	1361	TR 60x34x3	60	34	3	1426
TR 50x40x4	50	40	4	1771	TR 60x35x1,5	60	35	1,5	786
TR 50x40x5	50	40	5	2159	TR 60x40x1,1	60	40	1,1	528
TR 52x42x1,5	52	42	1,5	737	TR 60x40x1,2	60	40	1,2	631
TR 53x20x1,5	53	20	1,5	1134	TR 60x40x1,3	60	40	1,3	683
TR 53x33x3	53	33	3	1296	TR 60x40x1,5	60	40	1,5	785
TR 53x35x2,5	53	35	2,5	1125	TR 60x40x1,6	60	40	1,6	837
TR 55x15x1,5	55	15	1,5	542	TR 60x40x1,8	60	40	1,8	937
TR 55x15x2	55	15	2	713	TR 60x40x2	60	40	2	1037
TR 55x25x2	55	25	2	821	TR 60x40x2,5	60	40	2,5	1282
TR 55x30x1,5	55	30	1,5	~690	TR 60x40x3	60	40	3	1523
TR 55x30x2	55	30	2	875	TR 60x40x4	60	40	4	2060
TR 57x52x2	57	52	2	1134	TR 60x40x5	60	40	5	2430
TR 57,4x24,4x1,2	57,4	24,4	1,2	501	TR 60x40x6	60	40	6	2850
TR 58x20x3	58	20	3	1166	TR 60x45x2	60	45	2	1091
TR 59,2x29,2x1,1	59,2	29,2	1,1	512	TR 60x50x3	60	50	3	1685
TR 60x10x1,5	60	10	1,5	543	TR 60x50x4	60	50	4	2203
TR 60x13,5x2	60	13,5	2	750	TR 60x50x5	60	50	5	2700
TR 60x15x1,5	60	15	1,5	583	TR 65x10x1,5	65	10	1,5	583

\* Unless otherwise indicated, profiles are made of EN AW-6060T6 alloy

\* All dimensions are expressed in mm

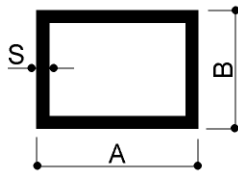

For more dimensions of rectangular aluminum tubes, please visit:

[www.tubi-alluminio.it](http://www.tubi-alluminio.it)

## RECTANGULAR TUBES

TUBI RETTANGOLARI	A	B	S	GR/MT	TUBI RETTANGOLARI	A	B	S	GR/MT
TR 65x15x1,5	65	15	1,5	624	TR 80x9x1,5	80	9	1,5	700
TR 65x20x2	65	20	2	875	TR 80x10x2	80	10	2	929
TR 65x30x2	65	30	2	983	TR 80x12x1,5	80	12	1,5	720
TR 65x35x1,5	65	35	1,5	786	TR 80x15x1,5	80	15	1,5	745
TR 65x40x10/6	65	40	10 e 6	~4100	TR 80x15x1,7	80	15	1,7	841
TR 65x50x2	65	50	2	1199	TR 80x15x2	80	15	2	983
TR 65x50x3	65	50	3	1766	TR 80x18x2	80	18	2	1015
TR 68x36,4x3	68	36,4	3	1594	TR 80x20x1	80	20	1	529
TR 70x10x1,5	70	10	1,5	624	TR 80x20x1,05	80	20	1,05	555
TR 70x10x2	70	10	2	821	TR 80x20x1,1	80	20	1,1	581
TR 70x15x1,5	70	15	1,5	664	TR 80x20x1,2	80	20	1,2	632
TR 70x20x1,3	70	20	1,3	613	TR 80x20x1,3	80	20	1,3	683
TR 70x20x1,5	70	20	1,5	705	TR 80x20x1,5	80	20	1,5	785
TR 70x20x2	70	20	2	929	TR 80x20x1,6	80	20	1,6	837
TR 70x25x1,5	70	25	1,5	745	TR 80x20x2	80	20	2	1037
TR 70x30x1,3	70	30	1,3	684	TR 80x20x4	80	20	4	1986
TR 70x30x1,8	70	30	1,8	937	TR 80x20x4,5	80	20	4,5	2211
TR 70x30x2	70	30	2	1037	TR 80x25x2	80	25	2	1091
TR 70x30x3	70	30	3	1571	TR 80x25x2,5	80	25	2,5	1350
TR 70x35x2	70	35	2	1091	TR 80x30x1,5	80	30	1,5	866
TR 70x40x2	70	40	2	1148	TR 80x30x2	80	30	2	1145
TR 70x40x2,5	70	40	2,5	1417	TR 80x30x3	80	30	3	1685
TR 70x40x3	70	40	3	1685	TR 80x30x4	80	30	4	2203
TR 70x40x4	70	40	4	2203	TR 80x35x3	80	35	3	1726
TR 70x40x5	70	40	5	2699	TR 80x38x2	80	38	2	1230
TR 70x45x2	70	45	2	1199	TR 80x40x1,1	80	40	1,1	702
TR 70x50x1,5	70	50	1,5	947	TR 80x40x1,2	80	40	1,2	762
TR 70x50x2	70	50	2	1307	TR 80x40x1,3	80	40	1,3	823
TR 70x50x2,5	70	50	2,5	1620	TR 80x40x1,4	80	40	1,4	886
TR 70x50x4	70	50	4	2419	TR 80x40x1,5	80	40	1,5	947
TR 70x50x4,5	70	50	4,5	2697	TR 80x40x1,6	80	40	1,6	1010
TR 70x50x5	70	50	5	3120	TR 80x40x1,7	80	40	1,7	1275
TR 70x55x4	70	55	4	2527	TR 80x40x1,8	80	40	1,8	1131
TR 70x65x4	70	65	4	2743	TR 80x40x2	80	40	2	1253
TR 71,4x32,2x1,6	71,4	32,2	1,6	868	TR 80x40x2,5	80	40	2,5	1552
TR 75x25x2	75	25	2	1037	TR 80x40x3	80	40	3	1847
TR 75x28x2	75	28	2	1069	TR 80x40x3,5	80	40	3,5	2230
TR 75x30x2	75	30	2	1092	TR 80x40x4	80	40	4	2419
TR 75x35x2	75	35	2	1144	TR 80x40x4,5	80	40	4,5	2697
TR 75x50x3	75	50	3	1928	TR 80x40x5	80	40	5	2970
TR 75x50x5	75	50	5	3105	TR 80x40x6	80	40	6	3499
TR 75x60x2	75	60	2	1361	TR 80x45x2	80	45	2	1307
TR 76x32,2x4	76	32,2	4	2166	TR 80x45x5	80	45	5	3105
TR 76x44x2	76	44	2	1252	TR 80x50x2	80	50	2	1361
TR 76,2x25,4x3	76,2	25,4	3	1550	TR 80x50x3	80	50	3	2100
TR 79,2x19,2x1	79,2	19,2	1	521	TR 80x50x4	80	50	4	2635

\* Unless otherwise indicated, profiles are made of EN AW-6060T6 alloy

\* All dimensions are expressed in mm

Via Newton, n.12

20016 Pero (Milano - Italy)

Tel. +39 02 3535955 r.a. Fax. +39 02 3539929

E-Mail: [info@omar-alluminio.it](mailto:info@omar-alluminio.it)

Cataloghi Online: [www.omar-alluminio.it](http://www.omar-alluminio.it)

[www.omar-alluminio.com](http://www.omar-alluminio.com)

CUSTOM ALUMINIUM PROFILES / STANDARD / SPECIAL / AND FOR:

ELECTRONICS / LED / PHOTOVOLTAIC / ROBOTIC AUTOMATION / PNEUMATICS / AUTOMOTIVE

**OMAR** s.r.l.  
PROFILATI ALLUMINIO  
ALTA TECNOLOGIA



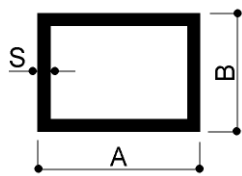

For more dimensions of rectangular aluminum tubes,  
please visit:

[www.tubi-alluminio.it](http://www.tubi-alluminio.it)

## RECTANGULAR TUBES

TUBI RETTANGOLARI	A	B	S	GR/MT	TUBI RETTANGOLARI	A	B	S	GR/MT
TR 80x60x2	80	60	2	1469	TR 100x40x3	100	40	3	2170
TR 80x60x3	80	60	3	2171	TR 100x40x4	100	40	4	2851
TR 80x60x4	80	60	4	2851	TR 100x40x5	100	40	5	3510
TR 80x60x10	80	60	10	6480	TR 100x40x6	100	40	6	4147
TR 81x78x1,5	81	78	1,5	1263	TR 100x40x7	100	40	7	4763
TR 85x15x1,5	85	15	1,5	786	TR 100x45x2	100	45	2	1523
TR 85x30x1,5	85	30	1,5	907	TR 100x48x1,8	100	48	1,8	1404
TR 85x40x3,5	85	40	3,5	2230	TR 100x50x1,8	100	50	1,8	1423
TR 90x20x1,5	90	20	1,5	867	TR 100x50x2	100	50	2	1577
TR 90x40x2	90	40	2	1362	TR 100x50x2,5	100	50	2,5	1956
TR 90x40x3	90	40	3	2009	TR 100x50x3	100	50	3	2333
TR 90x60x2	90	60	2	1576	TR 100x50x4	100	50	4	3067
TR 90x70x3	90	70	3	2851	TR 100x50x5	100	50	5	3780
TR 94x15x2	94	15	2	~1170	TR 100x60x2	100	60	2	1685
TR 99x17x1,6	99	17	1,6	975	TR 100x60x2,5	100	60	2,5	2093
TR 99,8x17,5x1	99,8	17,5	1	664	TR 100x60x3	100	60	3	2495
TR 99,8x17,8x1	99,8	17,8	1	667	TR 100x60x4	100	60	4	3283
TR 100x15x2	100	15	2	1199	TR 100x60x5	100	60	5	4050
TR 100x18	100	18		797	TR 100x70x2,5	100	70	2,5	2228
TR 100x18x2	100	18	2	1231	TR 100x70x5	100	70	5	4320
TR 100x18x4	100	18	4	1231	TR 100x75x3	100	75	3	2738
TR 100x20x1,3	100	20	1,3	886	TR 100x80x2	100	80	2	1901
TR 100x20x1,5	100	20	1,5	948	TR 100x80x2,5	100	80	2,5	2362
TR 100x20x1,8	100	20	1,8	1130	TR 100x80x3	100	80	3	2819
TR 100x20x2	100	20	2	1253	TR 100x80x4	100	80	4	3715
TR 100x20x2,5	100	20	2,5	1553	TR 100,2x25,2x1,5	100,2	25,2	1,5	991
TR 100x22,4x2	100	22,4	2	1279	TR 105x50x4	105	50	4	3175
TR 100x25x1,2	100	25	1,2	794	TR 106x46x2	106	46	2	1598
TR 100x25x1,25	100	25	1,25	826	TR 110x20x2,5	110	220	2,5	1688
TR 100x25x1,3	100	25	1,3	860	TR 110x40x4	110	40	4	3066
TR 100x25x1,4	100	25	1,4	924	TR 110x45x2	110	45	2	1631
TR 100x25x1,5	100	25	1,5	988	TR 110x50x2	110	50	2	3173
TR 100x25x1,7	100	25	1,7	1116	TR 110x50x2,5	110	50	2,5	2093
TR 100x25x1,75	100	25	1,75	1153	TR 115x55x2	115	55	2	1793
TR 100x25x2	100	25	2	1307	TR 116x40x1,7	116	40	1,7	~1600
TR 100x30x1,2	100	30	1,2	827	TR 120x15x1,5	120	15	1,5	1069
TR 100x30x1,25	100	30	1,25	860	TR 120x15x1,8	120	15	1,8	1277
TR 100x30x1,3	100	30	1,3	894	TR 120x15x2	120	15	2	1415
TR 100x30x1,5	100	30	1,5	1029	TR 120x18x2	120	18	2	1440
TR 100x30x2	100	30	2	1361	TR 120x20x2	120	20	2	1469
TR 100x30x2,5	100	30	2,5	1688	TR 120x25x1,4	120	25	1,4	1177
TR 100x30x3	100	30	3	2009	TR 120x25x2	120	25	2	1700
TR 100x40x1,5	100	40	1,5	1110	TR 120x30x2	120	30	2	1577
TR 100x40x1,7	100	40	1,7	1254	TR 120x30x2,5	120	30	2,5	1958
TR 100x40x2	100	40	2	1469	TR 120x30x3	120	30	3	2333
TR 100x40x2,5	100	40	2,5	1823	TR 120x30x4	120	30	4	3067

\* Unless otherwise indicated, profiles are made of EN AW-6060T6 alloy

\* All dimensions are expressed in mm

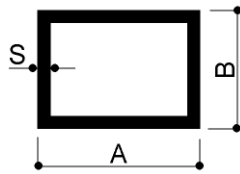

For more dimensions of rectangular aluminum tubes, please visit:

[www.tubi-alluminio.it](http://www.tubi-alluminio.it)

## RECTANGULAR TUBES

TUBI RETTANGOLARI	A	B	S	GR/MT	TUBI RETTANGOLARI	A	B	S	GR/MT
TR 120x40x1,4	120	40	1,4	1188	TR 140x60x10	140	60	10	9790
TR 120x40x1,9	120	40	1,9	1604	TR 140x80x2,5	140	80	2,5	2903
TR 120x40x2	120	40	2	1685	TR 140x80x4	140	80	4	4579
TR 120x40x2,5	120	40	2,5	2092	TR 140x80x6	140	80	6	6739
TR 120x40x4	120	40	4	3283	TR 140x90x2	140	90	2	2233
TR 120x42,5x1,5	120	42,5	1,5	1295	TR 140x110x5	140	110	5	6480
TR 120x45x2	120	45	2	1739	TR 145x40x2	145	40	2	1955
TR 120x50x1,5	120	50	1,5	1353	TR 146x110x2,3	146	110	2,3	3122
TR 120x50x2	120	50	2	1793	TR 149,5x50x2	149,5	50	2	2111
TR 120x50x2,5	120	50	2,5	2227	TR 150x17,8x1,6	150	17,8	1,6	1422
TR 120x50x3	120	50	3	2657	TR 150x18x2	150	18	2	1771
TR 120x50x4	120	50	4	3499	TR 150x20x1,8	150	20	1,8	1620
TR 120x50x5	120	50	5	~4550	TR 150x20x2	150	20	2	1792
TR 120x50x6	120	50	6	5119	TR 150x25x2	150	25	2	1850
TR 120x60x2	120	60	2	1901	TR 150x30x2	150	30	2	1901
TR 120x60x2,5	120	60	2,5	2362	TR 150x30x2,5	150	30	2,5	2363
TR 120x60x3	120	60	3	2819	TR 150x30x2,8	150	30	2,8	2637
TR 120x60x4	120	60	4	3715	TR 150x40x2	150	40	2	2010
TR 120x60x5	120	60	5	4725	TR 150x40x4	150	40	4	3931
TR 120x70x1,9	120	70	1,9	1912	TR 150x50x2	150	50	2	2117
TR 120x80x3	120	80	3	3143	TR 150x50x2,5	150	50	2,5	2632
TR 120x80x4	120	80	4	4148	TR 150x50x3	150	50	3	3143
TR 120x80x10	120	80	10	9722	TR 150x50x4	150	50	4	4147
TR 120x90x4	120	90	4	4363	TR 150x50x5	150	50	5	5116
TR 123x23x1,5	123	23	1,5	1156	TR 150x56x2,5	150	56	2,5	2715
TR 125x30x1,5	125	30	1,5	1231	TR 150x60x2	150	60	2	2225
TR 125x65x2	125	65	2	2008	TR 150x60x2,5	150	60	2,5	2768
TR 130x50x4	130	50	4	3715	TR 150x60x3	150	60	3	3305
TR 130x60x3	130	60	3	2981	TR 150x60x4	150	60	4	4363
TR 130x70x2	130	70	2	2117	TR 150x70x2,5	150	70	2,5	2903
TR 132x28x2	132	28	2	~1700	TR 150x75x8	150	75	8	9029
TR 140x15x2,5	140	15	2,5	2025	TR 150x80x4	150	80	4	4795
TR 140x18x2	140	18	2	1663	TR 150x80x6	150	80	6	7120
TR 140x20x2	140	20	2	1685	TR 150x100x3	150	100	3	3953
TR 140x20x3	140	20	3	2495	TR 150x100x4	150	100	4	5227
TR 140x25x2	140	25	2	1738	TR 150x100x5	150	100	5	6480
TR 140x35x3	140	35	3	2698	TR 150x100x6	150	100	6	7710
TR 140x40x2	140	40	2	1901	TR 155x40x2	155	40	2	2063
TR 140x40x2,5	140	40	2,5	2093	TR 155x150x15	155	150	15	22275
TR 140x40x4	140	40	4	3715	TR 160x40x2	160	40	2	2116
TR 140x45x2	140	45	2	1955	TR 160x40x4	160	40	4	4147
TR 140x45x4	140	45	4	3820	TR 160x50x3	160	50	3	3305
TR 140x50x4	140	50	4	3931	TR 160x50x4	160	50	4	4363
TR 140x60x2	140	60	2	2117	TR 160x60x4	160	60	4	4579
TR 140x60x2,5	140	60	2,5	2632	TR 160x80x2,5	160	80	2,5	3173
TR 140x60x4	140	50	4	4147	TR 160x80x4	160	80	4	5011

\* Unless otherwise indicated, profiles are made of EN AW-6060T6 alloy

\* All dimensions are expressed in mm

Via Newton, n.12

20016 Pero (Milano - Italy)

Tel. +39 02 3535955 r.a. Fax. +39 02 3539929

E-Mail: [info@omar-alluminio.it](mailto:info@omar-alluminio.it)

Cataloghi Online: [www.omar-alluminio.it](http://www.omar-alluminio.it)

[www.omar-alluminio.com](http://www.omar-alluminio.com)

CUSTOM ALUMINIUM PROFILES / STANDARD / SPECIAL / AND FOR:

ELECTRONICS / LED / PHOTOVOLTAIC / ROBOTIC AUTOMATION / PNEUMATICS / AUTOMOTIVE

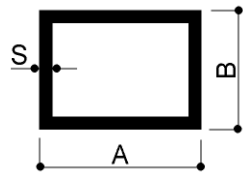

For more dimensions of rectangular aluminum tubes, please visit:

[www.tubi-alluminio.it](http://www.tubi-alluminio.it)

## RECTANGULAR TUBES

TUBI RETTANGOLARI	A	B	S	GR/MT	TUBI RETTANGOLARI	A	B	S	GR/MT
TR 160x100x3,5	160	100	3,5	4779	TR 200x40x2,5	200	40	2,5	3173
TR 160x100x5	160	100	5	6750	TR 200x40x3	200	40	3	3791
TR 168x72x4	168	72	4	4900	TR 200x40x4	200	40	4	5011
TR 170x45x2	170	45	2	2279	TR 200x50x2	200	50	2	2657
TR 170x70x4	170	70	4	5011	TR 200x50x2,5	200	50	2,5	3308
TR 175x50x3	175	50	3	3548	TR 200x50x3	200	50	3	3953
TR 180x30x2	180	30	2	2225	TR 200x50x3,5	200	50	3,5	4592
TR 180x40x2	180	40	2	2332	TR 200x50x4	200	50	4	5227
TR 180x40x2,5	180	40	2,5	2903	TR 200x60x4	200	60	4	5443
TR 180x40x3	180	40	3	~2750	TR 200x70	200	70		3230
TR 180x40x4	180	40	4	4579	TR 200x70x8	200	70	8	10973
TR 180x50x3	180	50	3	3629	TR 200x80x4	200	80	4	5873
TR 180x50x4	180	50	4	4795	TR 200x100x4	200	100	4	6307
TR 180x50x8	180	50	8	9245	TR 200x100x5	200	100	5	7830
TR 180x60x2,5	180	60	2,5	3172	TR 200x100x6	200	100	6	9331
TR 180x60x3	180	60	3	3791	TR 200x150x2,5	200	150	2,5	4657
TR 180x60x4	180	60	4	5011	TR 216,7x131,7x3,3	216,7	131,7	3,3	5810
TR 180x75x2	180	75	2	2711	TR 220x35x2,7	220	35	2,7	3640
TR 180x90x5	180	90	5	7020	TR 220x140x4	220	140	4	7603
TR 180x100x3	180	100	3	4439	TR 240x100x5	240	100	5	8910
TR 180x100x8	180	100	8	11405	TR 250x50x3	250	50	3	4763
TR 180x120x2,7	180	120	2,7	4296	TR 250x50x4	250	50	4	6307
TR 183,2x50,2x2,2	183,2	50,2	2,2	2722	TR 250x52x3	250	52	3	4813
TR 190x60x3	190	60	3	3953	TR 250x100x4	250	100	4	7387
TR 190x80x3	190	80	3	4277	TR 250x140x8	250	140	8	16157
TR 200x8x4	200	8	4	4320	TR 260x250x10	260	250	10	26500
TR 200x18x2	200	18	2	2376	TR 270x40x3	270	40	3	5200
TR 200x20x2	200	20	2	2506	TR 300x50x2,5	300	50	2,5	4585
TR 200x30x2,8	200	30	2,8	3393	TR 300x80x5	300	80	5	9990
TR 200x40x2	200	40	2	2549	TR 330x35x3	330	35	3	6288

\* Unless otherwise indicated, profiles are made of EN AW-6060T6 alloy

\* All dimensions are expressed in mm

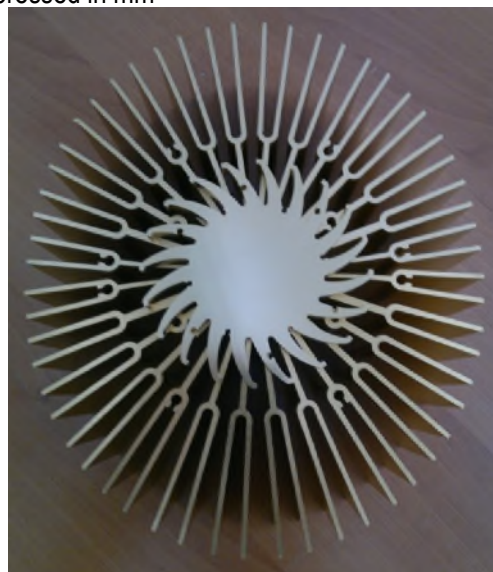

EXAMPLE PHOTO: ALUMINUM PROFILES  
EXTRUDED HEAT SINKS  
LARGE ROUND " FLOWER "



[General catalogue  
www.omar-alluminio.it](http://www.omar-alluminio.it)



EXAMPLE PHOTO: LARGE BOXED ALUMINUM PROFILES



EXAMPLE PHOTO: ALUMINIUM PROFILES WITH FINISHES,  
EVEN LARGE DIMENSIONS



EXAMPLE PHOTO: ALUMINUM PROFILES  
CUSTOM PROFILES



EXAMPLE PHOTO: ALUMINUM EXTRUDED PARTS FOR  
LIGHTING BODIES

Via Newton, n.12  
20016 Pero (Milano - Italy)  
Tel. +39 02 3535955 r.a. Fax. +39 02 3539929  
E-Mail: info@omar-alluminio.it

Cataloghi Online: [www.omar-alluminio.it](http://www.omar-alluminio.it)  
[www.omar-alluminio.com](http://www.omar-alluminio.com)  
CUSTOM ALUMINIUM PROFILES / STANDARD / SPECIAL / AND FOR:  
ELECTRONICS / LED / PHOTOVOLTAIC / ROBOTIC AUTOMATION / PNEUMATICS / AUTOMOTIVE





For more dimensions of aluminum channels, visit the site:

[www.canalini-alluminio.it](http://www.canalini-alluminio.it)

## WIDE BASE CHANNELS

CANALINI BASE LARGA	A	B	S	GR/MT	CANALINI BASE LARGA	A	B	S	GR/MT
CL 7,5x7x1,2	7,5	7	1,2	62	CL 20x10x1,2	20	10	1,2	122
CL 7,5x15x2	7,5	15	2	~180	CL 20x10x1,5	20	10	1,5	150
CL 8,6x8x1	8,6	8	1	62	CL 20x10x2	20	10	2	194
CL 10x5x1	10	5	1	49	CL 20x12x1	20	12	1	113
CL 10x8x1	10	8	1	65	CL 20x12x1,5	20	12	1,5	165
CL 10,9x9,5x1,57	10,9	9,5	1,57	113	CL 20x13x1	20	13	1	119
CL 11x6x1	11	6	1	57	CL 20x15x1,2	20	15	1,2	154
CL 11x8x1	11	8	1	76	CL 20x15x1,5	20	15	1,5	190
CL 12x5x1,5	12	5	1,5	77	CL 20x15x2	20	15	2	248
CL 12x10x2	12	10	2	151	CL 20x15x3	20	15	3	357
CL 12x10,6x1	12	10,6	1	83	CL 20x16x1	20	16	1	135
CL 12x11,7x1	12	11,7	1	90	CL 20x18x1	20	18	1	146
CL 13x10x1,5	13	10	1,5	122	CL 20x19x1	20	19	1	157
CL 13x12x1,3	13	12	1,3	119	CL 20x19x1,5	20	19	1,5	223
CL 13,5x8x1,5	13,5	8	1,5	107	CL 20,5x18x1	20,5	18	1	147
CL 14x10,5x2	14	10,5	2	167	CL 21x11,7x1	21	11,7	1	138
CL 15x7x1,2	15	7	1,2	86	CL 21x13x3	21	13	3	332
CL 15x10x1	15	10	1	95	CL 21x14x2	21	14	2	243
CL 15x10x1,5	15	10	1,5	130	CL 21,4x8x1,2	21,4	8	1,2	113
CL 15x10x2	15	10	2	167	CL 22x8,3x1,5	22	8,3	1,5	144
CL 15x10,5x2	15	10,5	2	173	CL 22x10x2	22	10	2	205
CL 15x12x1,2	15	12	1,2	115	CL 22x15x1,5	22	15	1,5	198
CL 15x12x1,5	15	12	1,5	145	CL 22x15x2	22	15	2	259
CL 15,5x15x1,5	15,5	15	1,5	173	CL 22x15x3	22	15	3	373
CL 16x11x2	16	11	2	184	CL 22x16x2	22	16	2	265
CL 16x13x1,5	16	13	1,5	158	CL 22x20x2	22	20	2	313
CL 16x13x3	16	13	3	290	CL 22,5x10x1,5	22,5	10	1,5	160
CL 17x7x3	17	7	3	203	CL 23x4x1,5	23	4	1,5	113
CL 17x15x2	17	15	2	232	CL 23x10x1,5	23	10	1,5	162
CL 17x16x4	17	16	4	445	CL 23x10x1,60	23	10	1,6	172
CL 18x7,5x1,3	18	7,5	1,3	105	CL 23x20x1,5	23	20	1,5	243
CL 18x13x1,2	18	13	1,2	135	CL 23,4x14,2x1,2	23,4	14,2	1,2	160
CL 18x13x2	18	13	2	216	CL 23,5x10x1,5	23,5	10	1,5	164
CL 18x15x1,5	18	15	1,5	182	CL 23,5x14x1,3	23,5	14	1,3	172
CL 18x15x2	18	15	2	238	CL 24x5x1,5	24	5	1,5	127
CL 18,3x15x2	18,3	15	2	239	CL 24x5,5x3	24	5,5	3	235
CL 18,3x18x2	18,3	18	2	167	CL 24x12x2	24	12	2	238
CL 18,4x10x1,7	18,4	10	1,7	155	CL 24x12,2	24	12,2		~260
CL 19x10x1,5	19	10	1,5	146	CL 25x4x1,2	25	4	1,2	100
CL 19x14x2	19	14	2	232	CL 25x4x1,3	25	4	1,3	107
CL 19,5x10x1,5	19,5	10	1,5	149	CL 25x10x1,5	25	10	1,5	170
CL 20x5x1	20	5	1	76	CL 25x10x1,9	25	10	1,9	211
CL 20x7x1,5	20	7	1,5	120	CL 25x10x2	25	10	2	221
CL 20x8x1	20	8	1	92	CL 25x10x2,5	25	10	2,5	270
CL 20x8x1,1	20	8	1,1	91	CL 25x10x4	25	10	4	400
CL 20x8x2	20	8	2	173	CL 25x12x1,5	25	12	1,5	186
CL 20x10x1	20	10	1	103	CL 25x12x2	25	12	2	243

\* Unless otherwise indicated, profiles are made of EN AW-6060T6 alloy

\* All dimensions are expressed in mm



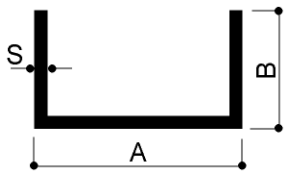

For more dimensions of aluminum channels, visit the site:

[www.canalini-alluminio.it](http://www.canalini-alluminio.it)

## WIDE BASE CHANNELS

CANALINI BASE LARGA	A	B	S	GR/MT	CANALINI BASE LARGA	A	B	S	GR/MT
CL 25x14x2,5	25	14	2,5	324	CL 30x25x5	30	25	5	945
CL 25x15x1,5	25	15	1,5	210	CL 31,2x28,5x2,5	31,2	28,5	2,5	562
CL 25x15x2	25	15	2	275	CL 32x15x1,5	32	15	1,5	237
CL 25x15x3	25	15	3	301	CL 33x15x1,2	33	15	1,2	196
CL 25x15x15	25	15	15	1013	CL 33x23x1,5	33	23	1,5	308
CL 25x16x2	25	16	2	286	CL 33x25x1,5	33	25	1,5	324
CL 25x16,6x1,1	25	16,6	1,1	192	CL 33,1x3,8x1,3	33,1	3,8	1,3	~170
CL 25x18x1	25	18	1	159	CL 33,6x28,3x1,3	33,6	28,3	1,3	308
CL 25x18x3	25	18	3	~490	CL 34x29x3	34	29	3	696
CL 25x19x1	25	19	1	164	CL 34x32x2	34	32	2	507
CL 25x20x1	25	20	1	170	CL 34,5x32,5x2	34,5	32,5	2	516
CL 25x20x1,5	25	20	1,5	251	CL 35x2,5x2,5	35	2,5	2,5	236
CL 25x20x2	25	20	2	330	CL 35x10x1,5	35	10	1,5	206
CL 25x20x2,5	25	20	2,5	405	CL 35x10x2	35	10	2	275
CL 25x20x3	25	20	3	477	CL 35x11x1,5	35	11	1,5	219
CL 26x17,5x1	26	17,5	1	159	CL 35x12x1,5	35	12	1,5	227
CL 26x20x2	26	20	2	327	CL 35x12x2	35	12	2	297
CL 27,8x10x1,2	27,8	10	1,2	147	CL 35x15x1,5	35	15	1,5	251
CL 28x12x2	28	12	2	254	CL 35x15x2	35	15	2	329
CL 28x12,5x1,3	28	12,5	1,3	230	CL 35x15x3	35	15	3	478
CL 28x15x1,3	28	15	1,3	194	CL 35x16x3	35	16	3	494
CL 28x20x1,5	28	20	1,5	263	CL 35x17x1	35	17	1	180
CL 28x20x2	28	20	2	346	CL 35x17x2	35	17	2	340
CL 28,4x20x1,5	28,4	20	1,5	265	CL 35x20x1,2	35	20	1,2	235
CL 29x15x2	29	15	2	297	CL 35x20x2	35	20	2	383
CL 29,8x8x1,3	29,8	8	1,3	140	CL 35x22x2	35	22	2	405
CL 30x6x2	30	6	2	205	CL 35x22,8x2,2	35	22,8	2,2	452
CL 30x7x1	30	7	1	113	CL 35x25x2	35	25	2	438
CL 30x10x1	30	10	1	124	CL 35x25x3	35	25	3	640
CL 30x10x1,5	30	10	1,5	190	CL 35x30x1,5	35	30	1,5	373
CL 30x10x2	30	10	2	248	CL 35x30x4	35	30	4	939
CL 30x10x3	30	10	3	360	CL 35x32,5x2,5	35	32,5	2,5	675
CL 30x12x2	30	12	2	270	CL 35x40x4	35	40	4	1155
CL 30x15x1	30	15	1	119	CL 35,4x20x1,5	35,4	20	1,5	293
CL 30x15x1,5	30	15	1,5	231	CL 37x20x2	37	20	2	394
CL 30x15x2	30	15	2	302	CL 38x20x1,5	38	20	1,5	304
CL 30x15x3	30	15	3	438	CL 38x25x2	38	25	2	453
CL 30x16x2,5	30	16	2,5	385	CL 38,5x27x1,3	38,5	27	1,3	275
CL 30x19x1	30	19	1	178	CL 40x10x2	40	10	2	302
CL 30x20x1,5	30	20	1,5	271	CL 40x10x3	40	10	3	437
CL 30x20x2	30	20	2	357	CL 40x12x2	40	12	2	324
CL 30x20x3	30	20	3	518	CL 40x15x1,5	40	15	1,5	272
CL 30x20x4	30	20	4	669	CL 40x15x2	40	15	2	356
CL 30x25x1,2	30	25	1,2	251	CL 40x15x3	40	15	3	542
CL 30x25x1,3	30	25	1,3	290	CL 40x15x5	40	15	5	811
CL 30x25x2	30	25	2	410	CL 40x16x6	40	16	6	970
CL 30x25x4	30	25	4	777	CL 40x17,5x2	40	17,5	2	381

\* Unless otherwise indicated, profiles are made of EN AW-6060T6 alloy

\* All dimensions are expressed in mm

Via Newton, n.12

20016 Pero (Milano - Italy)

Tel. +39 02 3535955 r.a. Fax. +39 02 3539929

E-Mail: [info@omar-alluminio.it](mailto:info@omar-alluminio.it)

Cataloghi Online: [www.omar-alluminio.it](http://www.omar-alluminio.it)

[www.omar-alluminio.com](http://www.omar-alluminio.com)

CUSTOM ALUMINUM PROFILES / STANDARD / SPECIAL / AND FOR:

ELECTRONICS / LED / PHOTOVOLTAIC / ROBOTIC AUTOMATION / PNEUMATICS / AUTOMOTIVE

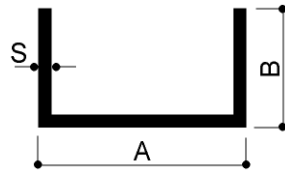

For more dimensions of aluminum channels, visit the site:

[www.canalini-alluminio.it](http://www.canalini-alluminio.it)

## WIDE BASE CHANNELS

CANALINI BASE LARGA	A	B	S	GR/MT	CANALINI BASE LARGA	A	B	S	GR/MT
CL 40x18x2	40	18	2	390	CL 45x32x2	45	32	2	567
CL 40x20x1,5	40	20	1,5	311	CL 45x35x5	45	35	5	1418
CL 40x20x2	40	20	2	410	CL 45x40x1,1	45	40	1,1	365
CL 40x20x2,5	40	20	2,5	506	CL 45x40x5	45	40	5	1553
CL 40x20x3	40	20	3	599	CL 45,4x30x2	45,4	30	2	548
CL 40x20x4	40	20	4	778	CL 45,5x12x2,5	45,5	12	2,5	435
CL 40x20x4,5	40	20	4,5	824	CL 46x15x2	46	15	2	389
CL 40x25x1,2	40	25	1,2	330	CL 46x24x3	46	24	3	713
CL 40x25x2	40	25	2	464	CL 47x20x2	47	20	2	449
CL 40x25x2,5	40	25	2,5	574	CL 48x20x1,5	48	20	1,5	346
CL 40x25x3	40	25	3	680	CL 48x20x2	48	20	2	454
CL 40x25x4	40	25	4	886	CL 48x20x3	48	20	3	~480
CL 40x26x2,5	40	26	2,5	~620	CL 48x22x2	48	22	2	~490
CL 40x27x4	40	27	4	928	CL 48x28x1,3	48	28	1,3	356
CL 40x30x1,5	40	30	1,5	191	CL 48x37x2	48	37	2	637
CL 40x30x2	40	30	2	518	CL 48,5x18,5x1,5	48,5	18,5	1,5	335
CL 40x30x2,8	40	30	2,8	712	CL 48,6x38x4	48,6	38	4	1242
CL 40x30x3	40	30	3	761	CL 49x30x1	49	30	1	289
CL 40x30x4	40	30	4	993	CL 49,75x31x4	49,75	31	4	1120
CL 40x30x5	40	30	5	1215	CL 50x10x2	50	10	2	356
CL 40x35x1,5	40	35	1,5	430	CL 50x15x1,5	50	15	1,5	312
CL 40x35x2	40	35	2	572	CL 50x15x2	50	15	2	410
CL 40x35x5	40	35	5	1384	CL 50x15x3	50	15	3	599
CL 40,2x8,5x1,5	40,2	8,5	1,5	219	CL 50x17x1,2	50	17	1,2	264
CL 40,2x15x2	40,2	15	2	273	CL 50x20x1,5	50	20	1,5	352
CL 40,5x35x3	40,5	35	3	850	CL 50x20x2	50	20	2	464
CL 41,8x26x1,4	41,8	26	1,4	354	CL 50x20x2,5	50	20	2,5	574
CL 42x8x3	42	8	3	420	CL 50x20x3	50	20	3	680
CL 42x30x1,5	42	30	1,5	403	CL 50x20x4	50	20	4	930
CL 43x27x2	43	27	2	502	CL 50x20x5	50	20	5	1080
CL 43x31,5x1,3	43	31,5	1,3	363	CL 50x25x1,5	50	25	1,5	393
CL 43,2x20x1,25	43,2	20	1,25	~330	CL 50x25x1,7	50	25	1,7	445
CL 43,4x20x1,2	43,4	20	1,2	262	CL 50x25x2	50	25	2	519
CL 43,4x40x1,2	43,4	40	1,2	392	CL 50x25x2,5	50	25	2,5	642
CL 43,5x30x1,5	43,5	30	1,5	408	CL 50x25x3	50	25	3	761
CL 43,7x30x1,6	43,7	30	1,6	434	CL 50x25x4	50	25	4	994
CL 43,8x30x1,2	43,8	30	1,2	328	CL 50x30x1,5	50	30	1,5	433
CL 44x40x2,5	44	40	2,5	803	CL 50x30x2	50	30	2	572
CL 45x15x2	45	15	2	383	CL 50x30x2,5	50	30	2,5	709
CL 45x20x1,5	45	20	1,5	332	CL 50x30x3	50	30	3	842
CL 45x20x2	45	20	2	437	CL 50x30x4	50	30	4	1101
CL 45x20x3	45	20	3	640	CL 50x30x5	50	30	5	1370
CL 45x25x1,5	45	25	1,5	372	CL 50x35x1,5	50	35	1,5	474
CL 45x25x2,5	45	25	2,5	608	CL 50x35x4,5	50	35	4,5	1349
CL 45x25x3	45	25	3	721	CL 50x38x5	50	38	5	1571
CL 45x30x1,5	45	30	1,5	413	CL 50x40x1,5	50	40	1,5	516
CL 45x30x2	45	30	2	545	CL 50x40x2	50	40	2	680

\* Unless otherwise indicated, profiles are made of EN AW-6060T6 alloy

\* All dimensions are expressed in mm

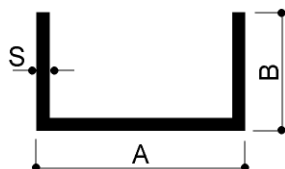

For more dimensions of aluminum channels,  
visit the site:

[www.canalini-alluminio.it](http://www.canalini-alluminio.it)

## WIDE BASE CHANNELS

CANALINI BASE LARGA	A	B	S	GR/MT	CANALINI BASE LARGA	A	B	S	GR/MT
CL 50x40x3	50	40	3	1004	CL 59x50x3	59	50	3	1240
CL 50x40x4	50	40	4	1318	CL 60x15x1,5	60	15	1,5	352
CL 50x40x5	50	40	5	1620	CL 60x15x2	60	15	2	464
CL 50x45x2	50	45	2	734	CL 60x15x3	60	15	3	680
CL 50x45x4	50	45	4	1426	CL 60x20x1,5	60	20	1,5	394
CL 50x45x5	50	45	5	1755	CL 60x20x2	60	20	2	518
CL 50,2x50x5	50,2	50	5	~1620	CL 60x20x4	60	20	4	1094
CL 51x25x1,3	51	25	1,3	364	CL 60x20x6	60	20	6	1814
CL 51x50x2	51	50	2	795	CL 60x20x8	60	20	8	1814
CL 51,8x30x1,3	51,8	30	1,3	383	CL 60x25x2	60	25	2	572
CL 52x25x1,2	52	25	1,2	323	CL 60x25x2,5	60	25	2,5	708
CL 52x25x1,3	52	25	1,3	348	CL 60x30x1,5	60	30	1,5	474
CL 52,4x31,2x1,2	52,4	31,2	1,2	361	CL 60x30x2	60	30	2	626
CL 53x25x1,3	53	25	1,3	354	CL 60x30x3	60	30	3	923
CL 53x45x1,5	53	45	1,5	567	CL 60x30x4	60	30	4	1209
CL 53,5x25x3	53,5	25	3	~830	CL 60x30x5	60	30	5	1750
CL 54x15x2	54	15	2	432	CL 60x30x6	60	30	6	1751
CL 54x19x2,5	54	19	2,5	450	CL 60x30x10	60	30	10	2700
CL 54x45x1,4	54	45	1,4	548	CL 60x35x3	60	35	3	1620
CL 54,5x27x1,3	54,5	27	1,3	373	CL 60x35x5	60	35	5	1620
CL 54,5x27x1,7	54,5	27	1,7	485	CL 60x40x2	60	40	2	734
CL 55x10,5x2,5	55	10,5	2,5	478	CL 60x40x2,5	60	40	2,5	911
CL 55x15x1,5	55	15	1,5	332	CL 60x40x3	60	40	3	1086
CL 55x17x1,5	55	17	1,5	348	CL 60x40x4	60	40	4	1425
CL 55x17x2	55	17	2	459	CL 60x40x5	60	40	5	2000
CL 55x20x2	55	20	2	491	CL 60x40x6	60	40	6	2074
CL 55x21x1,5	55	21	1,5	381	CL 60x45x5	60	45	5	1900
CL 55x25x1,2	55	25	1,2	332	CL 60x50x2	60	50	2	842
CL 55x25x2	55	25	2	545	CL 60x50x3	60	50	3	1247
CL 55x26x1	55	26	1	339	CL 60x50x5	60	50	5	2025
CL 55x26x1,2	55	26	1,2	339	CL 61x40x5	61	40	5	~1890
CL 55x26x1,5	55	26	1,5	421	CL 62,8x24x1,7	62,8	24	1,7	493
CL 55x27x1,7	55	27	1,7	497	CL 63x40x4	63	40	4	~1900
CL 55x30x1,5	55	30	1,5	453	CL 63x50x5	63	50	5	2078
CL 55x30x2	55	30	2	599	CL 64x40x1,5	64	40	1,5	571
CL 55x40x1,5	55	40	1,5	535	CL 64,5x30x1,5	64,5	30	1,5	492
CL 55x40x2	55	40	2	707	CL 65x15x2	65	15	2	492
CL 55x40x5	55	40	5	1688	CL 65x20x3	65	20	3	802
CL 55x50x1,5	55	50	1,5	616	CL 65x25x1,2	65	25	1,2	365
CL 55x50x1,7	55	50	1,7	695	CL 65x25x1,5	65	25	1,5	358
CL 55x50x2	55	50	2	815	CL 65x25x2	65	25	2	572
CL 56x30x2,5	56	30	2,5	749	CL 65x25x2,5	65	25	2,5	743
CL 56x40x1,3	56	40	1,3	468	CL 65x30x1,7	65	30	1,7	558
CL 56x40x2,5	56	40	2,5	884	CL 65x30x4	65	30	4	1250
CL 57x20x2	57	20	2	503	CL 65x40x4	65	40	4	1480
CL 58x35x3	58	35	3	990	CL 65x45x10	65	45	10	3672
CL 58x35x4	58	35	4	1300	CL 65x50x2	65	50	2	870

\* Unless otherwise indicated, profiles are made of EN AW-6060T6 alloy

\* All dimensions are expressed in mm

Via Newton, n.12

20016 Pero (Milano - Italy)

Tel. +39 02 3535955 r.a. Fax. +39 02 3539929

E-Mail: info@omar-alluminio.it

Cataloghi Online: [www.omar-alluminio.it](http://www.omar-alluminio.it)

[www.omar-alluminio.com](http://www.omar-alluminio.com)

CUSTOM ALUMINUM PROFILES / STANDARD / SPECIAL / AND FOR:

ELECTRONICS / LED / PHOTOVOLTAIC / ROBOTIC AUTOMATION / PNEUMATICS / AUTOMOTIVE

**OMAR** s.r.l.  
PROFILATI ALLUMINIO  
ALTA TECNOLOGIA



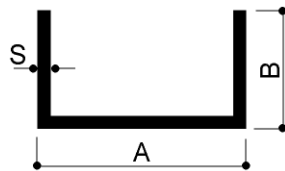

For more dimensions of aluminum channels,  
visit the site:

[www.canalini-alluminio.it](http://www.canalini-alluminio.it)

## WIDE BASE CHANNELS

CANALINI BASE LARGA	A	B	S	GR/MT	CANALINI BASE LARGA	A	B	S	GR/MT
CL 65x50x7	65	50	7	2857	CL 80x20x1,8	80	20	1,8	565
CL 65x55x2,5	65	55	2,5	1148	CL 80x20x2	80	20	2	627
CL 66x15x5	66	15	2	1161	CL 80x20x3	80	20	3	923
CL 66x20x2,5	66	20	2,5	682	CL 80x20x4	80	20	4	1209
CL 66x25x2,5	66	25	2,5	749	CL 80x20x6	80	20	6	1460
CL 66x80x2	66	80	2	1198	CL 80x25x2	80	25	2	680
CL 66,5x30x2	66,5	30	2	651	CL 80x25x4	80	25	4	1318
CL 68x55x4	68	55	4	1836	CL 80x30x3	80	30	3	1085
CL 68,5x50x3	68,5	50	3	1316	CL 80x30x3,5	80	30	3,5	1257
CL 69x50x3	69	50	3	1320	CL 80x30x5	80	30	5	1755
CL 70x10x1,5	70	10	1,5	353	CL 80x30x6	80	30	6	~2260
CL 70x15x1,5	70	15	1,5	393	CL 80x35x2	80	35	2	788
CL 70x15x2	70	15	2	518	CL 80x35x3	80	35	3	1166
CL 70x15x2,5	70	15	2,5	641	CL 80x40x2	80	40	2	842
CL 70x20x1,5	70	20	1,5	433	CL 80x40x2,5	80	40	2,5	1048
CL 70x20x2	70	20	2	572	CL 80x40x3	80	40	3	1247
CL 70x25x2	70	25	2	626	CL 80x40x4	80	40	4	1642
CL 70x25x2,5	70	25	2,5	776	CL 80x40x5	80	40	5	2045
CL 70x30x2	70	30	2	680	CL 80x40x6	80	40	6	2395
CL 70x30x3	70	30	3	1004	CL 80x45x3	80	45	3	1328
CL 70x30x4	70	30	4	1317	CL 80x45x5	80	45	5	2160
CL 70x30x6	70	30	6	~2100	CL 80x45x6	80	45	6	2560
CL 70x40x2	70	40	2	788	CL 80x45x6,5	80	45	6,5	2755
CL 70x40x2,5	70	40	2,5	979	CL 80x50x2	80	50	2	951
CL 70x40x3	70	40	3	1166	CL 80x50x3	80	50	3	1409
CL 70x40x4	70	40	4	1533	CL 80x50x4	80	50	4	1858
CL 70x40x5	70	40	5	1890	CL 80x50x5	80	50	5	2295
CL 70x40x6	70	40	6	2236	CL 80x50x6	80	50	6	2722
CL 70x40x7	70	40	7	2570	CL 80x60x2	80	60	2	1058
CL 70x50x8	70	50	8	3326	CL 80x60x5	80	60	5	2565
CL 70x60x3	70	60	3	1490	CL 80x60x8	80	60	8	3980
CL 70x68x4,8	70	68	4,8	2545	CL 80x60x8x5	80	60	5	2560
CL 73,5x21,2x1,2	73,5	21,2	1,2	400	CL 82x40x2	82	40	2	855
CL 74x28x2,5	74	28	2,5	844	CL 82x50x1,8	82	50	1,8	867
CL 74,8x54,8x8	74,8	54,8	8	3650	CL 83,5x20x2	83,5	20	2	645
CL 74,8x54,8x10	74,8	54,8	10	4461	CL 84x20x1,8	84	20	1,8	584
CL 75x40x4/5	75	40	4 e 5	1782	CL 84x20x2	84	20	2	650
CL 75x40x5	75	40	5	1958	CL 84x30x2	84	30	2	~720
CL 75,5x25x2,5	75,5	25	2,5	813	CL 84x32x2	84	32	2	778
CL 79x59x16	79	59	16	7128	CL 85x40x3	85	40	3	1288
CL 79,6x28x1,5	79,6	28	1,5	516	CL 85x50x2	85	50	2	980
CL 80x8x1	80	8	1	253	CL 85x50x4	85	50	4	1712
CL 80x10x2	80	10	2	518	CL 85x50x12	85	50	12	5213
CL 80x15x1,5	80	15	1,5	473	CL 85x65x3	85	65	3	1696
CL 80x15x2	80	15	2	572	CL 85,5x40x2,7	85,5	40	2,7	1167
CL 80x15x4	80	15	4	1026	CL 86x40x2,5	86	40	2,5	1087
CL 80x20x1,5	80	20	1,5	473	CL 86x40x3	86	40	3	1296

\* Unless otherwise indicated, profiles are made of EN AW-6060T6 alloy

\* All dimensions are expressed in mm



For more dimensions of aluminum channels, visit the site:

[www.canalini-alluminio.it](http://www.canalini-alluminio.it)

## WIDE BASE CHANNELS

CANALINI BASE LARGA	A	B	S	GR/MT	CANALINI BASE LARGA	A	B	S	GR/MT
CL 87x20x2	87	20	2	665	CL 100x60x10	100	60	10	5400
CL 88x50x3	86	50	3	1474	CL 100x65x8	100	65	8	4730
CL 90x15x2	90	15	2	556	CL 100x70x4	100	70	4	2506
CL 90x40x3	90	40	3	1329	CL 100x70x6	100	70	6	3694
CL 90x45x2,5	90	45	2,5	1203	CL 100x75x6	100	75	6	3855
CL 90x45x4	90	45	4	1858	CL 100x75x5	100	75	5	3240
CL 90x50x3	90	50	3	1491	CL 100x90x3	100	90	3	1247
CL 90x50x5	90	50	5	2430	CL 104x40x3	104	40	3	1442
CL 90x50x8	90	50	8	3758	CL 106x40x3	106	40	3	1458
CL 90x60x2	90	60	2	1150	CL 106x50x2	106	50	2	1101
CL 90x60x10	90	60	10	~5670	CL 107x50x1,5	107	50	1,5	~830
CL 91x30x2	91	30	2	794	CL 108x28x3	108	28	3	1280
CL 92x10x1,9	92	10	1,9	567	CL 108x50x3	108	50	3	1636
CL 94x60	94	60		5140	CL 108x60x5	108	60	5	2943
CL 94x70x6	94	70	6	~3700	CL 108x60x8	108	60	8	4580
CL 95x20x2	95	20	2	710	CL 108x60x8x5	108	60	8	3920
CL 95x60x10	95	60	10	5265	CL 110x20x2	110	20	2	788
CL 96x53x3	96	53	3	1581	CL 110x30x2	110	30	2	921
CL 98x25x1,2	98	25	1,2	472	CL 110x40x4	110	40	4	1965
CL 99,5x30x2	99,5	30	2	840	CL 113x60	113	60		6460
CL 100x10x1,5	100	10	1,5	445	CL 113x70	113	70		3973
CL 100x10x2	100	10	2	626	CL 120x15x2	120	15	2	788
CL 100x15x3,5	100	15	3,5	1161	CL 120x20x1,5	120	20	1,5	786
CL 100x20x1,5	100	20	1,5	554	CL 120x20x1,8	120	20	1,8	760
CL 100x20x2	100	20	2	735	CL 120x20x2	120	20	2	842
CL 100x20x3	100	20	3	1080	CL 120x20x2,5	120	20	2,5	1046
CL 100x25x2	100	25	2	788	CL 120x20x4	120	20	4	1641
CL 100x30x3	100	30	3	1244	CL 120x20x6	120	20	6	2398
CL 100x30x4	100	30	4	1642	CL 120x30x1,6	120	30	1,6	760
CL 100x37x8	100	37	8	2820	CL 120x30x1,7	120	30	1,7	810
CL 100x40x2	100	40	2	950	CL 120x30x1,8	120	30	1,8	838
CL 100x40x2,5	100	40	2,5	1181	CL 120x30x2	120	30	2	950
CL 100x40x3	100	40	3	1409	CL 120x30x4	120	30	4	1858
CL 100x40x4	100	40	4	1860	CL 120x40x3	120	40	3	1571
CL 100x40x5	100	40	5	2295	CL 120x40x4	120	40	4	2073
CL 100x45x5	100	45	5	2430	CL 120x40x5	120	40	5	2560
CL 100x50x3	100	50	3	1571	CL 120x45x2	120	45	2	1116
CL 100x50x4	100	50	4	2089	CL 120x45x10	120	45	10	5130
CL 100x50x5	100	50	5	3000	CL 120x50x5	120	50	5	2835
CL 100x50x6	100	50	6	3046	CL 120x50x12	120	50	12	635
CL 100x50x7	100	50	7	3515	CL 120x55x4	120	55	4	2398
CL 100x50x8	100	50	8	4003	CL 120x55x6	120	55	6	3532
CL 100x50x8,5	100	50	8,5	4200	CL 120x55x7	120	55	7	4150
CL 100x50x10	100	50	10	4860	CL 120x55x8	120	55	8	4660
CL 100x55x8	100	55	8	4187	CL 120x55x10	120	55	10	5670
CL 100x57,5x4	100	57,5	4	2235	CL 120x60x5	120	60	5	3410
CL 100x60x4	100	60	4	2290	CL 120x60x6	120	60	6	3888

\* Unless otherwise indicated, profiles are made of EN AW-6060T6 alloy

\* All dimensions are expressed in mm

Via Newton, n.12  
20016 Pero (Milano - Italy)  
Tel. +39 02 3535955 r.a. Fax. +39 02 3539929  
E-Mail: info@omar-alluminio.it

Cataloghi Online: [www.omar-alluminio.it](http://www.omar-alluminio.it)  
[www.omar-alluminio.com](http://www.omar-alluminio.com)

CUSTOM ALUMINIUM PROFILES / STANDARD / SPECIAL / AND FOR:  
ELECTRONICS / LED / PHOTOVOLTAIC / ROBOTIC AUTOMATION / PNEUMATICS / AUTOMOTIVE



For more dimensions of aluminum channels,  
visit the site:

[www.canalini-alluminio.it](http://www.canalini-alluminio.it)

## WIDE BASE CHANNELS

CANALINI BASE LARGA	A	B	S	GR/MT	CANALINI BASE LARGA	A	B	S	GR/MT
CL 120x60x9	120	60	9	5401	CL 160x50x5	160	50	5	3375
CL 120x60x10	120	60	10	5940	CL 160x60x10	160	60	10	7020
CL 120x60x7	120	60	7	4310	CL 160x60x12	160	60	12	8295
CL 120x60x8	120	60	8	4838	CL 160x65x7,5	160	65	7,5	6510
CL 120x80x8	120	80	8	5702	CL 160x80x5	160	80	5	4185
CL 122,2x15x2,5	122,2	15	2,5	993	CL 160x80x8	160	80	8	6641
CL 125x38x4,5	125	38	4,5	~2400	CL 160x80x10	160	80	10	8100
CL 125x50x2	125	50	2	1193	CL 160x100x10	160	100	10	9180
CL 125x63x6	125	63	6	3872	CL 160x120x8	160	120	8	8294
CL 125x80x8	125	80	8	5810	CL 165x25x2,5	165	25	2,5	1300
CL 128x65x13	128	65	13	7897	CL 170x80x10	170	80	10	8370
CL 130x30x2,5	130	30	2,5	~1100	CL 174x32x1,5	174	32	1,5	940
CL 130x90x4	130	90	4	~3300	CL 175x20x2	175	20	2	1126
CL 131,2x89,5x2	131,2	89,5	2	1653	CL 177,8x63,5x11,11x7,84	177,8	63,5	11,11	7290
CL 134x25x2	134	25	2	972	CL 180x25x5	180	25	5	2970
CL 135x25x2	135	25	2	977	CL 180x45x5	180	45	5	3510
CL 135x60x8	135	60	8	5162	CL 180x50x6	180	50	6	4342
CL 138x35x5	138	35	5	2673	CL 180x70	180	70		10350
CL 138x75	138	75		10006	CL 180x70x5	180	70	5	4185
CL 140x20x1,7	140	20	1,7	811	CL 180x75x2,5	180	75	2,5	2194
CL 140x30x5	140	30	5	2565	CL 180x75x4	180	75	4	3478
CL 140x35x4	140	35	4	2181	CL 180x80x8	180	80	8	6998
CL 140x40x6	140	40	6	3370	CL 180x100x8	180	100	8	7862
CL 140x50x5	140	50	5	3105	CL 200x20x2	200	20	2	1274
CL 140x50x6	140	50	6	~3800	CL 200x40x3	200	40	3	2219
CL 140x50x10	140	50	10	5940	CL 200x55x5	200	55	5	4050
CL 140x60	140	60		4085	CL 200x60x8	200	60	8	6570
CL 140x60x5	140	60	5	3375	CL 200x60x8x5	200	60	8	5190
CL 140x60x6	140	60	6	4018	CL 200x75x8	200	75	8	7214
CL 140x60x7	140	60	7	4650	CL 200x80	200	80		11700
CL 140x60x8	140	60	8	5270	CL 200x100x8	200	100	8	8470
CL 140x70	140	70		9820	CL 200x100x10	200	100	10	10260
CL 140x70x5	140	70	5	3645	CL 200x100x12	200	100	12	12300
CL 140x70x8	140	70	8	5820	CL 203,2x58,1x6,3	203,2	58,1	6,3	5260
CL 140x70x10	140	70	10	7020	CL 203,2x76,2x12,7x7,94	203,2	76,2	7,94	9260
CL 150x15x2	150	15	2	950	CL 220x120x10x15	220	120	10	14710
CL 150x30x2	150	30	2	1112	CL 225x100x10	225	100	10	10935
CL 150x30x3	150	30	3	1652	CL 228x76x12x9	228	76	12	10060
CL 150x37x3	150	37	3	1766	CL 228,6x88,9x12,7x9,5	228,6	88,9	12,7	11520
CL 150x38x2,5	150	38	2,5	1420	CL 240x50x8	240	50	8	6998
CL 150x40x4	150	40	4	2398	CL 250x100x12	250	100	12	13802
CL 150x50x3	150	50	3	1976	CL 254x88,9x14,28x11,11	254	88,9	14,28	13930
CL 150x50x5	150	50	5	3240	CL 270x60x9,9x6	270	60	9,9	7300
CL 150x75x8	150	75	8	6220	CL 300x75x10	300	75	10	11900
CL 150x100x4	150	100	4	3692	CL 300x80x15	300	80	15	17414
CL 150x100x6	150	100	6	5476	CL 305x86x20	305	86	20	21300
CL 155x25x3	155	25	3	1612	CL 370x75x12x8	370	75	12	12460

\* Unless otherwise indicated, profiles are made of EN AW-6060T6 alloy

\* All dimensions are expressed in mm

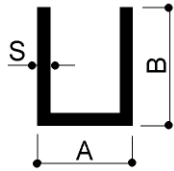

For more dimensions of aluminum channels, visit the site:

[www.canalini-alluminio.it](http://www.canalini-alluminio.it)

## NARROW BASE CHANNELS

CANALINI BASE STRETTA	A	B	S	GR/MT	CANALINI BASE STRETTA	A	B	S	GR/MT
CS 4x8x1	4	8	1	48	CS 11x32x2	11	32	2	384
CS 4,2x10x1,2	4,2	10	1,2	71	CS 11,5x30x1,75	11,5	30	1,75	321
CS 5x8x1	5	8	1	52	CS 11,7x13x1,8	11,7	13	1,8	165
CS 6x8x1	6	8	1	54	CS 12x13x2	12	13	2	184
CS 6x10x0,9	6	10	0,9	59	CS 12x15x1	12	15	1	108
CS 6x10,5x1,2	6	10,5	1,2	80	CS 12x15x1,2	12	15	1,2	128
CS 6x11x1	6	11	1	70	CS 12x15x1,5	12	15	1,5	158
CS 6x15x1,5	6	15	1,5	134	CS 12x15x2	12	15	2	205
CS 6,5x15x1	6,5	15	1	93	CS 12x16x1,5	12	16	1,5	166
CS 7x8x1,2	7	8	1,2	67	CS 12x20x1	12	20	1	135
CS 7x10x1,3	7	10	1,3	86	CS 12x20x1,2	12	20	1,2	161
CS 7x10x1,5	7	10	1,5	97	CS 12x20x1,5	12	20	1,5	198
CS 7x35x2	7	35	2	394	CS 12x20x2	12	20	2	259
CS 7,5x15x2	7,5	15	2	181	CS 12x25x2	12	25	2	460
CS 8x10x1,2	8	10	1,2	84	CS 12x32x1,5	12	32	1,5	296
CS 8x10x1,5	8	10	1,5	101	CS 12x35x2	12	35	2	421
CS 8x11x2	8	11	2	140	CS 12,5x25x2	12,5	25	2	316
CS 8x12x1	8	12	1	81	CS 12,8x20x1,4	12,8	20	1,4	192
CS 8x13x1	8	13	1	86	CS 13x15x1	13	15	1	111
CS 8x14x1,2	8	14	1,2	122	CS 13x15x1,5	13	15	1,5	162
CS 8x15x1	8	15	1	97	CS 13x16x2	13	16	2	221
CS 8x15x1,2	8	15	1,2	115	CS 13x18x1	13	18	1	127
CS 8x15x1,5	8	15	1,5	140	CS 13x18x1,5	13	18	1,5	186
CS 8x18x2	8	18	2	216	CS 13x18x2	13	18	2	216
CS 8,5x9x2,75	8,5	9	2,75	148	CS 13x20x1	13	20	1	138
CS 8,5x12x1,2	8,5	12	1,2	98	CS 13x20x1,2	13	20	1,2	164
CS 8,9x13x1,8	8,9	13	1,8	165	CS 13x20x1,5	13	20	1,5	203
CS 9x16x1,5	9	16	1,5	153	CS 13x25x1,25	13	25	1,25	204
CS 9,3x10x1,5	9,3	10	1,5	106	CS 14x16x2	14	16	2	227
CS 10x12x1,5	10	12	1,5	118	CS 14x18x2	14	18	2	248
CS 10x13x0,8	10	13	0,8	75	CS 14,2x30x1	14,2	30	1	194
CS 10x15x1	10	15	1	103	CS 14,5x20x1	14,5	20	1	140
CS 10x15x1,2	10	15	1,2	122	CS 15x17,5x2	15	17,5	2	248
CS 10x15x1,5	10	15	1,5	152	CS 15x20x1	15	20	1	143
CS 10x15x2	10	15	2	194	CS 15x20x1,2	15	20	1,2	170
CS 10x20x1	10	20	1	130	CS 15x20x1,5	15	20	1,5	211
CS 10x20x1,2	10	20	1,2	154	CS 15x20x1,8	15	20	1,8	150
CS 10x20x1,5	10	20	1,5	190	CS 15x20x2	15	20	2	275
CS 10x20x2	10	20	2	248	CS 15x25x1,25	15	25	1,25	211
CS 10x27x2	10	27	2	324	CS 15x25x2	15	25	2	329
CS 10x40x2	10	40	2	465	CS 15x30x1,2	15	30	1,2	235
CS 10,6x18x1,2	10,6	18	1,2	140	CS 15x30x1,5	15	30	1,5	292
CS 11x12x1,5	11	12	1,5	130	CS 15x30x2	15	30	2	385
CS 11x16x1,5	11	16	1,5	167	CS 15x31x1	15	31	1	~200
CS 11x20x1,25	11	20	1,25	164	CS 15x40x3	15	40	3	721
CS 11x25x1,5	11	25	1,5	235	CS 15x50x2	15	50	2	599

\* Unless otherwise indicated, profiles are made of EN AW-6060T6 alloy

\* All dimensions are expressed in mm

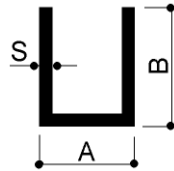

For more dimensions of aluminum channels, visit the site:

[www.canalini-alluminio.it](http://www.canalini-alluminio.it)

## NARROW BASE CHANNELS

CANALINI BASE STRETTA	A	B	S	GR/MT	CANALINI BASE STRETTA	A	B	S	GR/MT
CS 15,2x50x1,6	15,2	50	1,6	483	CS 20x27,5x2	20	27,5	2	383
CS 16x18x1,5	16	18	1,5	198	CS 20x28x1,2	20	28	1,2	238
CS 16x18x2	16	18	2	259	CS 20x28x1,5	20	28	1,5	295
CS 16x20x1,2	16	20	1,2	174	CS 20x30x1,5	20	30	1,5	312
CS 16x25x1,2	16	25	1,2	206	CS 20x30x2	20	30	2	410
CS 16x28x1,2	16	28	1,2	226	CS 20x35x1,5	20	35	1,5	352
CS 16x34x1	16	34	1	221	CS 20x35x2	20	35	2	464
CS 16x35x1,45	16	35	1,45	336	CS 20x37x3	20	37	3	713
CS 16x35x1,50	16	35	1,5	336	CS 20x40x1,5	20	40	1,5	393
CS 16x43x2	16	43	2	530	CS 20x40x2	20	40	2	518
CS 16,1x22,2x1	16,1	22,2	1	~230	CS 20x40x2,5	20	40	2,5	642
CS 16,3x34x1	16,3	34	1	222	CS 20x40x4	20	40	4	410
CS 16,5x30x1,5	16,5	30	1,5	298	CS 20x49x1,5	20	49	1,5	489
CS 17x20x1,2	17	20	1,2	177	CS 20x50x1,5	20	50	1,5	475
CS 17x20x1,5	17	20	1,5	219	CS 20x50x2	20	50	2	626
CS 17x25x1,2	17	25	1,2	209	CS 21x30x2	21	30	2	400
CS 17x25x1,5	17	25	1,5	259	CS 21x32x2	21	32	2	437
CS 17x28x1,2	17	28	1,2	229	CS 21,7x33,9x1,7	21,7	33,9	1,7	389
CS 17x30x2	17	30	2	394	CS 21,8x25x1,5	21,8	25	1,5	298
CS 17x32x1,5	17	32	1,5	319	CS 22x30x1,5	22	30	1,5	319
CS 17,2x35x1,1	17,2	35	1,1	248	CS 22x35x1,5	22	35	1,5	360
CS 17,5x28x1,2	17,5	28	1,2	230	CS 22,5x25x1,5	22,5	25	1,5	281
CS 17,67x20x0,8	17,7	20	0,8	122	CS 22,6x26x1	22,6	26	1	195
CS 18x20x1	18	20	1	151	CS 25x27x3	25	27	3	600
CS 18x20x1,2	18	20	1,2	180	CS 25x30x1,3	25	30	1,3	288
CS 18x20x1,5	18	20	1,5	223	CS 25x30x2	25	30	2	437
CS 18x22x1,5	18	22	1,5	239	CS 25x35x6	25	35	6	1342
CS 18x25x1,25	18	25	1,25	221	CS 25x40x3	25	40	3	802
CS 18x25x1,5	18	25	1,5	263	CS 25x50x2	25	50	2	653
CS 18x25x3	18	25	3	502	CS 26x35x5	26	35	5	1161
CS 18x28x1,2	18	28	1,2	232	CS 26x60x3	26	60	3	1145
CS 18x28x1,5	18	28	1,5	288	CS 28x40x2,2	28	40	2,2	615
CS 18,3x25x1	18,3	25	1	~200	CS 28x53x3	28	53	3	1040
CS 18,4x28x1	18,4	28	1	~220	CS 29x36x4	29	36	4	1004
CS 19x20x1	19	20	1	154	CS 30x35x1,5	30	35	1,5	393
CS 19x20x1,2	19	20	1,2	183	CS 30x40x3	30	40	3	842
CS 19x20x1,5	19	20	1,5	223	CS 30x40x4	30	40	4	1101
CS 19x25x1	19	25	1	181	CS 30x50x1,5	30	50	1,5	514
CS 19x25x1,2	19	25	1,2	216	CS 30x50x2	30	50	2	680
CS 19x28x1,5	19	28	1,5	292	CS 30x50x3	30	50	3	1004
CS 19x30x2	19	30	2	405	CS 30x50x4	30	50	4	1317
CS 20x25x1,2	20	25	1,2	219	CS 30x60x2,5	30	60	2,5	979
CS 20x25x1,25	20	25	1,25	272	CS 32,8x50x1,7	32,8	50	1,7	591
CS 20x25x1,5	20	25	1,5	272	CS 33,4x38x2,5	33,4	38	2,5	699
CS 20x25x2	20	25	2	356	CS 33,75x31x4	33,75	31	4	948
CS 20x25x3	20	25	3	518	CS 34,4x46x1,2	34,4	46	1,2	401

\* Unless otherwise indicated, profiles are made of EN AW-6060T6 alloy

\* All dimensions are expressed in mm



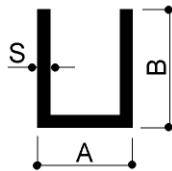

For more dimensions of aluminum channels,  
visit the site:

[www.canalini-alluminio.it](http://www.canalini-alluminio.it)

## NARROW BASE CHANNELS

CANALINI BASE STRETTA	A	B	S	GR/MT	CANALINI BASE STRETTA	A	B	S	GR/MT
CS 34,5x60x1,75	34,5	60	1,75	714	CS 45x60x2	45	60	2	869
CS 35x40x1,5	35	40	1,5	453	CS 46x50x1,5	46	50	1,5	579
CS 35x40x2	35	40	2	599	CS 46x50x3	46	50	3	1109
CS 35x50x2	35	50	2	707	CS 50x60x1,5	50	60	1,5	717
CS 35,1x41x2,5	35,1	41	2,5	756	CS 50x80x3	50	80	3	1652
CS 38x53x2	38	53	2	756	CS 52x60x3	52	60	3	1342
CS 40x50x1,3	40	50	1,3	450	CS 53x65x1,5	53	65	1,5	729
CS 40x50x2	40	50	2	735	CS 55x60x1,5	55	60	1,5	696
CS 40x50x3	40	50	3	1085	CS 55x65x2,5	55	65	2,5	1215
CS 40x50x4	40	50	4	1426	CS 55x70x1,5	55	70	1,5	778
CS 40x50x6	40	50	6	2037	CS 55x70x1,7	55	70	1,7	880
CS 40x60x1,4	40	60	1,4	610	CS 55x70x1,8	55	70	1,8	930
CS 40x60x2	40	60	2	842	CS 55x80x2	55	80	2	1139
CS 40x60x3	40	60	3	1248	CS 55x150x2	55	150	2	1893
CS 40x60x4	40	60	4	1642	CS 55,5x62,5x2,5	55,5	62,5	2,5	1185
CS 40x65x2	40	65	2	896	CS 56x70x1,7	56	70	1,7	885
CS 40x70x3	40	70	3	1409	CS 56x85x3	56	85	3	1782
CS 43x50x1,6	43	50	1,6	604	CS 56x102x2	56	102	2	1382
CS 43,5x50x1,5	43,5	50	1,5	570	CS 60x80x4,5	60	80	4,5	2562
CS 45x50x1,5	45	50	1,5	575	CS 100x200x9	100	200	9	11827
CS 45x50x5	45	50	5	1836	CS 150x208x6x15	150	208	15	12460

\* Unless otherwise indicated, profiles are made of EN AW-6060T6 alloy

\* All dimensions are expressed in mm



EXAMPLE PHOTO: CUTTING ALUMINIUM PROFILES EVEN OF LARGE DIMENSIONS

Via Newton, n.12

20016 Pero (Milano - Italy)

Tel. +39 02 3535955 r.a. Fax. +39 02 3539929

E-Mail: [info@omar-alluminio.it](mailto:info@omar-alluminio.it)

Cataloghi Online: [www.omar-alluminio.it](http://www.omar-alluminio.it)

[www.omar-alluminio.com](http://www.omar-alluminio.com)

CUSTOM ALUMINIUM PROFILES / STANDARD / SPECIAL / AND FOR:

ELECTRONICS / LED / PHOTOVOLTAIC / ROBOTIC AUTOMATION / PNEUMATICS / AUTOMOTIVE

**OMAR**  
s.r.l.  
PROFILATI ALLUMINIO  
ALTA TECNOLOGIA



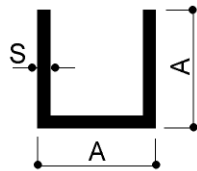

For more dimensions of aluminum channels, visit the site:

[www.canalini-alluminio.it](http://www.canalini-alluminio.it)

## EQUAL SIDED CHANNELS

CANALINI LATI UGUALI	A	S	GR/MT	CANALINI LATI UGUALI	A	S	GR/MT
CU 6x6x1	6	1	43	CU 30x30x1,2	30	1,2	283
CU 7x7x1	7	1	51	CU 30x30x2	30	2	464
CU 7x7x1,2	7	1,2	60	CU 30x30x2,5	30	2,5	570
CU 8x8x1	8	1	59	CU 30x30x3	30	3	680
CU 9x9x1	9	1	68	CU 30x30x3,5	30	3,5	784
CU 10x10x1	10	1	76	CU 30x30x4	30	4	890
CU 10x10x1,2	10	1,2	89	CU 30x30x5	30	5	1077
CU 10x10x1,25	10	1,25	93	CU 35x35x1,5	35	1,5	413
CU 10x10x1,5	10	1,5	108	CU 35x35x2	35	2	545
CU 10x10x2	10	2	140	CU 35x35x3	35	3	802
CU 11x11x1,5	11	1,5	122	CU 40x40x1,5	40	1,5	470
CU 12x12x1	12	1	92	CU 40x40x2	40	2	626
CU 12x12x1,2	12	1,2	109	CU 40x40x2,5	40	2,5	776
CU 12x12x1,3	12	1,3	117	CU 40x40x3	40	3	923
CU 12x12x1,5	12	1,5	134	CU 40x40x4	40	4	1209
CU 12x12x1,8	12	1,8	157	CU 40x40x5	40	5	1484
CU 12x12x2	12	2	173	CU 43,5x43,5x3	43,5	3	1000
CU 12,5x12,5x1,5	12,5	1,5	140	CU 45x45x1,5	45	1,5	534
CU 13x13x2	13	2	189	CU 45x45x2	45	2	710
CU 14x14x2	14	2	205	CU 45x45x2,5	45	2,5	878
CU 15x15x1	15	1	108	CU 45x45x3	45	3	1045
CU 15x15x1,2	15	1,2	138	CU 45x45x4	45	4	1372
CU 15x15x1,5	15	1,5	170	CU 50x50x1,5	50	1,5	595
CU 15x15x2	15	2	221	CU 50x50x2	50	2	788
CU 15x15x2,5	15	2,5	270	CU 50x50x3	50	3	1166
CU 18x18x2	18	2	270	CU 50x50x4	50	4	1533
CU 19x19x1,5	19	1,5	219	CU 50x50x4,5	50	4,5	1713
CU 19x19x3	19	3	410	CU 50x50x5	50	5	1890
CU 20x20x1	20	1	165	CU 50x50x6	50	6	2236
CU 20x20x1,2	20	1,2	186	CU 55x55x1,5	55	1,5	656
CU 20x20x1,5	20	1,5	231	CU 55x55x2	55	2	869
CU 20x20x1,7	20	1,7	259	CU 60x60x2	60	2	950
CU 20x20x2	20	2	302	CU 60x60x3	60	3	1409
CU 20x20x3	20	3	437	CU 60x60x4	60	4	1858
CU 22x22x2	22	2	335	CU 60x60x5	60	5	2295
CU 23x23x1,2	23	1,2	224	CU 65x65x1,8	65	1,8	912
CU 23x23x1,5	23	1,5	267	CU 70x70x2	70	2	1112
CU 23x23x1,9	23	1,9	334	CU 70x70x4	70	4	2182
CU 23x23x2,5	23	2,5	432	CU 70x70x10	70	10	5130
CU 25x25x1,3	25	1,3	254	CU 80x80x3	80	3	1895
CU 25x25x1,5	25	1,5	292	CU 80x80x4	80	4	2506
CU 25x25x2	25	2	384	CU 90x90x4	90	4	2832
CU 25x25x2,5	25	2,5	473	CU 100x100x2,3	100	2,3	1836
CU 25x25x3	25	3	559	CU 100x100x2,5	100	2,5	1991
CU 25x25x4	25	4	724	CU 100x100x7	100	7	5405

\* Unless otherwise indicated, profiles are made of EN AW-6060T6 alloy

\* All dimensions are expressed in mm

Via Newton, n. 12  
20016 Pero (Milano - Italy)  
Tel. +39 02 3535955 r.a. Fax. +39 02 3539929  
E-Mail: info@omar-alluminio.it

Cataloghi Online: [www.omar-alluminio.it](http://www.omar-alluminio.it)  
[www.omar-alluminio.com](http://www.omar-alluminio.com)

CUSTOM ALUMINIUM PROFILES / STANDARD / SPECIAL / AND FOR:  
ELECTRONICS / LED / PHOTOVOLTAIC / ROBOTIC AUTOMATION / PNEUMATICS / AUTOMOTIVE

**OMAR** s.p.a.  
PROFILATI ALLUMINIO  
ALTA TECNOLOGIA

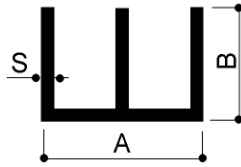

For more dimensions of aluminum channels, visit the site:

[www.canalini-alluminio.it](http://www.canalini-alluminio.it)

## DOUBLE CHANNELS

CANALINI DOPPI	A	B	S	GR/MT	CANALINI DOPPI	A	B	S	GR/MT
CD 11x6x1,2	11	6	1,2	82	CD 20x15x1,5	20	15	1,5	245
CD 12x8x1,2	12	8	1,2	105	CD 20x16x1	20	16	1	176
CD 14x7x1	14	7	1	90	CD 20x16x1,2	20	16	1,2	208
CD 14x7x1,2	14	7	1,2	102	CD 20x18x1	20	18	1	190
CD 14x12x1,2	16	12	1,2	150	CD 20x18x1,2	20	18	1,2	227
CD 16x7x1	16	7	1	92	CD 20x20x1	20	20	1	208
CD 16x7x1,2	16	7	1,2	108	CD 20x20x1,1	20	20	1,1	228
CD 16x12x1	16	12	1	140	CD 20x20x1,3	20	20	1,3	267
CD 16x12x1,2	16	12	1,2	157	CD 20,5x15	20,5	15		188
CD 16x14x1,3	16	14	1,3	190	CD 20,5x15,5x1,5	20,5	15,5	1,5	250
CD 17x10x1,2	17	10	1,2	141	CD 20,5x16x1,5	20,5	16	1,5	259
CD 18x8x1,2	18	8	1,2	124	CD 20,5x18x1,2	20,5	18	1,2	255
CD 18x15,5x1,3	18	15,5	1,3	220	CD 20,5x20x1,2	20,5	20	1,2	255
CD 20x8x1,2	20	8	1,2	131	CD 21x7x1,5	21	7	1,5	152
CD 20x10x1	20	10	1	135	CD 21x14X1	21	14	1	175
CD 20x10x1,2	20	10	1,2	180	CD 21x14x1,5	21	14	1,5	237
CD 20x10x1,5	20	10	1,5	151	CD 21x16x1,2	21	16	1,2	212
CD 20x11x1,2	20	11	1,2	160	CD 21x16x1,5	21	16	1,5	261
CD 20x12x1,2	20	12	1,2	170	CD 24x12x1,3	24	12	1,3	197
CD 20x15x1	20	15	1	167	CD 24,5x16x1,5	24,5	16	1,5	275

\* Unless otherwise indicated, profiles are made of EN AW-6060T6 alloy

\* All dimensions are expressed in mm



EXAMPLE PHOTO: ALUMINUM PROFILES FOR STADIE STAGGIE

Via Newton, n.12

20016 Pero (Milano - Italy)

Tel. +39 02 3535955 r.a. Fax. +39 02 3539929

E-Mail: [info@omar-alluminio.it](mailto:info@omar-alluminio.it)

Cataloghi Online: [www.omar-alluminio.it](http://www.omar-alluminio.it)

[www.omar-alluminio.com](http://www.omar-alluminio.com)

CUSTOM ALUMINUM PROFILES / STANDARD / SPECIAL / AND FOR:

ELECTRONICS / LED / PHOTOVOLTAIC / ROBOTIC AUTOMATION / PNEUMATICS / AUTOMOTIVE

**OMAR**  
s.r.l.  
PROFILATI ALLUMINIO  
ALTA TECNOLOGIA





Via Newton, n. 12  
20016 Pero (Milano - Italy)  
Tel. +39 02 3535955 r.a. Fax. +39 02 3539929  
E. Mail: info@omar-alluminio.it

Cataloghi Online: [www.omar-alluminio.it](http://www.omar-alluminio.it)  
[www.omar-alluminio.com](http://www.omar-alluminio.com)

CUSTOM ALUMINIUM PROFILES / STANDARD / SPECIAL / AND FOR:

ELECTRONICS / LED / PHOTOVOLTAIC / ROBOTIC AUTOMATION / PNEUMATICS / AUTOMOTIVE

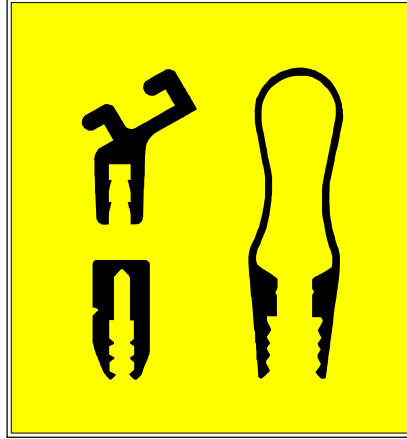

Pdf catalog of squeegee door profiles:  
[www.serigrafia.sm](http://www.serigrafia.sm)

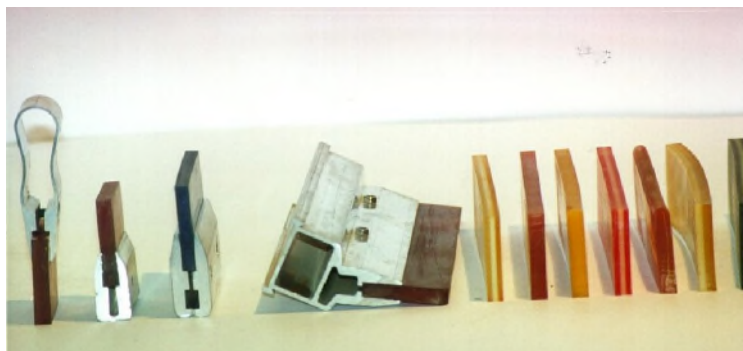
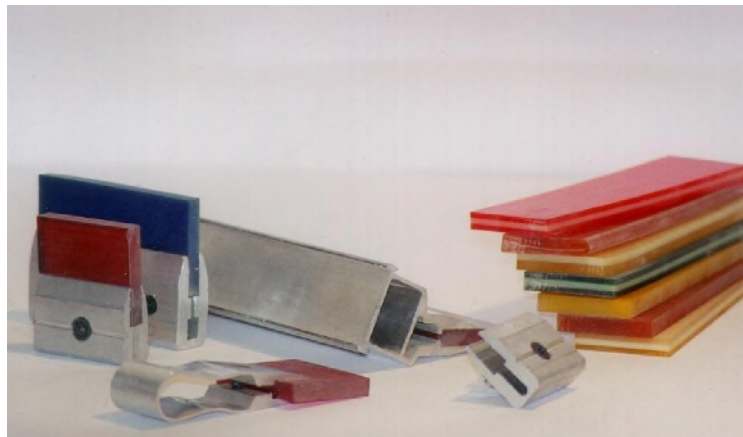

EXAMPLE PHOTO: EXTRUDED ALUMINIUM PROFILES FOR  
DOCTOR BLADES - MECHANICAL - HAND

FOLLOWS: CATALOGUE OF CORNER PROFILES / 'L' PROFILES

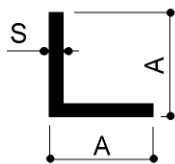

For more dimensions of aluminum angles consult the site:

[www.angolari-alluminio.it](http://www.angolari-alluminio.it)

## CORNERS

ANGOLARI	A	S	GR/MT	ANGOLARI	A	S	GR/MT
L 7,5x7,5x1	7,5	1	37	L 25x25x3	25	3	381
L 10x10x1	10	1	51	L 25x25x3,5	25	3,5	440
L 10x10x1,2	10	1,2	61	L 25x25x4	25	4	497
L 10x10x1,5	10	1,5	75	L 25x25x5	25	5	607
L 10x10x2	10	2	97	L 25,4x25,4x1,6	25,4	1,6	213
L 12x12x1	12	1	62	L 29x29x4	29	4	584
L 12x12x1,5	12	1,5	92	L 30x30x1	30	1	159
L 12x12x2	12	2	119	L 30x30x1,5	30	1,5	237
L 12x12x3	12	3	170	L 30x30x1,8	30	1,8	283
L 14x14x3	14	3	202	L 30x30x2	30	2	313
L 15x15x1	15	1	78	L 30x30x2,5	30	2,5	388
L 15x15x1,5	15	1,5	115	L 30x30x2,7	30	2,7	418
L 15x15x1,6	15	1,6	123	L 30x30x3	30	3	461
L 15x15x2	15	2	151	L 30x30x4	30	4	605
L 15x15x2,5	15	2,5	191	L 30x30x5	30	5	743
L 15x15x3	15	3	219	L 30x30x6	30	6	~900
L 16x16x2	16	2	162	L 30x30x6,8	30	6,8	976
L 17,75x17,75x1,5	17,75	1,5	138	L 30x30x10	30	10	1350
L 18x18x1,3	18	1,3	121	L 32x32x2	32	2	335
L 18x18x2	18	2	184	L 32x32x2,5	32	2,5	~450
L 18x18x2,5	18	2,5	226	L 35x35x1,5	35	1,5	277
L 18x18x3	18	3	268	L 35x35x2	35	2	367
L 19x19x2	19	2	194	L 35x35x2,5	35	2,5	455
L 19,5x19,5x1,5	19,5	1,5	151	L 35x35x2,7	35	2,7	491
L 20x20x1	20	1	105	L 35x35x3	35	3	543
L 20x20x1,3	20	1,3	136	L 35x35x4	35	4	713
L 20x20x1,5	20	1,5	156	L 35x35x5	35	5	877
L 20x20x1,7	20	1,7	176	L 35x35x9	35	9	1482
L 20x20x1,8	20	1,8	185	L 38x38x4	38	4	777
L 20x20x2	20	2	205	L 40x40x1	40	1	214
L 20x20x2,5	20	2,5	253	L 40x40x1,1	40	1,1	235
L 20x20x3	20	3	300	L 40x40x1,5	40	1,5	318
L 20x20x4	20	4	389	L 40x40x1,8	40	1,8	381
L 20x20x5	20	5	472	L 40x40x2	40	2	421
L 21x21x1	21	1	110	L 40x40x2,5	40	2,5	523
L 23x23x2	23	2	238	L 40x40x3	40	3	624
L 23x23x3	23	3	348	L 40x40x3,2	40	3,2	~650
L 23,5x23,5x1,5	23,5	1,5	184	L 40x40x3,6	40	3,6	743
L 24x24x2,5	24	2,5	307	L 40x40x3,9	40	3,9	801
L 25x25x1	25	1	132	L 40x40x4	40	4	821
L 25x25x1,2	25	1,2	159	L 40x40x5	40	5	1012
L 25x25x1,3	25	1,3	151	L 40x40x6	40	6	1199
L 25x25x1,5	25	1,5	196	L 43x43x2	43	2	454
L 25x25x1,8	25	1,8	235	L 43x43x3	43	3	551
L 25x25x2	25	2	259	L 45x45x1,6	45	1,6	382
L 25x25x2,5	25	2,5	321	L 45x45x2	45	2	475
L 25x25x2,7	25	2,7	345	L 45x45x2,5	45	2,5	590

\* Unless otherwise indicated, profiles are made of EN AW-6060T6 alloy

\* All dimensions are expressed in mm

Via Newton, n.12  
20016 Pero (Milano - Italy)  
Tel. +39 02 3535955 r.a. Fax. +39 02 3539929  
E-Mail: [info@omar-alluminio.it](mailto:info@omar-alluminio.it)

Cataloghi Online: [www.omar-alluminio.it](http://www.omar-alluminio.it)  
[www.omar-alluminio.com](http://www.omar-alluminio.com)

CUSTOM ALUMINIUM PROFILES / STANDARD / SPECIAL / AND FOR:  
ELECTRONICS / LED / PHOTOVOLTAIC / ROBOTIC AUTOMATION / PNEUMATICS / AUTOMOTIVE



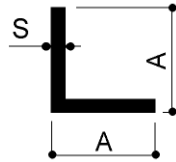

For more dimensions of aluminum angles  
consult the site:

[www.angolari-alluminio.it](http://www.angolari-alluminio.it)

## CORNERS

ANGOLARI	A	S	GR/MT	ANGOLARI	A	S	GR/MT
L 45x45x3	45	3	705	L 75x75x5	75	5	1958
L 45x45x4	45	4	929	L 75x75x8	75	8	3067
L 45x45x5	45	5	1147	L 75x75x10	75	10	3780
L 45x45x6	45	6	1358	L 76x76x6	76	6	2360
L 45x45x8	45	8	1778	L 80x80x2	80	2	855
L 47x47x2	47	2	486	L 80x80x2,5	80	2,5	1063
L 50x50x1	50	1	267	L 80x80x3	80	3	1282
L 50x50x1,5	50	1,5	399	L 80x80x4	80	4	1685
L 50x50x2	50	2	529	L 80x80x5	80	5	2082
L 50x50x2,7	50	2,7	709	L 80x80x6	80	6	2495
L 50x50x3	50	3	786	L 80x80x6,3	80	6,3	~2500
L 50x50x4	50	4	1037	L 80x80x6,5	80	6,5	2693
L 50x50x5	50	5	1282	L 80x80x8	80	8	3283
L 50x50x6	50	6	1523	L 80x80x10	80	10	4050
L 50x50x7	50	7	1758	L 80x80x12	80	12	4813
L 50x50x8	50	8	1987	L 90x90x6	90	6	2819
L 50x50x10	50	10	2430	L 90x90x8	90	8	3720
L 55x55x3	55	3	865	L 90x90x10	90	10	4590
L 60x60x1,7	60	1,7	543	L 90x90x11	90	11	5019
L 60x60x1,8	60	1,8	575	L 95x95x5	95	5	2497
L 60x60x2	60	2	637	L 100x100x2	100	2	1077
L 60x60x2,5	60	2,5	793	L 100x100x3	100	3	1596
L 60x60x3	60	3	948	L 100x100x4	100	4	2117
L 60x60x4	60	4	1253	L 100x100x5	100	5	2632
L 60x60x5	60	5	1620	L 100x100x6	100	6	3143
L 60x60x6	60	6	1847	L 100x100x8	100	8	4147
L 60x60x8	60	8	2420	L 100x100x9	100	9	4641
L 60x60x10	60	10	2970	L 100x100x9,9	100	9,9	5081
L 60x60x13,5	60	13,5	3882	L 100x100x10	100	10	5130
L 63x63x6,3	63	6,3	~1900	L 100x100x12	100	12	6091
L 65x65x5	65	5	1685	L 100x100x15	100	15	7493
L 65x65x7	65	7	2325	L 110x110x6	110	6	3467
L 65x65x8	65	8	2635	L 120x120x3	120	3	1920
L 70x70x2	70	2	745	L 120x120x8	120	8	5011
L 70x70x2,5	70	2,5	928	L 120x120x10	120	10	6210
L 70x70x3	70	3	1110	L 120x120x11	120	11	6801
L 70x70x4	70	4	1469	L 120x120x12	120	12	7387
L 70x70x5	70	5	1823	L 140x140x8	140	8	5875
L 70x70x6	70	6	2171	L 150x150x3	150	3	2406
L 70x70x7	70	7	2514	L 150x150x10	150	10	7830
L 70x70x8	70	8	2850	L 200x200x10	200	10	1053
L 70x70x10	70	10	3510	L 200x200x16	200	16	16700

\* Unless otherwise indicated, profiles are made of EN AW-6060T6 alloy

\* All dimensions are expressed in mm

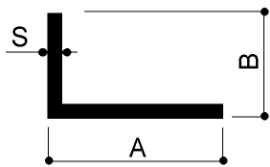

For more dimensions of aluminum L-profiles  
visit the site:

[www.angolari-alluminio.it](http://www.angolari-alluminio.it)

## L-SHAPED PROFILES

PROFILI A ELLE	A	B	S	GR/MT	PROFILI A ELLE	A	B	S	GR/MT
L 8x5x2	8	5	2	110	L 21x9x1	21	9	1	78
L 10x5x1,2	10	5	1,2	45	L 21x11x1	21	11	1	83
L 10x5x1,5	10	5	1,5	55	L 21x12x1,5	21	12	1,5	127
L 10x5x2	10	5	2	70	L 21x13,5x1	21	13,5	1	90
L 12x3x1,2	12	3	1,2	45	L 21x16x1	21	16	1	97
L 12x5x2	12	5	2	91	L 21x17x2	21	17	2	195
L 12x6x1	12	6	1	46	L 22x12x2	22	12	2	173
L 13x9x2	13	9	2	108	L 22x18x2	22	18	2	216
L 14x10x1,5	14	10	1,5	92	L 22x20x1	22	20	1	111
L 14x10x2	14	10	2	119	L 22,2x7x1,2	22,2	7	1,2	92
L 14,3x4,77x1,57	14,3	4,77	1,57	74	L 23x20x2	23	20	2	221
L 15x8x1,5	15	8	1,5	87	L 23,5x16,5x1,5	23,5	16,5	1,5	157
L 15x8x2	15	8	2	113	L 23,6x9x2	23,6	9	2	167
L 15x10x1	15	10	1	65	L 24x5x1	24	5	1	76
L 15x10x1,5	15	10	1,5	95	L 24x5x2	24	5	2	146
L 15x10x2	15	10	2	124	L 24x7x3	24	7	3	227
L 15x12x2	15	12	2	135	L 24x14x1,2	24	14	1,2	119
L 15x13x1,5	15	13	1,5	108	L 24x19x4	24	19	4	422
L 16x8x2	16	8	2	120	L 24x22x2	24	22	2	227
L 16x15x2,5	16	15	2,5	192	L 24,5x16,5x2	24,5	16,5	2	211
L 16,5x15x1,5	16,5	15	1,5	122	L 25x7x1	25	7	1	83
L 17x10x1,5	17	10	1,5	106	L 25x7x2	25	7	2	162
L 17x10x3	17	10	3	193	L 25x8x1,5	25	8	1,5	128
L 17x12x2	17	12	2	146	L 25x9x2	25	9	2	173
L 17,2x7,2x1,2	17,2	7,2	1,2	76	L 25x9,75x3	25	9,75	3	257
L 18x5x2	18	5	2	113	L 25x10x1	25	10	1	92
L 18,5x12x2	18,5	12	2	154	L 25x10x1,5	25	10	1,5	136
L 19x11x2	19	11	2	151	L 25x10x2	25	10	2	178
L 19,6x8,6x1,6	19,6	8,6	1,6	116	L 25x10x2,5	25	10	2,5	219
L 20x3,5x2	20	3,5	2	116	L 25x10x3	25	10	3	259
L 20x7x2	20	7	2	135	L 25x12x2	25	12	2	189
L 20x10x1	20	10	1	79	L 25x12x4	25	12	4	356
L 20x10x1,7	20	10	1,7	143	L 25x14x4	25	14	4	378
L 20x10x1,5	20	10	1,5	115	L 25x15x1	25	15	1	105
L 20x10x2	20	10	2	151	L 25x15x1,5	25	15	1,5	156
L 20x10x3	20	10	3	219	L 25x15x2	25	15	2	205
L 20x12x2	20	12	2	162	L 25x15x2,5	25	15	2,5	253
L 20x14,3x1,3	20	14,3	1,3	116	L 25x15x3	25	15	3	300
L 20x15x1,5	20	15	1,5	135	L 25x17x2	25	17	2	216
L 20x15x2	20	15	2	178	L 25x20x1	25	20	1	119
L 20x15x2,5	20	15	2,5	202	L 25x20x1,5	25	20	1,5	176
L 20x15x3	20	15	3	259	L 25x20x2	25	20	2	232
L 20x18x2	20	18	2	194	L 25x20x2,5	25	20	2,5	286
L 20x18,7x4	20	18,7	4	374	L 25x20x3	25	20	3	340
L 20x25x1,5	20	25	1,5	176	L 25x20x4	25	20	4	443

\* Unless otherwise indicated, profiles are made of EN AW-6060T6 alloy

\* All dimensions are expressed in mm

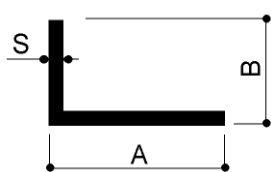

For more dimensions of aluminum L-profiles visit the site:

[www.angolari-alluminio.it](http://www.angolari-alluminio.it)

## L-SHAPED PROFILES

PROFILI A ELLE	A	B	S	GR/MT	PROFILI A ELLE	A	B	S	GR/MT
L 25x20x6	25	20	6	631	L 30x25x1	30	25	1	146
L 25x21,5x5	25	21,5	5	560	L 30x25x1,5	30	25	1,5	217
L 28x12x2	28	12	2	205	L 30x25x2	30	25	2	286
L 28x14,8x1,8	28	14,8	1,8	199	L 30x25x3	30	25	3	421
L 28x17,8x1,2	28	17,8	1,2	145	L 30x27,5x2	30	27,5	2	299
L 28,8x20x1,3	28,8	20	1,3	165	L 32x21x2	32	21	2	275
L 29x20x4	29	20	4	486	L 32x25x4	32	25	4	572
L 30x5x1,2	30	5	1,2	110	L 32,5x17x2	32,5	17	2	257
L 30x10x1,5	30	10	1,5	156	L 33x25x3	33	25	3	445
L 30x10x2	30	10	2	205	L 34x16,5x2	34	16,5	2	262
L 30x10x2,5	30	10	2,5	254	L 34,2x6,5x1,2	34,2	6,5	1,2	126
L 30x10x3	30	10	3	300	L 35x10x1,5	35	10	1,5	176
L 30x11x1,2	30	11	1,2	129	L 35x10x2	35	10	2	232
L 30x11x3,5	30	11	3,5	354	L 35x10x3	35	10	3	351
L 30x12x3	30	12	3	316	L 35x15x1,5	35	15	1,5	197
L 30x13x2	30	13	2	~230	L 35x15x2	35	15	2	259
L 30x15x1	30	15	1	120	L 35x15x3	35	15	3	380
L 30x15x1,5	30	15	1,5	176	L 35x15x4	35	15	4	497
L 30x15x1,8	30	15	1,8	209	L 35x17x3	35	17	2	397
L 30x15x2	30	15	2	232	L 35x20x1,5	35	20	1,5	217
L 30x15x2,3	30	15	2,3	265	L 35x20x1,8	35	20	1,8	258
L 30x15x2,5	30	15	2,5	287	L 35x20x2	35	20	2	286
L 30x15x2,7	30	15	2,7	309	L 35x20x2,7	35	20	2,7	390
L 30x15x3	30	15	3	340	L 35x20x3	35	20	3	421
L 30x15x4	30	15	4	443	L 35x20x4	35	20	4	551
L 30x15x5	30	15	5	540	L 35x25x2	35	25	2	315
L 30x17x1,3	30	17	1,3	165	L 35x25x2,7	35	25	2,7	413
L 30x17x2	30	17	2	243	L 35x25x3	35	25	3	461
L 30x17,5x2	30	17,5	2	247	L 35x25x4	35	25	4	603
L 30x18x1,5	30	18	1,5	188	L 35x30x3	35	30	3	502
L 30x18x2	30	18	2	248	L 35x30x6	35	30	6	956
L 30x20x1	30	20	1	132	L 35x32x2	35	32	2	351
L 30x20x1,20	30	20	1,2	159	L 35x32x4	35	32	4	680
L 30x20x1,25	30	20	1,25	164	L 36x20x2	36	20	4	292
L 30x20x1,4	30	20	1,4	180	L 40x7x1,2	40	7	1,2	142
L 30x20x1,5	30	20	1,5	196	L 40x7x1,5	40	7	1,5	142
L 30x20x2	30	20	2	259	L 40x10x1	40	10	1	132
L 30x20x2,5	30	20	2,5	320	L 40x10x1,5	40	10	1,5	~220
L 30x20x2,7	30	20	2,7	345	L 40x10x2	40	10	2	259
L 30x20x3	30	20	3	380	L 40x10x5	40	10	5	608
L 30x20x4	30	20	4	497	L 40x15x1	40	15	1	146
L 30x20x6	30	20	6	713	L 40x15x1,5	40	15	1,5	217
L 30x21x1	30	21	1	135	L 40x15x2	40	15	2	286
L 30x21x2	30	21	2	265	L 40x15x3	40	15	3	421
L 30x24x4	30	24	4	540	L 40x15x4	40	15	4	551

\* Unless otherwise indicated, profiles are made of EN AW-6060T6 alloy

\* All dimensions are expressed in mm



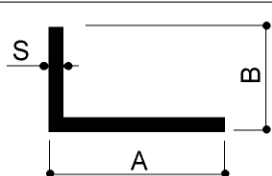

For more dimensions of aluminum L-profiles visit the site:

[www.angolari-alluminio.it](http://www.angolari-alluminio.it)

## L-SHAPED PROFILES

PROFILI A ELLE	A	B	S	GR/MT	PROFILI A ELLE	A	B	S	GR/MT
L 40x17x2	40	17	2	297	L 45x30x5	45	30	5	945
L 40x20x1	40	20	1	161	L 45x40x5	45	40	5	1080
L 40x20x1,25	40	20	1,25	169	L 46x14x2,5	46	14	2,5	388
L 40x20x1,4	40	20	1,4	221	L 50x10x2	50	10	2	313
L 40x20x1,5	40	20	1,5	237	L 50x10x3	50	10	3	462
L 40x20x2	40	20	2	313	L 50x13x2	50	13	2	330
L 40x20x2,5	40	20	2,5	388	L 50x15x1,5	50	15	1,5	257
L 40x20x2,7	40	20	2,7	418	L 50x15x2	50	15	2	340
L 40x20x3	40	20	3	461	L 50x15x2,5	50	15	2,5	421
L 40x20x3,7	40	20	3,7	562	L 50x15x3	50	15	3	502
L 40x20x4	40	20	4	604	L 50x16x3	50	16	3	510
L 40x20x5	40	20	5	742	L 50x17x5	50	17	5	837
L 40x20x6	40	20	6	723	L 50x20x1,2	50	20	1,2	230
L 40x25x2	40	25	2	340	L 50x20x1,25	50	20	1,25	197
L 40x25x2,5	40	25	2,5	421	L 50x20x1,5	50	20	1,5	277
L 40x25x3	40	25	3	502	L 50x20x1,6	50	20	1,6	295
L 40x25x4	40	25	4	688	L 50x20x2	50	20	2	367
L 40x30x1,5	40	30	1,5	277	L 50x20x2,5	50	20	2,5	455
L 40x30x2	40	30	2	367	L 50x20x3	50	20	3	542
L 40x30x2,5	40	30	2,5	455	L 50x20x4	50	20	4	~730
L 40x30x3	40	30	3	542	L 50x20x5	50	20	5	877
L 40x30x3,6	40	30	3,6	646	L 50x20x8	50	20	8	1341
L 40x30x4	40	30	4	712	L 50x25x1,35	50	25	1,35	270
L 40x30x5	40	30	5	877	L 50x25x1,4	50	25	1,4	258
L 40x30x12	40	30	12	1879	L 50x25x1,5	50	25	1,5	306
L 40x35x2	40	35	2	394	L 50x25x2	50	25	2	394
L 41,3x20x1,3	41,3	20	1,3	194	L 50x25x2,5	50	25	2,5	489
L 41,5x15x4	41,5	15	4	560	L 50x25x3	50	25	3	583
L 41,5x19x2	41,5	19	2	313	L 50x25x4	50	25	4	766
L 41,5x25x4	41,5	25	4	675	L 50x25x5	50	25	5	945
L 42x30x4	42	30	4	734	L 50x25x6	50	25	6	1130
L 43x20x3	43	20	3	486	L 50x28x10	50	28	10	1836
L 43x30x2	43	30	2	383	L 50x29x2	50	29	2	416
L 45x15x1,5	45	15	1,5	236	L 50x30x1,5	50	30	1,5	318
L 45x15x2	45	15	2	313	L 50x30x2	50	30	2	421
L 45x20x2	45	20	2	340	L 50x30x3	50	30	3	623
L 45x20x3	45	20	3	503	L 50x30x4	50	30	4	821
L 45x25x1,5	45	25	1,5	543	L 50x30x5	50	30	5	1013
L 45x25x2	45	25	2	367	L 50x30x10	50	30	10	1890
L 45x25x2,5	45	25	2,5	455	L 50x33x5	50	33	5	1053
L 45x25x3	45	25	3	543	L 50x35x3	50	35	3	664
L 45x25x4	45	25	4	713	L 50x35x4	50	35	4	875
L 45x30x1,5	45	30	1,5	298	L 50x40x1,9	50	40	1,9	~480
L 45x30x3	45	30	3	583	L 50x40x2	50	40	2	475
L 45x30x4x	45	30	4	770	L 50x40x3	50	40	3	704

\* Unless otherwise indicated, profiles are made of EN AW-6060T6 alloy

\* All dimensions are expressed in mm

Via Newton, n.12  
20016 Pero (Milano - Italy)  
Tel. +39 02 3535955 r.a. Fax. +39 02 3539929  
E-Mail: info@omar-alluminio.it

Cataloghi Online: [www.omar-alluminio.it](http://www.omar-alluminio.it)  
[www.omat-alluminio.com](http://www.omat-alluminio.com)

CUSTOM ALUMINUM PROFILES / STANDARD / SPECIAL / AND FOR:  
ELECTRONICS / LED / PHOTOVOLTAIC / ROBOTIC AUTOMATION / PNEUMATICS / AUTOMOTIVE



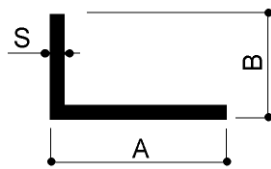

For more dimensions of aluminum L-profiles  
visit the site:

[www.angolari-alluminio.it](http://www.angolari-alluminio.it)

## L-SHAPED PROFILES

PROFILI A ELLE	A	B	S	GR/MT	PROFILI A ELLE	A	B	S	GR/MT
L 50x40x4	50	40	4	929	L 60x40x1,7	60	40	1,7	451
L 50x40x5	50	40	5	1148	L 60x40x1,8	60	40	1,8	477
L 50x42x2	50	42	2	486	L 60x40x2	60	40	2	529
L 51x41x2	51	41	2	486	L 60x40x2,7	60	40	2,7	710
L 52x13x2	52	13	2	341	L 60x40x3	60	40	3	785
L 52x20x2	52	20	2	378	L 60x40x4	60	40	4	1036
L 52x40x2	52	40	2	486	L 60x40x5	60	40	5	1282
L 54x30x4	54	30	4	864	L 60x40x6	60	40	6	1522
L 55x20x2	55	20	2	394	L 60x40x7	60	40	7	1758
L 55x25x5	55	25	5	1013	L 60x40x8	60	40	8	1520
L 55x30x2,5	55	30	2,5	571	L 60x43x3	60	43	3	797
L 55x40x1,8	55	40	1,8	452	L 60x45x6	60	45	6	1604
L 55x45x6	55	45	6	506	L 60x45x10	60	45	10	2565
L 56x15x1,5	56	15	1,5	281	L 60x50x1,5	60	50	1,5	441
L 56,5x41,5x1,5	56,5	41,5	1,5	390	L 60x50x3	60	50	3	869
L 57x19x2	57	19	2	397	L 60x50x5	60	50	5	1417
L 58x35x4	58	35	4	961	L 60x50x8	60	50	8	2203
L 59x30x4	59	30	4	915	L 60x55x3	60	55	3	908
L 60x10x2	60	10	2	367	L 65x50x5	65	50	5	1485
L 60x12x2	60	12	2	550	L 65x50x6	65	50	6	1766
L 60x12x3	60	12	3	559	L 66x55x8	66	55	8	2450
L 60x15x1,2	60	15	1,2	245	L 66x55x10	66	55	10	3008
L 60x15x1,5	60	15	1,5	298	L 62x20x1,5	62	20	1,5	326
L 60x15x2	60	15	2	394	L 62,5x17x2	62,5	17	2	419
L 60x20x1,5	60	20	1,5	318	L 64x58x10	64	58	10	3024
L 60x20x2	60	20	2	421	L 64,7x12x2	64,7	12	2	401
L 60x20x2,5	60	20	2,5	557	L 65x15x2	65	15	2	421
L 60x20x3	60	20	3	624	L 65x20x1,5	65	20	1,5	338
L 60x20x5	60	20	5	1012	L 65x20x2	65	20	2	448
L 60x23x2	60	23	2	437	L 65x40x5	65	40	5	1350
L 60x24,5x2	60	24,5	2	446	L 65x45x10	65	45	10	2700
L 60x25x2	60	25	2	448	L 65x53x8	65	53	8	2376
L 60x25x2,5	60	25	2,5	567	L 67,5x20x2	67,5	20	2	461
L 60x25x3	60	25	3	664	L 69x30x4	69	30	4	1023
L 60x25x5	60	25	5	1080	L 69,5x30x2	69,5	30	2	527
L 60x30x1,3	60	30	1,3	311	L 70x15x2	70	15	2	448
L 60x30x1,5	60	30	1,5	360	L 70x20x1,5	70	20	1,5	358
L 60x30x2	60	30	2	474	L 70x20x2	70	20	2	475
L 60x30x3	60	30	3	704	L 70x20x3	70	20	3	705
L 60x30x4	60	30	4	928	L 70x22x4	70	22	4	950
L 60x30x5	60	30	5	1148	L 70x25x1,5	70	25	1,5	378
L 60x30x8	60	30	8	1771	L 70x25x2	70	25	2	503
L 60x40x1,3	60	40	1,3	348	L 70x25x2,5	70	25	2,5	750
L 60x40x1,5	60	40	1,5	400	L 70x25x6	70	25	6	1442
L 60x40x1,6	60	40	1,6	425	L 70x30x2	70	30	2	527

\* Unless otherwise indicated, profiles are made of EN AW-6060T6 alloy

\* All dimensions are expressed in mm

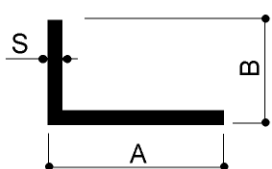

For more dimensions of aluminum L-profiles  
visit the site:

[www.angolari-alluminio.it](http://www.angolari-alluminio.it)

## L-SHAPED PROFILES

PROFILI A ELLE	A	B	S	GR/MT	PROFILI A ELLE	A	B	S	GR/MT
L 70x30x3	70	30	3	786	L 80x40x6	80	40	6	1846
L 70x30x5	70	30	5	1282	L 80x40x8	80	40	8	2419
L 70x40x2	70	40	2	583	L 80x45x4	80	45	4	1307
L 70x40x3	70	40	3	855	L 80x50x2	80	50	2	692
L 70x40x4	70	40	4	1145	L 80x50x3	80	50	3	1033
L 70x40x5	70	40	5	1417	L 80x50x4	80	50	4	1361
L 70x45x8	70	45	8	2311	L 80x50x5	80	50	5	1687
L 70x50x2	70	50	2	640	L 80x50x6	80	50	6	2020
L 70x50x3	70	50	3	948	L 80x50x8	80	50	8	2635
L 70x50x4	70	50	4	1253	L 80x50x10	80	50	10	3240
L 70x50x5	70	50	5	1552	L 80x55x6	80	55	6	2100
L 70x50x6	70	50	6	1847	L 80x60x1,8	80	60	1,8	672
L 70x50x8	70	50	8	2419	L 80x60x3	80	60	3	1110
L 70x50x20	70	50	20	5400	L 80x60x5	80	60	5	1823
L 70x60x12	70	60	12	3823	L 80x60x4	80	60	4	1468
L 74x20x2	74	20	2	497	L 80x60x6	80	60	6	2171
L 75x20x3	75	20	3	745	L 80x60x9	80	60	9	1113
L 75x40x7	75	40	7	2143	L 80x60x10	80	60	10	3510
L 75x45x1,6	75	45	1,6	511	L 80x70x15	80	70	15	5467
L 75x50x5	75	50	5	1620	L 82x27x4	82	27	4	1133
L 75x50x6	75	50	6	1928	L 82x28,5x5	82	28,5	5	~1220
L 75x50x7	75	50	7	2231	L 85x20x2	85	20	2	556
L 75x50x8	75	50	8	2526	L 85x30x3	85	30	3	907
L 75x65x6	75	65	9	2171	L 85x57x10	85	57	10	3564
L 77x10x2	77	10	2	459	L 90x10x1,5	90	10	1,5	403
L 79x30x4	79	30	4	1131	L 90x15x2	90	15	2	556
L 80x8x2	80	8	2	529	L 90x20x3	90	20	3	866
L 80x10x2	80	10	2	475	L 90x23x1,5	90	23	1,5	451
L 80x12,5x3	80	12,5	3	724	L 90x25x3	90	25	3	907
L 80x15x1,5	80	15	1,5	379	L 90x30x3	90	30	3	947
L 80x15x2	80	15	2	502	L 90x40x2	90	40	2	692
L 80x20x2	80	20	2	530	L 90x40x4	90	40	4	1361
L 80x25x2	80	25	2	556	L 90x50x2	90	50	2	748
L 80x25x2,5	80	25	2,5	692	L 90x50x2,5	90	50	2,5	928
L 80x25x3	80	25	3	862	L 90x50x3	90	50	3	1110
L 80x30x2	80	30	2	586	L 90x60x3	90	60	3	1191
L 80x30x3	80	30	3	866	L 90x60x4	90	60	4	1577
L 80x30x3,5	80	30	3,5	1006	L 90x70x2,5	90	70	2,5	1063
L 80x30x4	80	30	4	1144	L 90x80x13	90	80	13	5533
L 80x30x5	80	30	5	1417	L 92x52,1x3	92	52,1	3	1166
L 80x35x6	80	35	6	1847	L 93x10x3	93	10	3	~810
L 80x40x2	80	40	2	637	L 95x30x2,5	95	30	2,5	826
L 80x40x3	80	40	3	947	L 95x50x2	95	50	2	773
L 80x40x4	80	40	4	1252	L 95x55x5	95	55	5	1958
L 80x40x5	80	40	5	1553	L 100x10x1,5	100	10	1,5	445

\* Unless otherwise indicated, profiles are made of EN AW-6060T6 alloy

\* All dimensions are expressed in mm

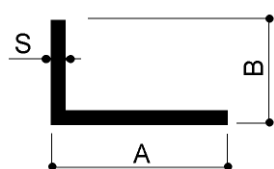

For more dimensions of aluminum L-profiles  
visit the site:

[www.angolari-alluminio.it](http://www.angolari-alluminio.it)

## L-SHAPED PROFILES

PROFILI A ELLE	A	B	S	GR/MT	PROFILI A ELLE	A	B	S	GR/MT
L 100x10x2	100	10	2	583	L 105,50x35,80x8,5	105,5	35,8	8,5	2860
L 100x12x3	100	12	3	884	L 110x15x1,5	110	15	1,5	500
L 100x15x1,5	100	15	1,5	460	L 110x30x2	110	30	2	745
L 100x20x1,5	100	20	1,5	480	L 110x30x3	110	30	3	1109
L 100x20x1,7	100	20	1,7	543	L 110x60x8	110	60	8	3499
L 100x20x2	100	20	2	637	L 115x40x10	115	40	10	3915
L 100x20x2,2	100	20	2,2	700	L 115x65x5	115	65	5	2363
L 100x20x4	100	20	4	1253	L 115x65x6	115	65	6	2819
L 100x23x5	100	23	5	1593	L 115x65x8	115	65	8	3715
L 100x30x2	100	30	2	691	L 115x80x10	115	80	10	4995
L 100x30x3	100	30	3	1029	L 118x19x2	118	19	2	~740
L 100x40x2	100	40	2	745	L 120x20x2	120	20	2	745
L 100x40x2,5	100	40	2,5	928	L 120x30x2	120	30	2	799
L 100x40x3	100	40	3	1110	L 120x30x2,5	120	30	2,5	995
L 100x40x3,5	100	40	3,5	129	L 120x40x2	120	40	2	852
L 100x40x4	100	40	4	1469	L 120x40x3	120	40	3	1272
L 100x40x6	100	40	6	2170	L 120x40x4	120	40	4	1684
L 100x50x2	100	50	2	799	L 120x40x6	120	40	6	2495
L 100x50x3	100	50	3	1190	L 120x44x6	120	44	6	2560
L 100x50x4	100	50	4	1600	L 120x50x2	120	50	2	907
L 100x50x5	100	50	5	1957	L 120x50x3	120	50	3	1353
L 100x50x6	100	50	6	2333	L 120x50x5	120	50	5	2227
L 100x50x7	100	50	7	2703	L 120x55x10	120	55	10	4455
L 100x50x8	100	50	8	3067	L 120x60x3	120	60	3	1434
L 100x50x10	100	50	10	3780	L 120x60x4	120	60	4	1901
L 100x50x12	100	50	12	4471	L 120x60x6	120	60	6	2819
L 100x56x5	100	56	5	~2240	L 120x60x8	120	60	8	3715
L 100x60x3	100	60	3	1272	L 120x65x6/10	120	65	6 10	3357
L 100x60x6	100	60	6	2495	L 120x80x3	120	80	3	1596
L 100x60x7	100	60	7	2892	L 120x80x6	120	80	6	3143
L 100x60x8	100	60	8	~3000	L 120x80x8	120	80	8	4147
L 100x64x8	100	64	8	3370	L 120x80x10	120	80	10	513
L 100x65x6	100	65	6	2576	L 120x90x10	120	90	10	5400
L 100x65x8	100	65	8	3391	L 120x100x4	120	100	4	2333
L 100x65x9	100	65	9	3791	L 120x100x10	120	100	10	5670
L 100x65x11	100	65	11	4573	L 125x25x2	125	25	2	799
L 100x70x1,7	100	70	1,7	780	L 125x80x8	125	80	8	4255
L 100x70x2	100	70	2	907	L 130x30x2,5	130	30	2,5	~1050
L 100x70x8	100	70	8	3536	L 130x30x3	130	30	3	1272
L 100x75x8	100	75	8	3606	L 130x50x5	130	50	5	2362
L 100x80x6	100	80	6	2819	L 130x60x2,5	130	60	2,5	1266
L 100x80x10	100	80	10	4587	L 130x60x10	130	60	10	4860
L 100x80x15	100	80	15	6683	L 130x65x8	130	65	8	4039
L 103x49x6,5x9	103	49	6,5/9	~3900	L 130x65x10	130	65	10	4995
L 105x40x2	105	40	2	772	L 130x75x9	130	75	9	4763

\* Unless otherwise indicated, profiles are made of EN AW-6060T6 alloy

\* All dimensions are expressed in mm

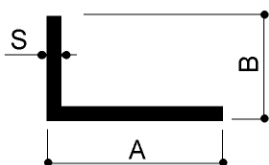

For more dimensions of aluminum L-profiles  
visit the site:

[www.angolari-alluminio.it](http://www.angolari-alluminio.it)

## L-SHAPED PROFILES

PROFILI A ELLE	A	B	S	GR/MT	PROFILI A ELLE	A	B	S	GR/MT
L 130x80x6	130	80	6	3305	L 160x50x4	160	50	4	2014
L 130x80x8	130	80	8	~4500	L 160x60x4	160	60	4	2333
L 130x100x10	130	100	10	5979	L 160x60x6	160	60	6	2635
L 130x100x12	130	100	12	7062	L 160x70x5	160	70	5	3038
L 135x35x2	135	35	2	907	L 160x80x7/5	160	80	7 e 5	3953
L 135x41x6	135	41	6	2754	L 160x80x12	160	80	12	7442
L 135x60x5	135	60	5	2565	L 160x100x15	160	100	15	9922
L 136x100x8	136	100	8	4925	L 160x130x10	160	130	10	7560
L 140x35x5	140	35	5	2295	L 170x40x3	170	40	3	1677
L 140x40x3	140	40	3	1434	L 170x60x6	170	60	6	3628
L 140x40x5	140	40	5	2363	L 180x40x3	180	40	3	1758
L 140x40x6	140	40	6	2819	L 180x40x15	180	40	15	8302
L 140x40x10	140	40	10	4590	L 180x60x15	180	60	15	9113
L 140x50x3	140	50	3	1515	L 180x80x10	180	80	10	6750
L 145x40x3	145	40	3	1475	L 180x150x6	180	150	6	5249
L 150x15x2	150	15	2	892	L 180x160x16	180	160	16	13997
L 150x20x2	150	20	2	907	L 185x115x20	185	115	20	15120
L 150x25x2	150	25	2	960	L 187x30x4	187	30	4	2300
L 150x35x5	150	35	5	2430	L 190x60x8	190	60	8	5230
L 150x50x3	150	50	3	1596	L 190x80x5	190	80	5	3578
L 150x50x4	150	50	4	2117	L 190x120x10	190	120	10	8100
L 150x50x5	150	50	5	2632	L 195x40x3	195	40	3	1880
L 150x50x8	150	50	8	4146	L 200x40x3	200	40	3	1920
L 150x60x4	150	60	4	2225	L 200x40x4	200	40	4	2549
L 150x70x5	150	70	5	2857	L 200x50x3	200	50	3	2001
L 150x75x8	150	75	8	4688	L 200x80x6	200	80	6	4436
L 150x75x9	150	75	9	5249	L 200x100x10	200	100	10	7830
L 150x75x10	150	75	10	5805	L 200x100x15	200	100	15	11543
L 150x80x6	150	80	6	3628	L 200x150x10	200	150	10	9180
L 150x80x8	150	80	8	4795	L 205x70x8	205	70	8	5767
L 150x90x5	150	90	5	3173	L 215x100x8	215	100	8	6631
L 150x100x5	150	100	5	3308	L 220x200x8	220	200	8	8897
L 150x100x10	150	100	10	6480	L 250x80x8	250	80	8	6955
L 150x115x10	150	115	10	6885	L 255x75x10	255	75	10	8640
L 155x40x6	155	40	6	3062	L 260x40x4	260	40	4	3197
L 155x75x10	155	75	10	5940	L 267x70x10	267	70	10	8830
L 155x150x12	155	150	12	9492	L 270x40x8	270	40	8	6523
L 160x40x2	160	40	2	1069	L 280x40x4	280	40	4	3413
L 160x40x3	160	40	3	1596	L 287x98x15	287	98	15	14842
L 160x50x3	160	50	3	1677	L 300x60x6	300	60	6	5730
L 160x50x3,5	160	50	3,5	2014					

DIN43700 electronic enclosures PDF catalog:

[www.contenitori-elettronica.eu](http://www.contenitori-elettronica.eu)

FOLLOWS: CATALOGUE PROFILES 'Z' - 'H' - 'T' - HALF-ROUNDS

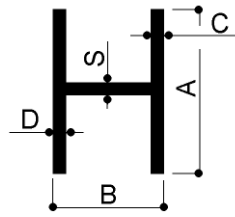

For further dimensions of aluminium H-profiles please visit the website:

[www.profilati-h-alluminio.it](http://www.profilati-h-alluminio.it)

## H-SHAPED PROFILES

PROFILI A "H"	A	B	S	C	D	GR/MT
H 7,8x11,5x1,5	7,8	11,5	1,5			110
H 8x5x1,25	8	5	1,25			60
H 8x20x3x3x3	8	20	3	3	3	243
H 9x8x1,7x1x1	9	8	1,7	1	1	75
H 10x15,7x1,5	10	15,7	1,5			132
H 15x5,5x1,1	15	5,5	1,1			100
H 15x8x1,2x1,5	15	8	1,2	1,5	1,5	100
H 18x10x1,35	18	10	1,35			155
H 18x10x1,5x1,5x1,5	18	10	1,5	1,5	1,5	162
H 18x11x1,5x1,5x3	18	11	1,5	1,5	3	189
H 20x10x1,2	20	10	1,2			154
H 20x12x1,2	20	12	1,2			165
H 20x15,7x1,5	20	15,7	1,5			213
H 20x15,7x2x2x2	20	15,7	2	2	2	213
H 20x30x1,2x1,2x1,2	20	30	1,2	1,2	1,2	251
H 21,5x11x1,5x1,5x1,5	21,5	11	1,5	1,5	1,5	208
H 24x14x2	24	14	2			310
H 25x10x2x2x2	25	10	2	2	2	302
H 25x10x3x2x2	25	10	3	2	2	315
H 25x12,6x8x2,3x2,3	25	12,6	8	2,3	2,3	483
H 27x13x2	27	13	2			375
H 30x60x2,5x2x2	30	60	2,5	2	2	701
H 32x20,8x1,4	32	20,8	1,4			304
H 33,35x18,7x1,35x1,35x1,35	33,35	18,7	1,35	1,35	1,35	301
H 34x17,2x1,5	34	17,2	1,5			335
H 40x15x2	40	15	2			491
H 40x40x2	40	40	2			626
H 40x49,2x2x2x2	40	49,2	2	2	2	572
H 41x70x2	41	70	2			956
H 42x29x2	42	29	2			582
H 42,5x65x2,5x2,5x2,5	42,5	65	2,5	2,5	2,5	979
H 43,4x61,5x1,5	43,4	61,5	1,5			649
H 44x6x2,2	44	6	2,2			~280
H 45,1x43,2x1,1x1,1x1,1	45,1	43,2	1,1	1,1	1,1	390
H 50x25x2	50	25	2			710
H 50x25x3x2x2	50	25	3	2	2	712
H 50x40x3	50	40	3			1000
H 50x80x6x6x3,5	50	80	6	6	3,5	2300
H 52x22x2,5x2,2	52	22	2,5	2,2	2,2	580
H 54,5x37,5x1,5	54,5	37,5	1,5			~390
H 55x37,5x1,5	55	37,5	1,5			~400
H 56x37,5x1,5	56	37,5	1,5			~410
H 80x50x6	80	50	6			2300
H 80x100x4,4x6	80	100	4,4	6		3880
H 80x100x6x8x8	80	100	6			4017

\* Unless otherwise indicated, profiles are made of EN AW-6060T6 alloy

\* All dimensions are expressed in mm

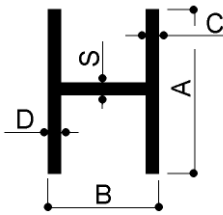

For further dimensions of aluminium H-profiles  
please visit the website:

[www.profilati-h-alluminio.it](http://www.profilati-h-alluminio.it)

## H-SHAPED PROFILES

PROFILI A "H"	A	B	S	C	D	GR/MT
H 80x100x6x8x8	80	100	6	8	8	4817
H 80x350x9x7x5	80	350	9	7	5	8140
H 82x145x3x6	82	145	3	6	6	5260
H 90x80x6	90	80	6			3489
H 99x55x3x2x2	99	55	3	2	2	1482
H 100x70x6	100	70	6			4180
H 100x100x7	100	100	7			5406
H 100x100x10x10x10	100	100	10	10	10	7560
H 100x120x8x6	100	120	8	6		7030
H 100x140x13x9	100	140	13	9		12130
H 101,6x215,9x11,11x7,94	101,6	215,9	11,11	7,94		10830
H 105x56x1,5	105	56	1,5			~1080
H 107x61x5x5x5	107	61	5	5	5	3596
H 120x80x7x9	120	80	7	9		~6000
H 120x200x8x8x6	120	200	8	8	6	8460
H 122x158x5x6	122	158	5	6	6	6690
H 124x306x7x7x6,35	124	306	7	7	6,35	9780
H 140x90x8x10	140	90	8	10	10	7450
H 140x135x5	140	135	5			6197
H 140x135x5x6x6	140	135	5	6	6	6196
H 140x135x5x8x8	140	135	5	8	8	7654
H 160x74x7x10	160	74	7	10		~7000
H 170x116x13x13x18	170	116	13	13	18	16848
H 170x314,7x15x15x10	170	314,7	15	15	10	21850
H 200x132x20x16	200	132	20	16		23500
H 200x136x18x18x20	200	136	18	18	20	25600
H 200x142x23,5x23,5x21,5	200	142	23,5	23,5	21,5	31828
H 200x450x12x12x12	200	450	12	12	12	27180
H 220x170x15x9	220	170	15	9		18620
H 250x220x15x14,5	250	220	15	14,5		26900
H 250x250x13x13x8	250	250	13	13	8	22480
H 314,7x170x10x15	314,7	170	10	15		21460
H 355x310x19x20	355	310	19	20		49700
H 400x308x19x20	400	308	19	20		52160
H 440x307x19x20	440	307	19	20		59200
H 550x200x20x30	550	200	20	30		60700

\* Unless otherwise indicated, profiles are made of EN AW-6060T6 alloy

\* All dimensions are expressed in mm

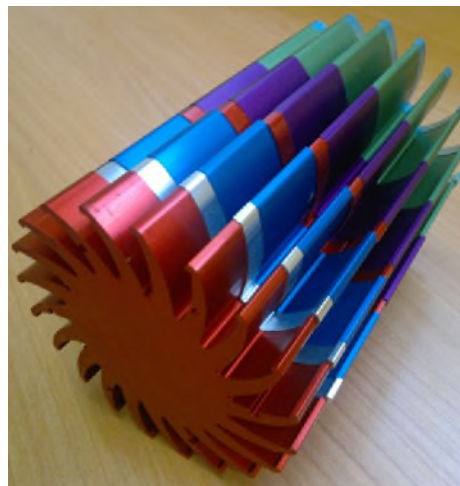

EXAMPLE PHOTO: ANODIZED ALUMINUM PROFILES  
FLOWER HEAT SINKS FOR LED SPOTLIGHTS

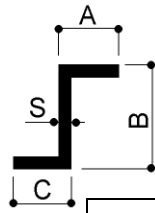

For more dimensions of aluminum Z profiles please visit:

[www.profilati-z-alluminio.it](http://www.profilati-z-alluminio.it)

## PROFILES AND Z

PROFILI A "Z"	A	B	C	S	GR/MT
Z 4x4x16x1	4	4	16	1	59
Z 4x4x22x1	4	4	22	1	76
Z 4x11x7x1	4	11	7	1	54
Z 4,5x4,5x12x1	4,5	4,5	12	1	51
Z 10x10x15x2	10	10	15	2	167
Z 10x10x20x1,5	10	10	20	1,5	150
Z 10x10x20x2	10	10	20	2	194
Z 10x10x25x1,5	10	10	25	1,5	170
Z 10x10x25x2	10	10	25	2	221
Z 10x10x30x1,5	10	10	30	1,5	190
Z 10x10x30x2	10	10	30	2	248
Z 10x90x20x2	10	90	20	2	626
Z 11x11x6x2	11	11	6	2	130
Z 11x11x10x2	11	11	10	2	151
Z 11x16,5x13x2,3	11	16,5	13	2,3	237
Z 12x20x10x3	12	20	10	3	291
Z 12x25x15x2	12	25	15	2	260
Z 12x30x20x1,5	12	30	20	1,5	239
Z 14x14x18x4	14	14	18	4	411
Z 15x15x19x3	15	15	19	3	348
Z 15x15x20x3	15	15	20	3	356
Z 15x15x25x2	15	15	25	2	275
Z 15x15x30x2	15	15	30	2	302
Z 15x15x35x3	15	15	35	3	478
Z 15x20x15x2	15	20	15	2	249
Z 15x25x15x3	15	25	15	3	397
Z 15x33x20x2	15	33	20	2	345
Z 15x45x15x2	15	45	15	2	383
Z 15x50x15x1,5	15	50	15	1,5	313
Z 16x16x15x2	16	16	15	2	232
Z 17x25x17x2	17	25	17	2	297
Z 17x32x17x2	17	32	17	2	335
Z 18x20x21x3	18	20	21	3	430
Z 20x12x10x3	20	12	10	3	291
Z 20x15x20x1,5	20	15	20	1,5	211
Z 20x15x20x3	20	15	20	3	397
Z 20x18x21x3	20	18	21	3	429
Z 20x20x20x2	20	20	20	2	302
Z 20x20x20x3	20	20	20	3	437
Z 20x30x20x3	20	30	20	3	518
Z 25x15x12x2	25	15	12	2	400
Z 25x25x25x2	25	25	25	2	~400
Z 25x25x25x3	25	25	25	3	559
Z 25x29x25x2	25	29	25	2	405
Z 25x40x25x3	25	40	25	3	680

\* Unless otherwise indicated, profiles are made of EN AW-6060T6 alloy

\* All dimensions are expressed in mm



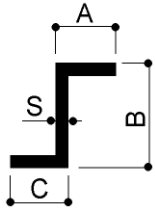

For more dimensions of aluminum Z profiles please visit:

[www.profilati-z-alluminio.it](http://www.profilati-z-alluminio.it)

## PROFILES AND Z

PROFILI A "Z"	A	B	C	S	GR/MT
Z 25x40x50x3	25	40	50	3	883
Z 25x50x25	25	50	25		519
Z 30x30x30x2	30	30	30	2	464
Z 30x30x30x3	30	30	30	3	680
Z 30x40x30x3	30	40	30	3	761
Z 30x50x30x3	30	50	30	3	842
Z 30x86x30x3	30	86	30	3	1135
Z 35x40x35x3	35	40	35	3	842
Z 36x45x36x3	36	45	36	3	899
Z 40x30x40x4	40	30	40	4	1102
Z 40x40x25x3	40	40	25	3	802
Z 40x40x40x3	40	40	40	3	924
Z 40x40x40x4	40	40	40	4	1210
Z 40x60x40x2	40	60	40	2	734
Z 40x65x40x4	40	65	40	4	1480
Z 40x70x40x3	40	70	40	3	1166
Z 40x86x40x3	40	86	40	3	1190
Z 50x50x50x5	50	50	50	5	1890
Z 50x51x50x1,5	50	51	50	1,5	~600
Z 64x15x2	64	15	2		~800

\* Unless otherwise indicated, profiles are made of EN AW-6060T6 alloy

\* All dimensions are expressed in mm



EXAMPLE PHOTO: EXTRUDED ALUMINUM PROFILES CUT TO SIZE AND ANODIZED

Via Newton, n.12

20016 Pero (Milano - Italy)

Tel. +39 02 3535955 r.a. Fax. +39 02 3539929

E-Mail: [info@omar-alluminio.it](mailto:info@omar-alluminio.it)

Cataloghi Online: [www.omar-alluminio.it](http://www.omar-alluminio.it)

[www.omar-alluminio.com](http://www.omar-alluminio.com)

CUSTOM ALUMINUM PROFILES / STANDARD / SPECIAL / AND FOR:

ELECTRONICS / LED / PHOTOVOLTAIC / ROBOTIC AUTOMATION / PNEUMATICS / AUTOMOTIVE

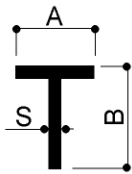

For more dimensions of aluminium T-profiles please visit:

[www.profilati-t-alluminio.it](http://www.profilati-t-alluminio.it)

## T-PROFILES

PROFILI A "T"	A	B	S	GR/MT	PROFILI A "T"	A	B	S	GR/MT
T 6x8x2	6	8	2	65	T 22x15x3	22	15	3	270
T 6x14x2	6	14	2	98	T 22x17,5x2	22	17,5	2	259
T 7x10x1,5	7	10	1,5	63	T 25x10x2	25	10	2	180
T 7,5x7,5x1	7,5	7,5	1	38	T 25x10x4	25	10	4	335
T 8x12x2	8	12	2	97	T 25x14x2	25	14	2	200
T 8x20x2	8	20	2	140	T 25x15x1,5	25	15	1,5	156
T 9x12x2x3	9	12	2 e 3	129	T 25x15x2	25	15	2	205
T 9x32x2	9	32	2	207	T 25x15x3	25	15	3	300
T 10x10x1,5	10	10	1,5	75	T 25x18x3	25	18	3	324
T 10x10x2	10	10	2	97	T 25x20x1,5	25	20	1,5	180
T 10x15x1,5	10	15	1,5	95	T 25x20x2	25	20	2	230
T 10x18x2	10	18	2	140	T 25x21x3,5	25	21	3,5	425
T 10x25x4	10	25	4	335	T 25x23x2	25	23	2	248
T 11,5x11,5x1,5	11,5	11,5	1,5	87	T 25x25x1	25	25	1	132
T 12x12x1,5	12	12	1,5	91	T 25x25x1,3	25	25	1,3	171
T 12x12x2	12	12	2	119	T 25x25x1,5	25	25	1,5	196
T 13x12x2	13	12	2	124	T 25x25x2	25	25	2	259
T 15x10x2	15	10	2	124	T 25x25x3	25	25	3	380
T 15x12x2	15	12	2	135	T 25x25x3,5	25	25	3,5	439
T 15x15x1	15	15	1	78	T 25x25x4	25	25	4	497
T 15x15x1,5	15	15	1,5	115	T 25x35x1,5	25	35	1,5	240
T 15x15x2	15	15	2	151	T 25x50x3	25	50	3	583
T 15x15x3	15	15	3	218	T 27x14x2	27	14	2	210
T 15x40x1,5	15	40	1,5	217	T 27,5x39,4x1,4	27,5	39,4	1,4	~600
T 16x20x1,2	16	20	1,2	113	T 27,5x39,4x1,4x1,7	27,5	39,4	1,4 e 1,7	~700
T 16,5x15x1,5	16,5	15	1,5	122	T 29,5x45x1,7x1,4	29,5	45	1,7 e 1,4	~800
T 17x15x5	17	15	5	365	T 30x10x2	30	10	2	210
T 20x8x2	20	8	2	140	T 30x15x1,3	30	15	1,3	153
T 20x10x1,5	20	10	1,5	115	T 30x15x1,5	30	15	1,5	176
T 20x10x2	20	10	2	150	T 30x15x2	30	15	2	232
T 20x12x2	20	12	2	162	T 30x18x3	30	18	3	365
T 20x13x3	20	13	3	243	T 30x20x1,5	30	20	1,5	196
T 20x15x1,5	20	15	1,5	136	T 30x20x2	30	20	2	259
T 20x15x2	20	15	2	178	T 30x20x3	30	20	3	380
T 20x19,5x1,5	20	19,5	1,5	154	T 30x20x4	30	20	4	497
T 20x20x1	20	20	1	105	T 30x25x2	30	25	2	286
T 20x20x1,5	20	20	1,5	156	T 30x25x3	30	25	3	421
T 20x20x2	20	20	2	205	T 30x26x2	30	26	2	292
T 20x20x3	20	20	3	299	T 30x30x1,5	30	30	1,5	237
T 20x25x1,5	20	25	1,5	176	T 30x30x2	30	30	2	313
T 20x30x2	20	30	2	260	T 30x30x3	30	30	3	461
T 20x35x1,5	20	35	1,5	217	T 30x30x4	30	30	4	605
T 20x35x2,5	20	35	2,5	354	T 30x30x5	30	30	5	743
T 20x40x2	20	40	2	313	T 30x40x3	30	40	3	542
T 20x40x3	20	40	3	462	T 30x43x5	30	43	5	918

\* Unless otherwise indicated, profiles are made of EN AW-6060T6 alloy

\* All dimensions are expressed in mm

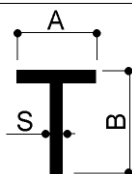

For more dimensions of aluminium T-profiles please visit:

[www.profilati-t-alluminio.it](http://www.profilati-t-alluminio.it)

## T-PROFILES

PROFILI A "T"	A	B	S	GR/MT	PROFILI A "T"	A	B	S	GR/MT
T 30x70x3	30	70	3	786	T 50x35x2	50	35	2	450
T 32x32x3,2	32	32	3,2	~800	T 50x40x4	50	40	4	929
T 35x11x2	35	11	2	241	T 50x40x5	50	40	5	1147
T 35x20x4	35	20	4	550	T 50x50x2	50	50	2	529
T 35x25x2	35	25	2	316	T 50x50x3	50	50	3	786
T 35x35x2	35	35	2	367	T 50x50x3,5	50	50	3,5	913
T 35x35x2,5	35	35	2,5	456	T 50x50x4	50	50	4	1037
T 35x35x3	35	35	3	542	T 50x50x5	50	50	5	1282
T 35x35x5	35	35	5	877	T 50x50x6	50	50	6	~1500
T 35x35x5,5	35	35	5,5	975	T 50x60x2,5	50	60	2,5	727
T 39x25x5	39	25	5	796	T 50x70x3	50	70	3	951
T 40x15x2	40	15	2	286	T 50x80x4	50	80	4	1361
T 40x20x1,5	40	20	1,5	240	T 50x80x5	50	80	5	1685
T 40x20x2	40	20	2	313	T 50x90x2	50	90	2	746
T 40x20x3	40	20	3	462	T 55x40x3	55	40	3	769
T 40x20x4	40	20	4	600	T 60x20x2	60	20	2	421
T 40x20x5	40	20	5	743	T 60x22x3	60	22	3	640
T 40x25x5	40	25	5	810	T 60x30x2	60	30	2	475
T 40x29x4	40	29	4	702	T 60x30x3	60	30	3	705
T 40x30x2	40	30	2	367	T 60x30x4	60	30	4	930
T 40x32x3,2	40	32	3,2	~400	T 60x30x5	60	30	5	1148
T 40x40x2	40	40	2	421	T 60x30x8	60	30	8	1771
T 40x40x3	40	40	3	623	T 60x40x2	60	40	2	529
T 40x40x4	40	40	4	821	T 60x40x2,5	60	40	2,5	658
T 40x40x5	40	40	5	1012	T 60x40x3	60	40	3	785
T 40x50x1,3	40	50	1,3	310	T 60x50x2	60	50	2	580
T 40x50x2	40	50	2	475	T 60x50x2,5	60	50	2,5	727
T 40x50x4	40	50	4	929	T 60x52x2	60	52	2	591
T 40x60x3	40	60	3	786	T 60x54,8x6x5	60	54,8	6 e 5	~800
T 40x60x4	40	60	4	1037	T 60x60x1,8	60	60	1,8	520
T 40x70x4	40	70	4	1145	T 60x60x2	60	60	2	637
T 41,2x17,5x1,2	41,2	17,5	1,2	190	T 60x60x3	60	60	3	945
T 45x45x2	45	45	2	475	T 60x60x4	60	60	4	1252
T 45x45x3	45	45	3	705	T 60x60x5	60	60	5	1553
T 50x17x2	50	17	2	351	T 60x60x6	60	60	6	1847
T 50x20x1,5	50	20	1,5	277	T 60x70x5	60	70	5	1687
T 50x20x2	50	20	2	367	T 60x80x6	60	80	6	2138
T 50x25x2	50	25	2	394	T 60x80x8	60	80	8	2851
T 50x25x4	50	25	4	765	T 60x100x5	60	100	5	2100
T 50x25x5	50	25	5	945	T 60x120x6	60	120	6	2819
T 50x30x2	50	30	2	421	T 60x120x8	60	120	8	3713
T 50x30x3	50	30	3	623	T 60x130x8	60	130	8	4110
T 50x30x4	50	30	4	820	T 65x52,5x2,5	65	52,5	2,5	780
T 50x30x5	50	30	5	1013	T 70x20x3	70	20	3	704
T 50x32x3,2	50	32	3,2	~600	T 70x30x2	70	30	2	529

\* Unless otherwise indicated, profiles are made of EN AW-6060T6 alloy

\* All dimensions are expressed in mm

Via Newton, n.12  
20016 Pero (Milano - Italy)  
Tel. +39 02 3535955 r.a. Fax. +39 02 3539929  
E-Mail: info@omar-alluminio.it

Cataloghi Online: [www.omar-alluminio.it](http://www.omar-alluminio.it)  
[www.omar-alluminio.com](http://www.omar-alluminio.com)

CUSTOM ALUMINIUM PROFILES / STANDARD / SPECIAL / AND FOR:  
ELECTRONICS / LED / PHOTOVOLTAIC / ROBOTIC AUTOMATION / PNEUMATICS / AUTOMOTIVE



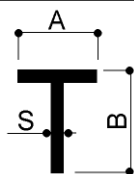

For more dimensions of aluminium T-profiles please visit:

[www.profilati-t-alluminio.it](http://www.profilati-t-alluminio.it)

## T-PROFILES

PROFILI A "T"	A	B	S	GR/MT	PROFILI A "T"	A	B	S	GR/MT
T 70x50x3	70	50	3	948	T 100x45x2	100	45	2	772
T 70x70x3	70	70	3	1109	T 100x50x2	100	50	2	799
T 70x70x5	70	70	5	1823	T 100x50x5	100	50	5	1957
T 75x75x6	75	75	6	2333	T 100x50x8	100	50	8	3110
T 79x51x2	79	51	2	691	T 100x53x3	100	53	3	1215
T 80x20x2	80	20	2	530	T 100x55x1,8	100	55	1,8	744
T 80x25x5	80	25	5	1350	T 100x60x2	100	60	2	853
T 80x40x2	80	40	2	637	T 100x60x2,5	100	60	2,5	1063
T 80x40x4	80	40	4	1253	T 100x60x5	100	60	5	2093
T 80x45x2	80	45	2	664	T 100x60x8	100	60	8	3283
T 80x50x2	80	50	2	691	T 100x80x6	100	80	6	2819
T 80x50x4	80	50	4	1360	T 100x100x3	100	100	3	1596
T 80x50x5	80	50	5	1688	T 100x100x6	100	100	6	3142
T 80x60x4	80	60	4	1469	T 100x100x8	100	100	8	4147
T 80x60x5	80	60	5	1823	T 100x100x10	100	100	10	5130
T 80x60x8	80	60	8	2851	T 105x40x2	105	40	2	772
T 80x70x8	80	70	8	3067	T 110x45x2	110	45	2	826
T 80x74x4	80	74	4	1732	T 115x50x5	115	50	5	~1100
T 80x80x2	80	80	2	1061	T 119x51x2	119	51	2	907
T 80x80x5	80	80	5	2093	T 120x45x2,2	120	45	2,2	970
T 80x80x6	80	80	6	~3000	T 120x50x2	120	50	2	907
T 80x80x7	80	80	7	2892	T 120x50x3	120	50	3	1353
T 80x80x8	80	80	8	3280	T 120x57x6	120	57	6	2770
T 80x100x2	80	100	2	961	T 120x60x2	120	60	2	961
T 80x100x8	80	100	8	3715	T 120x60x3	120	60	3	1434
T 80x109,4x6	80	109,4	6	2960	T 120x80x5	120	80	5	2633
T 80x120x8	80	120	8	4147	T 120x80x8	120	80	8	4147
T 80x120x12x8	80	120	12 e 8	5360	T 120x105x8x5	120	105	8 e 5	~3900
T 80x125x6	80	125	6	3340	T 120x120x8	120	120	8	5053
T 85x40x6	85	40	6	1940	T 140x70x10	140	70	10	5400
T 90x30x2	90	30	2	637	T 140x180x15	140	180	15	1260
T 90x40x4	90	40	4	1253	T 150x118x8	150	118	8	5616
T 90x50x2	90	50	2	746	T 160x50x2	160	50	2	1123
T 90x50x4	90	50	4	1469	T 180x60x5x8	180	60	5 e 8	~5000
T 90x70x4	90	70	4	1700	T 250x200x10x15	250	200	10 e 15	14450
T 90x140x6x10	90	140	6 e 10	4930	T 300x64,5x4x5	300	64,5	4 e 5	4058
T 95x120x10	95	120	10	5535	T 300x160x8x10	300	160	8 e 10	10400
T 100x20x2	100	20	2	637	T 420x200x10x15	420	200	10 e 15	19040

\* Unless otherwise indicated, profiles are made of EN AW-6060T6 alloy

\* All dimensions are expressed in mm

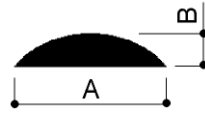

## SEMI ROUND BARS

## SEMI ROUND BARS

BARRE SEMITONDE	A	B	GR/MT	BARRE SEMITONDE	A	B	GR/MT
ST 10x3	10	3	58	ST 25x3,5	25	3,5	175
ST 10x5	10	5	106	ST 25x4	25	4	190
ST 12x3,5	12	3,5	~90	ST 25x5	25	5	230
ST 12x6	12	6	154	ST 25x8	25	8	390
ST 15x3	15	3	83	ST 25x9	25	9	448
ST 15x3,5	15	3,5	100	ST 25x12,5	25	12,5	662
ST 15x4	15	4	130	ST 25,8x10	25,8	10	518
ST 15x5	15	5	115	ST 28x4	28	4	208
ST 16x3	16	3	95	ST 30x3	30	3	170
ST 16x8	16	8	227	ST 30x3,5	30	3,5	205
ST 18x3	18	3	110	ST 30x4	30	4	220
ST 18x3,5	18	3,5	120	ST 30x5	30	5	283
ST 18x4	18	4	140	ST 31x8	31	8	469
ST 18x5	18	5	170	ST 31,8x3,2	31,8	3,2	224
ST 20x3	20	3	115	ST 34,5x12	34,5	12	822
ST 20x3,5	20	3,5	130	ST 40x4	40	4	305
ST 20x4	20	4	155	ST 40x8	40	8	602
ST 20x4,5	20	4,5	168	ST 45x20	45	20	1844
ST 20x5	20	5	189	ST 127x65	127	65	17615
ST 20x6	20	6	231	ST 130x65	130	65	17917
ST 21x10	21	10	439	ST 145x72,5	145	72,5	22510
ST 22x3,5	22	3,5	142	ST 160x80	160	80	25750
ST 22,5x8,5	22,5	8,5	391	ST 180x90	180	90	34830
ST 25x3	25	3	162				

\* Unless otherwise indicated, profiles are made of EN AW-6060T6 alloy

\* All dimensions are expressed in mm

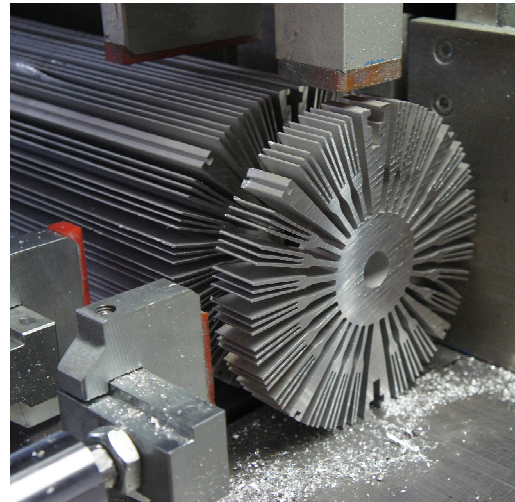

EXAMPLE PHOTO: CUTTING TO SIZE OPERATIONS ARE CARRIED OUT ON ALUMINUM PROFILES

Via Newton, n.12

20016 Pero (Milano - Italy)

Tel. +39 02 3535955 r.a. Fax. +39 02 3539929

E-Mail: info@omar-alluminio.it

Cataloghi Online: [www.omar-alluminio.it](http://www.omar-alluminio.it)

[www.omar-alluminio.com](http://www.omar-alluminio.com)

PROFILATI ALLUMINIO A DISEGNO / STANDARD / SPECIALI / E PER:

ELETTRONICA / LED / FOTOVOLTAICO / AUTOMAZIONE ROBOTICA / PNEUMATICA / AUTOMOTIVE



Via Newton, n.12  
20016 Pero (Milano - Italy)  
Tel. +39 02 3535955 r.a. Fax. +39 02 3539929  
E.Mail: info@omar-alluminio.it

Cataloghi Online: [www.omar-alluminio.it](http://www.omar-alluminio.it)  
[www.omar-alluminio.com](http://www.omar-alluminio.com)

CUSTOM ALUMINIUM PROFILES / STANDARD / SPECIAL / AND FOR:  
ELECTRONICS / LED / PHOTOVOLTAIC / ROBOTIC AUTOMATION / PNEUMATICS / AUTOMOTIVE

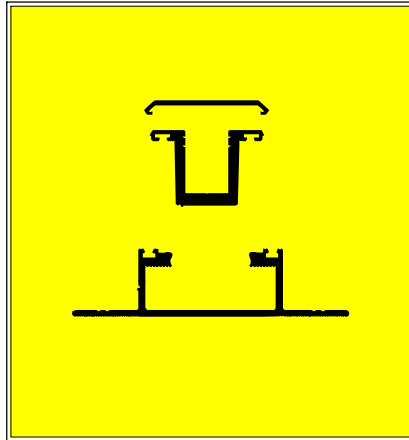

Pdf catalog profiles for photovoltaic / caloric / thermal systems:  
[www.fotovoltaiico.sm](http://www.fotovoltaiico.sm)

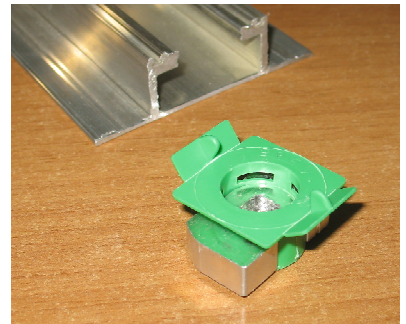
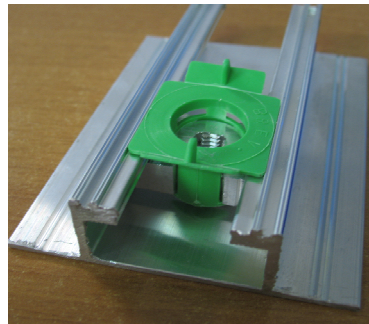

EXAMPLE PHOTO: EXTRUDED ALUMINIUM PROFILES  
FOR PHOTOVOLTAIC / HEAT SYSTEMS





For more sizes of aluminum plates  
visit the site:

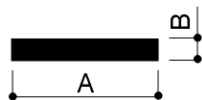

[www.piatti-alluminio.it](http://www.piatti-alluminio.it)

## FLAT BARS

BARRE PIATTE	A	B	GR/MT	BARRE PIATTE	A	B	GR/MT
P 5x2	5	2	27	P 12x8	12	8	259
P 5x3	5	3	41	P 12x10	12	10	324
P 5x4,5	5	4,5	61	P 12,2x4,2	12,2	4,2	138
P 6x2	6	2	32	P 13x3	13	3	106
P 6x3	6	3	49	P 13x6	13	6	211
P 6x4	6	4	65	P 13x7	13	7	245
P 6,5x2,5	6,5	2,5	44	P 13x8	13	8	281
P 6,5x6	6,5	6	104	P 13x9	13	9	316
P 7x4	7	4	76	P 13x10	13,5	10	352
P 7x6	7	6	114	P 13,5x2	13,5	2	73
P 8x2	8	2	43	P 14x3	14	3	113
P 8x2,5	8	2,5	54	P 14x5	14	5	189
P 8x3	8	3	64	P 14x8	14	8	301
P 8x3,5	8	3,5	76	P 14x10	14	10	378
P 8x4	8	4	90	P 14,6x4,8	14,6	4,8	189
P 8x5	8	5	108	P 15x1	15	1	40
P 8x6	8	6	130	P 15x1,5	15	1,5	62
P 8,5x2	8,5	2	46	P 15x2	15	2	81
P 8,5x2,5	8,5	2,5	60	P 15x2,5	15	2,5	102
P 8,5x5	8,5	5	115	P 15x2,7	15	2,7	109
P 8,5x7,6	8,5	7,6	174	P 15x3	15	3	122
P 9x1	9	1	24	P 15x4	15	4	162
P 9x3	9	3	73	P 15x5	15	5	203
P 9,8x2	9,8	2	53	P 15x6	15	6	243
P 10x1,5	10	1,5	61	P 15x7	15	7	280
P 10x2	10	2	54	P 15x8	15	8	324
P 10x2,5	10	2,5	68	P 15x9	15	9	364
P 10x3	10	3	81	P 15x10	15	10	405
P 10x4	10	4	108	P 15x12	15	12	489
P 10x5	10	5	135	P 15,1x3,1	15,1	3,1	126
P 10x6	10	6	162	P 15,1x4,3	15,1	4,3	178
P 10x7	10	7	165	P 15,88x6,35	15,88	6,35	272
P 10x8	10	8	216	P 16x1,5	16	1,5	65
P 11x3	11	3	89	P 16x2	16	2	87
P 11x6	11	6	178	P 16x3	16	3	130
P 11,5x2	11,5	2	63	P 16x4	16	4	173
P 12x1,5	12	1,5	49	P 16x5	16	5	216
P 12x1,6	12	1,6	51	P 16x6	16	6	258
P 12x2	12	2	65	P 16x8	16	8	346
P 12x2,8	12	2,8	91	P 16x10	16	10	432
P 12x3	12	3	97	P 16x12	16	12	518
P 12x3,5	12	3,5	113	P 16x13	16	13	~560
P 12x4	12	4	130	P 16x14	16	14	605
P 12x5	12	5	162	P 16,5x7	16,5	7	312
P 12x6	12	6	194	P 17x4	17	4	184
P 12x7	12	7	230	P 17x6	17	6	275

\* Unless otherwise indicated, profiles are made of EN AW-6060T6 alloy

\* All dimensions are expressed in mm

Via Newton, n.12

20016 Pero (Milano - Italy)

Tel. +39 02 3535955 r.a. Fax. +39 02 3539929

E-Mail: [info@omar-alluminio.it](mailto:info@omar-alluminio.it)

Cataloghi Online: [www.omar-alluminio.it](http://www.omar-alluminio.it)

[www.omar-alluminio.com](http://www.omar-alluminio.com)

CUSTOM ALUMINUM PROFILES / STANDARD / SPECIAL / AND FOR:

ELECTRONICS / LED / PHOTOVOLTAIC / ROBOTIC AUTOMATION / PNEUMATICS / AUTOMOTIVE



For more sizes of aluminum plates  
visit the site:

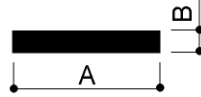

[www.piatti-alluminio.it](http://www.piatti-alluminio.it)

## FLAT BARS

BARRE PIATTE	A	B	GR/MT	BARRE PIATTE	A	B	GR/MT
P 17x8,3	17	8,3	380	P 22,5x20	22,5	20	1260
P 18x1,5	18	1,5	73	P 23x10	23	10	612
P 18x2	18	2	97	P 23,5x5	23,5	5	316
P 18x2,5	18	2,5	122	P 23,5x20	23,5	20	1269
P 18x3	18	3	146	P 24x13	24	13	842
P 18x4	18	4	194	P 24x14	24	14	908
P 18x5	18	5	245	P 24,5x4,5	24,5	4,5	298
P 18x5,5	18	5,5	267	P 24,5x11,7	24,5	11,7	773
P 18x6	18	6	291	P 24,8x9,8	24,8	9,8	656
P 18x8	18	8	445	P 25x1,5	25	1,5	102
P 18x9	18	9	438	P 25x2	25	2	135
P 18x10	18	10	486	P 25x2,5	25	2,5	169
P 18,5x2,28	18,5	2,28	114	P 25x3	25	3	203
P 19x3,5	19	3,5	181	P 25x3,5	25	3,5	236
P 19x5	19	5	257	P 25x4	25	4	270
P 19x6	19	6	308	P 25x5	25	5	338
P 19x11	19	11	564	P 25x6	25	6	405
P 19,8x9,8	19,8	9,8	524	P 25x7	25	7	473
P 20x1	20	1	54	P 25x8	25	8	540
P 20x2	20	2	108	P 25x10	25	10	675
P 20x2,5	20	2,5	135	P 25x12	25	12	810
P 20x3	20	3	162	P 25x15	25	15	1013
P 20x4	20	4	216	P 25x16	25	16	1080
P 20x5	20	5	270	P 25x20	25	20	1350
P 20x6	20	6	324	P 26x6	26	6	421
P 20x7	20	7	380	P 26x16	26	16	1123
P 20x8	20	8	432	P 27x18	27	18	1361
P 20x10	20	10	540	P 27,6x10	27,6	10	745
P 20x12	20	12	648	P 28x3	28	3	227
P 20x13	20	13	702	P 28x4	28	4	300
P 20x13,5	20	13,5	729	P 28x6	28	6	454
P 20x15	20	15	810	P 28x8	28	8	605
P 20x16	20	16	864	P 28x10	28	10	756
P 21x16	21	16	941	P 28x11,5	28	11,5	869
P 22x1,5	22	1,5	89	P 28x13	28	13	983
P 22x2,5	22	2,5	14	P 28x16	28	16	1210
P 22x2	22	2	178	P 28x18	28	18	1411
P 22x3	22	3	178	P 28x25	28	25	1890
P 22x4	22	4	238	P 29x11	29	11	860
P 22x6	22	6	356	P 29,5x4,85	29,5	4,85	386
P 22x8	22	8	475	P 29,7x4	29,7	4	320
P 22x16	22	16	954	P 29,8x11,8	29,8	11,8	949
P 22x18	22,23	18	1069	P 30x1	30	1	80
P 22,23x4,76	22,23	4,76	286	P 30x1,5	30	1,5	122
P 22,5x3	22,5	3	182	P 30x2	30	2	162
P 22,5x10	22,5	10	607	P 30x2,5	30	2,5	203

\* Unless otherwise indicated, profiles are made of EN AW-6060T6 alloy  
\* All dimensions are expressed in mm



For more sizes of aluminum plates  
visit the site:

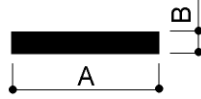

[www.piatti-alluminio.it](http://www.piatti-alluminio.it)

## FLAT BARS

BARRE PIATTE	A	B	GR/MT	BARRE PIATTE	A	B	GR/MT
P 30x3	30	3	243	P 35x25	35	25	2363
P 30x4	30	4	324	P 35x30	35	30	2835
P 30x5	30	5	405	P 36x2	36	2	194
P 30x6	30	6	486	P 36x10	36	10	971
P 30x7	30	7	567	P 36x12	36	12	1166
P 30x8	30	8	648	P 36x32	36	32	3110
P 30x10	30	10	810	P 38x2,8	38	2,8	287
P 30x12	30	12	972	P 38x3	38	3	308
P 30x12,3	30	12,3	996	P 38x8	38	8	821
P 30x13	30	13	1053	P 38x15	38	15	1540
P 30x15	30	15	1215	P 38x25	38	25	2565
P 30x20	30	20	1620	P 38x27	38	27	2770
P 30x22	30	22	1848	P 38x30	38	30	3192
P 30x25	30	25	2025	P 38x32	38	32	3405
P 30,5x28	30,5	28	2391	P 38x35	38	35	3591
P 31x4	31	4	335	P 38,1x25,4	38,1	25,4	2613
P 31x16	31	16	1339	P 39x4	39	4	424
P 31x22	31	22	1910	P 39x10	39	10	1053
P 31x28	31	28	2344	P 40x1,5	40	1,5	162
P 31,96x23	31,96	23	1988	P 40x2	40	2	216
P 32x3	32	3	259	P 40x3	40	3	324
P 32x4,5	32	4,5	389	P 40x4	40	4	432
P 32x10	32	10	864	P 40x5	40	5	540
P 32x15	32	15	1296	P 40x6	40	6	648
P 32x18	32	18	1613	P 40x7	40	7	785
P 32x22	32	22	1901	P 40x8	40	8	864
P 32x31	32	31	2678	P 40x9	40	9	972
P 33x6	33	6	534	P 40x10	40	10	1080
P 33x22	33	22	1960	P 40x11	40	11	1188
P 34x2	34	2	184	P 40x12	40	12	1296
P 34x16	34	16	1523	P 40x15	40	15	1620
P 35x2	35	2	189	P 40x16	40	16	1728
P 35x2,5	35	2,5	236	P 40x18	40	18	1944
P 35x2,7	35	2,7	~250	P 40x20	40	20	2160
P 35x3	35	3	284	P 40x25	40	25	2700
P 35x4	35	4	368	P 40x30	40	30	3240
P 35x5	35	5	473	P 40x31	40	31	3348
P 35x6	35	6	576	P 40x32	40	32	3456
P 35x7	35	7	662	P 40x35	40	35	3780
P 35x8	35	8	756	P 40x45	40	45	4860
P 35x10	35	10	945	P 41x7	41	7	775
P 35x12	35	12	1134	P 42x2	42	2	2270
P 35x13	35	13	1228	P 42x8	42	8	907
P 35x14	35	14	1372	P 42x9	42	9	1020
P 35x15	35	15	1418	P 43,5x8,5	43,5	8,5	987
P 35x20	35	20	1890	P 44x3	44	3	356

\* Unless otherwise indicated, profiles are made of EN AW-6060T6 alloy  
\* All dimensions are expressed in mm

Via Newton, n.12  
20016 Pero (Milano - Italy)  
Tel. +39 02 353955 r.a. Fax. +39 02 3539929  
E-Mail: info@omar-alluminio.it

Cataloghi Online: [www.omar-alluminio.it](http://www.omar-alluminio.it)  
[www.omar-alluminio.com](http://www.omar-alluminio.com)

CUSTOM ALUMINUM PROFILES / STANDARD / SPECIAL / AND FOR:  
ELECTRONICS / LED / PHOTOVOLTAIC / ROBOTIC AUTOMATION / PNEUMATICS / AUTOMOTIVE

For more sizes of aluminum plates  
visit the site:

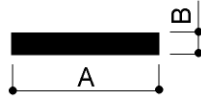

[www.piatti-alluminio.it](http://www.piatti-alluminio.it)

## FLAT BARS

BARRE PIATTE	A	B	GR/MT	BARRE PIATTE	A	B	GR/MT
P 44x25	44	25	297	P 50x44	50	44	5940
P 44,45x25,4	44,45	25,4	3048	P 50x45	50	45	6075
P 45x2	45	2	243	P 50,5x8,5	50,5	8,5	1159
P 45x3	45	3	365	P 50,8x12,7	50,8	12,7	1742
P 45x4	45	4	486	P 50,8x15,88	50,8	15,88	2178
P 45x5	45	5	608	P 52x9	52	9	1263
P 45x6	45	6	729	P 52x34	52	34	4774
P 45x7	45	7	851	P 53x22,5	53	22,5	3220
P 45x8	45	8	972	P 53x30,5	53	30,5	4365
P 45x10	45	10	1215	P 53x15	53	15	2147
P 45x12	45	12	1460	P 53x42	53	42	6010
P 45x15	45	15	1823	P 54x3	54	3	437
P 45x20	45	20	2430	P 54x5	54	5	729
P 45x23	45	23	2795	P 54x10	54	10	1457
P 45x25	45	25	3038	P 54x22	54	22	3208
P 45x30	45	30	3672	P 54,5x18,5	54,5	18,5	2722
P 45x35	45	35	4410	P 55x1	55	1	149
P 45x40	45	40	4860	P 55x2	55	2	297
P 45x42	45	42	5103	P 55x3	55	3	450
P 47x2	47	2	253	P 55x4	55	4	594
P 47x4	47	4	508	P 55x5	55	5	891
P 48x6,7	48	6,7	868	P 55x6	55	6	891
P 48x15	48	15	1945	P 55x8	55	8	1188
P 48x18	48	18	2333	P 55x10	55	10	1485
P 48x24,5	48	24,5	3173	P 55x12	55	12	1780
P 48x35	48	35	4536	P 55x14	55	14	2079
P 50x1,5	50	1,5	203	P 55x15	55	15	2228
P 50x2	50	2	270	P 55x19	55	19	2822
P 50x3	50	3	405	P 55x20	55	20	2970
P 50x4	50	4	540	P 55x25	55	25	3713
P 50x5	50	5	675	P 55x30	55	30	4455
P 50x6	50	6	810	P 55x35	55	35	5200
P 50x7	50	7	945	P 55x40	55	40	5940
P 50x8	50	8	1080	P 55x45	55	45	6675
P 50x9	50	9	1215	P 56x8	56	8	1210
P 50x10	50	10	1350	P 56x16	56	16	2419
P 50x12	50	12	1620	P 58x2	58	2	313
P 50x15	50	15	2025	P 58x6	58	6	940
P 50x16	50	16	2240	P 58x10	58	10	1566
P 50x20	50	20	2700	P 58x32	58	32	5011
P 50x25	50	25	3375	P 60x2	60	2	324
P 50x28	50	28	3780	P 60x3	60	3	486
P 50x30	50	30	4050	P 60x4	60	4	648
P 50x33	50	33	4455	P 60x5	60	5	810
P 50x35	50	35	4725	P 60x6	60	6	972
P 50x40	50	40	5400	P 60x7	60	7	1134

\* Unless otherwise indicated, profiles are made of EN AW-6060T6 alloy

\* All dimensions are expressed in mm

For more sizes of aluminum plates  
visit the site:

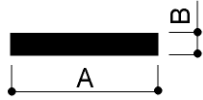

[www.piatti-alluminio.it](http://www.piatti-alluminio.it)

## FLAT BARS

BARRE PIATTE	A	B	GR/MT	BARRE PIATTE	A	B	GR/MT
P 60x8	60	8	1296	P 70x1,5	70	1,5	284
P 60x9	60	9	1458	P 70x2	70	2	378
P 60x10	60	10	1620	P 70x2,1	70	2,1	400
P 60x12	60	12	1944	P 70x2,5	70	2,5	472
P 60x13	60	13	2106	P 70x3	70	3	567
P 60x15	60	15	2430	P 70x4	70	4	756
P 60x20	60	20	3240	P 70x5	70	5	945
P 60x25	60	25	4050	P 70x6	70	6	1134
P 60x27	60	27	4374	P 70x7	70	7	1323
P 60x30	60	30	4860	P 70x8	70	8	1512
P 60x35	60	35	5670	P 70x10	70	10	1890
P 60x40	60	40	6480	P 70x12	70	12	2268
P 60x45	60	45	7290	P 70x15	70	15	2835
P 60x50	60	50	8100	P 70x20	70	20	3780
P 60x55	60	55	8910	P 70x25	70	25	4725
P 63x10	63	10	1701	P 70x30	70	30	5670
P 63x12	63	12	2041	P 70x32	70	32	6045
P 63,5x12,7	63,5	12,7	2177	P 70x35	70	35	6615
P 63,5x15,88	63,5	15,88	2723	P 70x40	70	40	7560
P 63,5x19,05	63,5	19,05	3266	P 70x41	70	41	7749
P 64x4	64	4	691	P 70x45	70	45	8505
P 64x10	64	10	1728	P 70x50	70	50	9450
P 64x15	64	15	2592	P 70x60	70	60	11340
P 64x37	64	37	6394	P 71x29	71	29	5554
P 64,5x5	64,5	5	871	P 75x2	75	2	410
P 65x3	65	3	527	P 75x3	75	3	608
P 65x3,3	65	3,3	579	P 75x4	75	4	810
P 65x4	65	4	702	P 75x5	75	5	1012
P 65x6	65	6	1053	P 75x6	75	6	1215
P 65x8	65	8	1404	P 75x7	75	7	1418
P 65x10	65	10	1755	P 75x8	75	8	1620
P 65x12	65	12	2106	P 75x10	75	10	2025
P 65x17	65	17	2984	P 75x12	75	12	2430
P 65x20	65	20	3515	P 75x15	75	15	3037
P 65x30	65	30	5265	P 75x19	75	19	3848
P 65x35	65	35	6143	P 75x20	75	20	4050
P 65x40	65	40	7020	P 75x25	75	25	5062
P 65x45	65	45	7897	P 75x30	75	30	6075
P 65x50	65	50	8775	P 75x32	75	32	6480
P 65,5x25	65,5	25	4421	P 75x35	75	35	7090
P 66x5	66	5	891	P 75x40	75	40	8100
P 67x12	67	12	2171	P 75x45	75	45	9113
P 68x41	68	41	7528	P 75x50	75	50	10130
P 68x52	68	52	9547	P 75x60	75	60	12150
P 68,15x5	68,15	5	920	P 75x65	75	65	13160
P 69x30	69	30	5589	P 75x70	75	70	14172

\* Unless otherwise indicated, profiles are made of EN AW-6060T6 alloy

\* All dimensions are expressed in mm

Via Newton, n.12

20016 Pero (Milano - Italy)

Tel. +39 02 3535955 r.a. Fax. +39 02 3539929

E-Mail: [info@omar-alluminio.it](mailto:info@omar-alluminio.it)

Cataloghi Online: [www.omar-alluminio.it](http://www.omar-alluminio.it)

[www.omar-alluminio.com](http://www.omar-alluminio.com)

CUSTOM ALUMINUM PROFILES / STANDARD / SPECIAL / AND FOR:

ELECTRONICS / LED / PHOTOVOLTAIC / ROBOTIC AUTOMATION / PNEUMATICS / AUTOMOTIVE

For more sizes of aluminum plates  
visit the site:

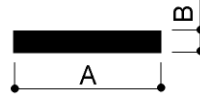

[www.piatti-alluminio.it](http://www.piatti-alluminio.it)

## BARRE PIATTE

BARRE PIATTE	A	B	GR/MT	BARRE PIATTE	A	B	GR/MT
P 75,5x33,5	75,5	33,5	6829	P 85x15	85	15	3443
P 76x4	76	4	820	P 85x16	85	16	3672
P 76x4,4	76	4,4	~850	P 85x20	85	20	4590
P 76x4,6	76	4,6	943	P 85x30	85	30	6884
P 76x19	76	19	3900	P 85x35	85	35	8033
P 76x20	76	20	4104	P 88x5	88	5	1188
P 76x35	76	35	7182	P 88x39	88	39	8791
P 76,2x12,7	76,2	12,7	2613	P 88x52	88	52	12355
P 76,2x15,88	76,2	15,88	3267	P 88,9x12,7	88,9	12,7	3048
P 77x2	77	2	416	P 88,9x19,05	88,9	19,05	4573
P 77x7	77	7	1455	P 88,9x25,4	88,9	25,4	6097
P 79x65	79	65	13865	P 90x2	90	2	486
P 80x1,5	80	1,5	324	P 90x3	90	3	729
P 80x2	80	2	432	P 90x4	90	4	972
P 80x3	80	3	648	P 90x4,5	90	4,5	1093
P 80x4	80	4	864	P 90x5	90	5	1215
P 80x5	80	5	1080	P 90x6	90	6	1458
P 80x6	80	6	1296	P 90x7	90	7	1701
P 80x7	80	7	1568	P 90x8	90	8	1944
P 80x7,5	80	7,5	1620	P 90x10	90	10	2430
P 80x8	80	8	1728	P 90x12	90	12	2916
P 80x10	80	10	2160	P 90x15	90	15	3645
P 80x12	80	12	2592	P 90x17	90	17	4131
P 80x14	80	14	3024	P 90x20	90	20	4860
P 80x15	80	15	3240	P 90x22	90	22	5346
P 80x19	80	19	4104	P 90x25	90	25	6075
P 80x20	80	20	4320	P 90x30	90	30	7290
P 80x25	80	25	5400	P 90x31	90	31	7533
P 80x30	80	30	6480	P 90x35	90	35	8504
P 80x35	80	35	7560	P 90x38,1	90	38,1	9258
P 80x40	80	40	8640	P 90x40	90	40	9720
P 80x42	80	42	9072	P 90x45	90	45	11340
P 80x45	80	45	9720	P 90x50	90	50	12150
P 80x50	80	50	10800	P 90x60	90	60	14580
P 80x55	80	55	11880	P 90x70	90	70	17010
P 80x60	80	60	12960	P 90x80	90	80	19440
P 80x70	80	70	15120	P 91x30,7	91	30,7	7543
P 82x38	82	38	8413	P 92x4	92	4	993
P 83x20	83	20	4482	P 92x5	92	5	1242
P 84x55	84	55	12474	P 92x6	92	6	1049
P 84x62	84	62	14062	P 93x4	93	4	1005
P 85x2	85	2	459	P 95x5	95	5	1282
P 85x3	85	3	689	P 95x6	95	6	1539
P 85x4	85	4	920	P 95x7	95	7	1795
P 85x7	85	7	1606	P 95x12	95	12	3078
P 85x10	85	10	2295	P 95x15	95	15	3847

\* Unless otherwise indicated, profiles are made of EN AW-6060T6 alloy

\* All dimensions are expressed in mm



For more sizes of aluminum plates  
visit the site:

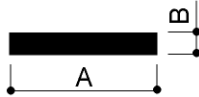

[www.piatti-alluminio.it](http://www.piatti-alluminio.it)

## FLAT BARS

BARRE PIATTE	A	B	GR/MT	BARRE PIATTE	A	B	GR/MT
P 95x25	95	25	6412	P 105x34	105	34	9639
P 95x45	95	45	11543	P 105x35	105	35	9919
P 95x60	95	60	15390	P 105x55	105	55	16286
P 95x65	95	65	17290	P 105x95	105	95	26932
P 95x70	95	70	17955	P 107x6	107	6	1733
P 95x80	95	80	20520	P 109x15	109	15	4414
P 96x6	96	6	1555	P 109x20	109	20	5886
P 97x37	97	37	9690	P 110x2,5	110	2,5	739
P 98x10	98	10	2646	P 110x3	110	3	890
P 98x35	98	35	9252	P 110x5	110	5	1485
P 100x2	100	2	540	P 110x6	110	6	1782
P 100x2,5	100	2,5	674	P 110x8	110	8	2376
P 100x3	100	3	810	P 110x8,5	110	8,5	2525
P 100x3,5	100	3,5	945	P 110x10	110	10	2970
P 100x4	100	4	1080	P 110x12	110	12	3564
P 100x5	100	5	1350	P 110x15	110	15	4455
P 100x6	100	6	1620	P 110x18	110	18	5346
P 100x7	100	7	1890	P 110x20	110	20	5940
P 100x8	100	8	2160	P 110x25	110	25	7424
P 100x9	100	9	2430	P 110x35	110	35	10395
P 100x10	100	10	2700	P 110x50	110	50	14850
P 100x12	100	12	3240	P 110x55	110	55	17061
P 100x12,5	100	12,5	3375	P 110x65	110	65	19303
P 100x15	100	15	4050	P 110x70	110	70	20800
P 100x20	100	20	5400	P 112x4	112	4	1210
P 100x22	100	22	5940	P 112x4,5	112	4,5	1244
P 100x25	100	25	6750	P 114,3x76,2	114,3	76,2	23515
P 100x30	100	30	8100	P 115x4	115	4	1242
P 100x35	100	35	9450	P 115x8	115	8	2484
P 100x40	100	40	10800	P 120x2	120	2	648
P 100x45	100	45	12148	P 120x2,5	120	2,5	810
P 100x50	100	50	13500	P 120x3	120	3	972
P 100x60	100	60	16200	P 120x4	120	4	1296
P 100x70	100	70	18899	P 120x5	120	5	1620
P 100x80	100	80	21599	P 120x6	120	6	1944
P 100,1x3,9	100,1	3,9	1050	P 120x7	120	7	2268
P 101,4x31,75	101,4	31,75	8693	P 120x8	120	8	2592
P 101,6x12,7	101,6	12,7	3484	P 120x10	120	10	3240
P 101,6x15,88	101,6	15,88	4356	P 120x12	120	12	3888
P 101,6x19,05	101,6	19,05	5226	P 120x15	120	15	4860
P 101,6x63,5	101,6	63,5	17418	P 120x20	120	20	6480
P 101,6x76,2	101,6	76,2	20898	P 120x25	120	25	8100
P 103x4	103	4	1112	P 120x30	120	30	9720
P 105x4,8	105	4,8	1365	P 120x35	120	35	11340
P 105x5	105	5	1417	P 120x36	120	36	11664
P 105x6	105	6	1701	P 120x40	120	40	12960

\* Unless otherwise indicated, profiles are made of EN AW-6060T6 alloy

\* All dimensions are expressed in mm

Via Newton, n.12

20016 Pero (Milano - Italy)

Tel. +39 02 3535955 r.a. Fax. +39 02 3539929

E-Mail: [info@omar-alluminio.it](mailto:info@omar-alluminio.it)

Cataloghi Online: [www.omar-alluminio.it](http://www.omar-alluminio.it)

[www.omar-alluminio.com](http://www.omar-alluminio.com)

CUSTOM ALUMINUM PROFILES / STANDARD / SPECIAL / AND FOR:

ELECTRONICS / LED / PHOTOVOLTAIC / ROBOTIC AUTOMATION / PNEUMATICS / AUTOMOTIVE



For more sizes of aluminum plates  
visit the site:

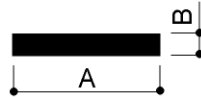

[www.piatti-alluminio.it](http://www.piatti-alluminio.it)

## FLAT BARS

BARRE PIATTE	A	B	GR/MT	BARRE PIATTE	A	B	GR/MT
P 120x45	120	45	14580	P 140x3	140	3	1134
P 120x50	120	50	16200	P 140x5	140	5	1890
P 120x55	120	55	17820	P 140x6	140	6	2268
P 120x60	120	60	19440	P 140x8	140	8	3024
P 120x70	120	70	22679	P 140x10	140	10	3780
P 120x80	120	80	25917	P 140x12	140	12	4536
P 120x100	120	100	32400	P 140x15	140	15	5670
P 121x30	121	30	9801	P 140x20	140	20	7560
P 125x10	125	10	3375	P 140x25	140	25	9447
P 125x12	125	12	4050	P 140x30	140	30	11340
P 125x15	125	15	5081	P 140x40	140	40	15120
P 125x20	125	20	6750	P 140x70	140	70	26460
P 125x30	125	30	10125	P 140,3x40,3	140,3	40,3	15300
P 125x32	125	32	10800	P 140,5x5,5	140,5	5,5	2086
P 125x50	125	50	16875	P 141x21	141	21	7995
P 126,2x12,7	126,2	12,7	4326	P 145x20	145	20	7830
P 127x52	127	52	17900	P 145x35	145	35	13702
P 130x2	130	2	702	P 145x60	145	60	23489
P 130x4	130	4	1404	P 150x3	150	3	1215
P 130x5	130	5	1755	P 150x4	150	4	1620
P 130x5,2	130	5,2	~1800	P 150x5	150	5	2025
P 130x6	130	6	2106	P 150x6	150	6	2430
P 130x7	130	7	2457	P 150x6,5	150	6,5	2633
P 130x8	130	8	2808	P 150x7	150	7	2835
P 130x10	130	10	3510	P 150x8	150	8	3240
P 130x12	130	12	4212	P 150x10	150	10	4050
P 130x15	130	15	5265	P 150x12	150	12	4860
P 130x20	130	20	7018	P 150x15	150	15	6075
P 130x25	130	25	8775	P 150x18	150	18	7290
P 130x25,2	130	25,2	8845	P 150x20	150	20	8100
P 130x29	130	29	10179	P 150x25	150	25	10125
P 130x30	130	30	10530	P 150x30	150	30	12150
P 130x35	130	35	12285	P 150x35	150	35	14175
P 130x40	130	40	14039	P 150x40	150	40	16200
P 130x45	130	45	15800	P 150x45	150	45	18230
P 130x50	130	50	17550	P 150x50	150	50	20250
P 130x60	130	60	21060	P 150x60	150	60	24300
P 130x70	130	70	24570	P 150x70	150	70	28350
P 130x80	130	80	28080	P 150x75	150	75	30375
P 130,4x50,4	130,4	50,4	17741	P 150x80	150	80	32400
P 131x30	131	30	10611	P 150x100	150	100	40500
P 133x6	133	6	2155	P 152,4x50,8	152,4	50,8	20902
P 134x4	134	4	1447	P 153x128	153	128	55226
P 135x3	135	3	1100	P 155x4	155	4	1673
P 135x67	135	67	24450	P 155x20	155	20	8370
P 136x4	136	4	1469	P 155x30	155	30	12554

\* Unless otherwise indicated, profiles are made of EN AW-6060T6 alloy

\* All dimensions are expressed in mm



For more sizes of aluminum plates  
visit the site:

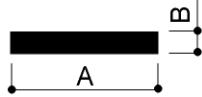

[www.piatti-alluminio.it](http://www.piatti-alluminio.it)

## FLAT BARS

BARRE PIATTE	A	B	GR/MT	BARRE PIATTE	A	B	GR/MT
P 155,5x10	155,5	10	4199	P 180x25	180	25	12150
P 160x2	160	2	806	P 180x30	180	30	14580
P 160x3	160	3	1296	P 180x35	180	35	17010
P 160x5	160	5	2160	P 180x40	180	40	19440
P 160x6	160	6	2592	P 180x45	180	45	21870
P 160x8	160	8	3456	P 180x50	180	50	24300
P 160x10	160	10	4320	P 180x60	180	60	29160
P 160x12	160	12	5184	P 180x70	180	70	34020
P 160x15	160	15	6480	P 180x80	180	80	38880
P 160x20	160	20	8640	P 180x100	180	100	48600
P 160x25	160	25	10800	P 183x7	183	7	3459
P 160x30	160	30	12960	P 190x8	190	8	4104
P 160x40	160	40	17280	P 190x15	190	15	7695
P 160x50	160	50	21599	P 200x3	200	3	1620
P 160x60	160	60	25920	P 200x4	200	4	2160
P 160x65	160	65	29120	P 200x5	200	5	2700
P 160x85	160	85	38080	P 200x6	200	6	3240
P 160x90	160	90	38880	P 200x8	200	8	4320
P 160x120	160	120	53760	P 200x10	200	10	5400
P 161x31	161	31	13476	P 200x12	200	12	6480
P 162x32	162	32	14000	P 200x15	200	15	8100
P 165x8	165	8	3564	P 200x20	200	20	10800
P 165x10	165	10	4450	P 200x22	200	22	11880
P 165x125	165	125	58000	P 200x25	200	25	13500
P 168x13,5	168	13,5	6124	P 200x30	200	30	16200
P 170x2,5	170	2,5	~1300	P 200x35	200	35	18900
P 170x4	170	4	1836	P 200x40	200	40	21600
P 170x14	170	14	6426	P 200x45	200	45	24300
P 170x15	170	15	6885	P 200x50	200	50	27000
P 170x18	170	18	8135	P 200x60	200	60	32397
P 170x25	170	25	11475	P 200x70	200	70	37800
P 170x30	170	30	13770	P 200x80	200	80	43200
P 170x60	170	60	27540	P 200x100	200	100	54000
P 174x12	174	12	5638	P 203x105	203	105	~57500
P 174x37	174	37	17381	P 206x4	206	4	2225
P 175x8	175	8	3780	P 210x19,5	210	19,5	11056
P 175x10	175	10	4724	P 210x30	210	30	17010
P 175x15	175	15	7086	P 215x7	215	7	4064
P 177x3	177	3	1434	P 216x19	216	19	11081
P 180x4	180	4	1944	P 220x5	220	5	2970
P 180x5	180	5	2430	P 220x6	220	6	3564
P 180x8	180	8	3888	P 220x8	220	8	4752
P 180x10	180	10	4860	P 220x10	220	10	5940
P 180x12	180	12	5832	P 220x10,3	220	10,3	6118
P 180x15	180	15	7290	P 220x15	220	15	8910
P 180x20	180	20	9720	P 220x27	220	27	16038

\* Unless otherwise indicated, profiles are made of EN AW-6060T6 alloy

\* All dimensions are expressed in mm

Via Newton, n.12  
20016 Pero (Milano - Italy)

Tel. +39 02 3535955 r.a. Fax. +39 02 3539929  
E-Mail: info@omar-alluminio.it

Cataloghi Online: [www.omar-alluminio.it](http://www.omar-alluminio.it)

[www.omar-alluminio.com](http://www.omar-alluminio.com)

CUSTOM ALUMINUM PROFILES / STANDARD / SPECIAL / AND FOR:  
ELECTRONICS / LED / PHOTOVOLTAIC / ROBOTIC AUTOMATION / PNEUMATICS / AUTOMOTIVE



For more sizes of aluminum plates  
visit the site:

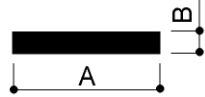

[www.piatti-alluminio.it](http://www.piatti-alluminio.it)

## FLAT BARS

BARRE PIATTE	A	B	GR/MT	BARRE PIATTE	A	B	GR/MT
P 224x25,5	224	25,5	15420	P 300x8	300	8	6480
P 225x11	225	11	6683	P 300x10	300	10	8097
P 228x140	228	140	86200	P 300x12	300	12	9720
P 230x3	230	3	1863	P 300x14	300	14	11340
P 230x12	230	12	7452	P 300x15	300	15	12195
P 230x15	230	15	9315	P 300x20	300	20	16199
P 230x19	230	19	11797	P 300x25	300	25	20249
P 230x20	230	20	12420	P 300x30	300	30	24300
P 230x25	230	25	15525	P 300x35	300	35	28350
P 230x35	230	35	21735	P 300x40	300	40	32400
P 230x70	230	70	43470	P 300x45	300	45	36450
P 230x100	230	100	62100	P 300x50	300	50	40500
P 234,4x19	234,4	19	12023	P 300x60	300	60	48600
P 237x15	237	15	9599	P 300x70	300	70	56700
P 246x8	246	8	5313	P 300x80	300	80	64800
P 250x6	250	6	4050	P 300x100	300	100	81000
P 250x8	250	8	5400	P 310x6	310	6	5022
P 250x10	250	10	6750	P 310x25	310	25	20930
P 250x12	250	12	8100	P 310x30	310	30	25110
P 250x15	250	15	10125	P 310x35	310	35	29300
P 250x20	250	20	13500	P 310x40	310	40	33480
P 250x25	250	25	16875	P 310x45	310	45	37670
P 250x30	250	30	20250	P 310x50	310	50	42000
P 250x40	250	40	27000	P 310x55	310	55	46040
P 250x45	250	45	30380	P 310x60	310	60	50500
P 250x50	250	50	33750	P 310x65	310	65	54410
P 250x60	250	60	40500	P 310x70	310	70	58590
P 250x70	250	70	47250	P 310x75	310	75	62780
P 250x80	250	80	54000	P 310x80	310	80	66960
P 250x100	250	100	67500	P 310x85	310	85	71150
P 260x25	260	25	17550	P 310x90	310	90	75330
P 260x80	260	80	56200	P 310x100	310	100	83700
P 270x50	270	50	36450	P 310x110	310	110	92070
P 280x10	280	10	7560	P 330x70	330	70	62370
P 280x30	280	30	22680	P 330x38	330	38	33858
P 280x40	280	40	30240	P 330x80	330	80	71280
P 280x45	280	45	34020	P 335x10	335	10	9045
P 280x50	280	50	37800	P 335x15	335	15	13568
P 280x60	280	60	45360	P 340x5	340	5	4590
P 280x70	280	70	52920	P 340x8	340	8	7344
P 280x80	280	80	60480	P 350x20	350	20	18900
P 280x100	280	100	76600	P 380x15	380	15	15400
P 285x12	285	12	9234	P 410x15	410	15	16600
P 285x20	285	20	15390	P 419x31	419	31	~33800
P 300x5	300	5	4050				

\* Unless otherwise indicated, profiles are made of EN AW-6060T6 alloy

\* All dimensions are expressed in mm



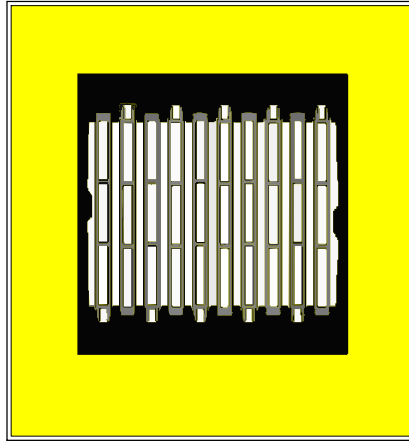

Pdf catalog of high efficiency heat sinks:  
[www.dissipatori.com](http://www.dissipatori.com)

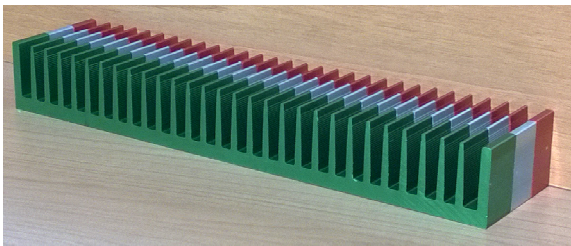

EXAMPLE PHOTO: EXTRUDED ALUMINUM PROFILES  
FLAT HEAT SINKS

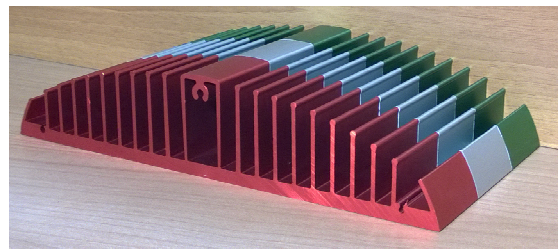

EXAMPLE PHOTO: EXTRUDED ALUMINUM PROFILES  
CUSTOM FLAT HEAT SINKS

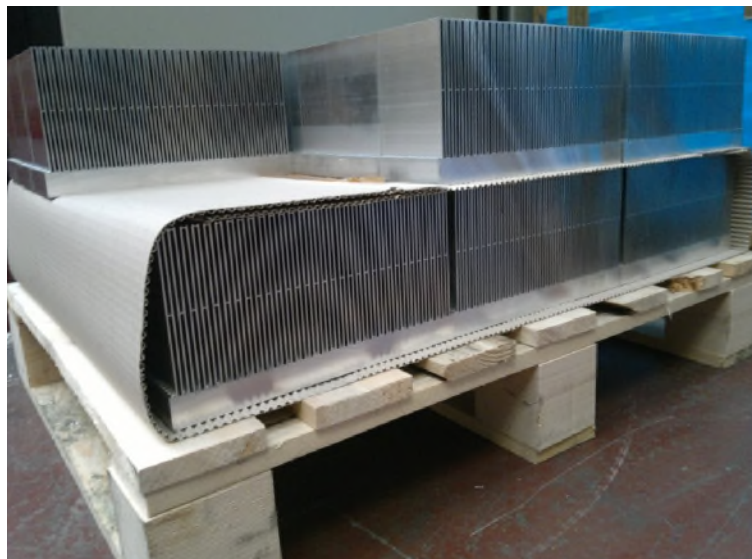

SAMPLE PHOTO: ASSEMBLED HEAT SINKS WITH HIGH  
DISPIANT PERFORMANCE

Via Newton, n.12  
20016 Pero (Milano - Italy)  
Tel. +39 02 3535955 r.a. Fax. +39 02 3539929  
E-Mail: [info@omar-alluminio.it](mailto:info@omar-alluminio.it)

Cataloghi Online: [www.omar-alluminio.it](http://www.omar-alluminio.it)  
[www.omar-alluminio.com](http://www.omar-alluminio.com)

CUSTOM ALUMINUM PROFILES / STANDARD / SPECIAL / AND FOR:  
ELECTRONICS / LED / PHOTOVOLTAIC / ROBOTIC AUTOMATION / PNEUMATICS / AUTOMOTIVE

For more sizes of aluminum radii plates,  
visit the site:

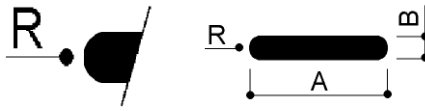

[www.piatti-alluminio.it](http://www.piatti-alluminio.it)

## RADIATED PLATES

PIATTI RAGGIATI	A	B	R	GR/MT	PIATTI RAGGIATI	A	B	R	GR/MT
PR 10x2,2x1,1	10	2,2	1,1	57	PR 30x3,3x1,65	30	3,3	1,65	262
PR 11x7x3,5	11	7	3,5	180	PR 30x3,5x1,75	30	3,5	1,75	289
PR 12x2x1	12	2	1	62	PR 30x3,6x1,8	30	3,6	1,8	284
PR 12x2,5x1,25	12	2,5	1,25	77	PR 30x3,75x1,875	30	3,75	1,875	296
PR 12x3x1,5	12	3	1,5	92	PR 30x3,8x1,90	30	3,8	1,9	299
PR 12x4x2	12	4	2	120	PR 30x4x2	30	4	2	315
PR 12x6x3	12	6	3	173	PR 30x4,5x2,25	30	4,5	2,25	353
PR 12,7x3x1,5	12,7	3	1,5	97	PR 30x4,6x2,3	30	4,6	2,3	360
PR 15x1x0,5	15	1	0,5	40	PR 30x4,75x2,375	30	4,75	2,375	373
PR 15x2x1	15	2	1	77	PR 30x5x2,5	30	5	2,5	390
PR 15x3x1,5	15	3	1,5	116	PR 30x5,5x2,75	30	5,5	2,75	428
PR 15x5x2,5	15	5	2,5	188	PR 30x6x3	30	6	3	465
PR 16x2,5x1,25	16	2,5	1,25	108	PR 30x6,5x3,25	30	6,5	3,25	503
PR 17x2,5x1,25	17	2,5	1,25	110	PR 30x7x3,5	30	7	3,5	538
PR 17x3,5x1,75	17	3,5	1,75	156	PR 30x7,5x3,75	30	7,5	3,75	575
PR 18x3x1,5	18	3	1,5	141	PR 30x10x5	30	10	5	750
PR 18x4x2	18	4	2	194	PR 30x14x7	30	14	7	1020
PR 18x9x4,5	18	9	4,5	390	PR 32x3x1,5	32	3	1,5	254
PR 18,5x5,5x2,75	18,5	5,5	2,75	257	PR 32x6x3	32	6	3	497
PR 20x1,5x0,75	20	1,5	0,75	80	PR 32x8x4	32	8	4	654
PR 20x2x1	20	2	1	108	PR 34x6,9x3,45	34	6,9	3,45	606
PR 20x3x1,5	20	3	1,5	157	PR 35x3x1,5	35	3	1,5	280
PR 20x3,5x1,75	20	3,5	1,75	182	PR 35x4x2	35	4	2	368
PR 20x4x2	20	4	2	207	PR 35x6x3	35	6	3	546
PR 20x4,1x2,05	20	4,1	2,05	211	PR 35x7,5x3,75	35	7,5	3,75	676
PR 20x5x2,5	20	5	2,5	255	PR 35x10x5	35	10	5	888
PR 20x5,8x2,9	20	5,8	2,9	294	PR 38x3x1,5	38	3	1,5	303
PR 20x6x3	20	6	3	303	PR 40x2x1	40	2	1	214
PR 20x8x4	20	8	4	395	PR 40x2,7x1,35	40	2,7	1,35	287
PR 21,5x6x3	21,5	6	3	330	PR 40x2,8x1,4	40	2,8	1,4	298
PR 22x4x2	22	4	2	230	PR 40x3x1,5	40	3	1,5	319
PR 23x14x7	23	14	7	756	PR 40x3,6x1,8	40	3,6	1,8	381
PR 24x4,1x2,05	24	4,1	2,05	257	PR 40x3,8x1,9	40	3,8	1,9	402
PR 24,9x6x3	24,9	6	3	383	PR 40x4x2	40	4	2	423
PR 25x2,7x1,35	25	2,7	1,35	178	PR 40x5x2,5	40	5	2,5	525
PR 25x3x1,5	25	3	1,5	197	PR 40x7x3,5	40	7	3,5	728
PR 25x3,6x1,8	25	3,6	1,8	235	PR 40x8x4	40	8	4	827
PR 25x4x2	25	4	2	260	PR 40x10x5	40	10	5	1021
PR 25x4,5x2,25	25	4,5	2,25	292	PR 40x15x7,5	40	15	7,5	1489
PR 25x5x2,5	25	5	2,5	323	PR 40x20x10	40	20	10	1999
PR 25x6x3	25	6	3	384	PR 47,5x7,5x3,75	47,5	7,5	3,75	932
PR 25x8x4	25	8	4	503	PR 50x1,2x0,6	50	1,2	0,6	163
PR 25x10x5	25	10	5	617	PR 50x4x2	50	4	2	531
PR 26x5,9x2,95	26	5,9	2,95	394	PR 50x5x2,5	50	5	2,5	660
PR 30x2x1	30	2	1	163	PR 50x5,9x2,95	50	5,9	2,95	776
PR 30x2,2x1,1	30	2,2	1,1	176	PR 50x6x3	50	6	3	789
PR 30x2,3x1,15	30	2,3	1,15	183	PR 50x6,9x3,45	50	6,9	3,45	904
PR 30x2,8x1,4	30	2,8	1,4	222	PR 50x7x3,5	50	7	3,5	917
PR 30x3x1,5	30	3	1,5	238	PR 50x8x4	50	8	4	1043

\* Unless otherwise indicated, profiles are made of EN AW-6060T6 alloy

\* All dimensions are expressed in mm

For more sizes of aluminum radii plates,  
visit the site:

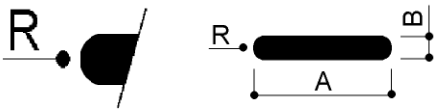

[www.piatti-alluminio.it](http://www.piatti-alluminio.it)  
**RADIATED PLATES**

PIATTI RAGGIATI	A	B	R	GR/MT	PIATTI RAGGIATI	A	B	R	GR/MT
PR 50x10x5	50	10	5	1292	PR 100x8x4	100	8	4	2123
PR 50x12x6	50	12	6	1539	PR 100x10x5	100	10	5	2642
PR 50x25x12,5	50	25	12,5	3013	PR 100x12x6	100	12	6	3156
PR 60x2x1	60	2	1	321	PR 100x13x6,5	100	13	6,5	3411
PR 60x3x1,5	60	3	1,5	481	PR 100x15x7,5	100	15	7,5	3919
PR 60x3,4x1,7	60	3,4	1,7	544	PR 101x3x1,5	101	3	1,5	818
PR 60x3,5x1,75	60	3,5	1,75	560	PR 109x2,5x1,25	109	2,5	1,25	731
PR 60x5x2,5	60	5	2,5	795	PR 110x5,25x2,625	110	5,25	2,625	1545
PR 60x5,5x2,75	60	5,5	2,75	873	PR 110x5,5x2,75	110	5,5	2,75	1618
PR 60x6x3	60	6	3	951	PR 110x6x3	110	6	3	1761
PR 60x7x3,5	60	7	3,5	1106	PR 111x6,45x3,225	111	6,45	3,225	1908
PR 60x8x4	60	8	4	1259	PR 120x5,25x2,625	120	5,25	2,625	1688
PR 60x10x5	60	10	5	1569	PR 120x6x3	120	6	3	1923
PR 60x12x6	60	12	6	1861	PR 120x8x4	120	8	4	2555
PR 60x13x6,5	60	13	6,5	2007	PR 120x9x4,5	120	9	4,5	2369
PR 63x12x6	63	12	6	1958	PR 120x10x5	120	10	5	3195
PR 65x30x15	65	30	15	5265	PR 120x12x6	120	12	6	3804
PR 67x29,5x14,75	67	29,5	14,75	5337	PR 120x15x7,5	120	15	7,5	4729
PR 70x3x1,5	70	3	1,5	562	PR 125x3x1,5	125	3	1,5	1007
PR 70x10x5	70	10	5	1832	PR 130x5,7x2,85	130	5,7	2,85	~2000
PR 70x30x15	75	30	15	5148	PR 130x6,9x3,45	130	6,9	3,45	2394
PR 75x5,75x2,875	75	5,75	2,875	2875	PR 140x12x6	140	12	6	4452
PR 75x6x3	75	6	3	1194	PR 140x15x7,5	140	15	7,5	5539
PR 75x6,45x3,225	75	6,45	3,225	1282	PR 150x6,45x3,225	150	6,45	3,225	2588
PR 75x6,9x3,45	75	6,9	3,45	1370	PR 150x10x5	150	10	5	3992
PR 75x7x3,5	75	7	3,5	1390	PR 150x12x6	150	12	6	4777
PR 75x12x6	75	12	6	2347	PR 150x15x7,5	150	15	7,5	5944
PR 76,5x6,35x3,175	76,5	6,35	3,175	1288	PR 160x5,5x2,75	160	5,5	2,75	2360
PR 80x5x2,5	80	5	2,5	1065	PR 160x6x3	160	6	3	2571
PR 80x6x3	80	6	3	1275	PR 160x6,5x3,25	160	6,5	3,25	2800
PR 80x8x4	80	8	4	1691	PR 160x10x5	160	10	5	4262
PR 80x10x5	80	10	5	2102	PR 160x12x6	160	12	6	5101
PR 80x13x6,5	80	13	6,5	2709	PR 160x14x7	160	14	7	5934
PR 85x2,5x1,25	85	2,5	1,25	570	PR 165x3x1,5	165	3	1,5	1331
PR 85x5,5x2,75	85	5,5	2,75	~1150	PR 175x6,45x3,225	175	6,45	3,225	3025
PR 90x3x1,5	90	3	1,5	724	PR 180x5,7x2,85	180	5,7	2,85	~2500
PR 90x4x2	90	4	2	963	PR 180x5,8x2,9	180	5,8	2,9	2799
PR 90x4,7x2,5	90	4,7	2,35	1129	PR 180x6,3x3,15	180	6,3	3,15	~2900
PR 90x5x2,5	90	5	2,5	1200	PR 190x6x3	190	6	3	3075
PR 90x6x3	90	6	3	1437	PR 195x3x1,5	195	3	1,5	1574
PR 90x7x3,5	90	7	3,5	1700	PR 200x10x5	200	10	5	5342
PR 90x8x4	90	8	4	1907	PR 200x15x7,5	200	15	7,5	7970
PR 95x5,2x2,6	95	5,2	2,6	~1280	PR 210x3x1,5	210	3	1,5	1695
PR 100x3,5x1,75	100	3,5	1,75	938	PR 210x6x3	210	6	3	3381
PR 100x5x2,5	100	5	2,5	1335	PR 210x6,5x3,25	210	6,5	3,25	3680
PR 100x5,25x2,625	100	5,25	2,625	1401	PR 250x15x7,5	250	15	7,5	9995
PR 100x6x3	100	6	3	1599	PR 270x10x5	270	10	5	7232
PR 100x6,45x3,225	100	6,45	3,225	1714	PR 300x10x5	300	10	5	8042
PR 100x6,9x3,45	100	6,9	3,45	1835	PR 400x10x5	400	10	5	10742

\* Unless otherwise indicated, profiles are made of EN AW-6060T6 alloy

\* All dimensions are expressed in mm

Via Newton, n.12

20016 Pero (Milano - Italy)

Tel. +39 02 3535955 r.a. Fax. +39 02 3539929

E-Mail: info@omar-alluminio.it

Cataloghi Online: [www.omar-alluminio.it](http://www.omar-alluminio.it)

[www.omar-alluminio.com](http://www.omar-alluminio.com)

CUSTOM ALUMINUM PROFILES / STANDARD / SPECIAL / AND FOR:

ELECTRONICS / LED / PHOTOVOLTAIC / ROBOTIC AUTOMATION / PNEUMATICS / AUTOMOTIVE

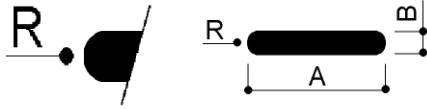

For more sizes of aluminum radii plates,  
visit the site:

[www.piatti-alluminio.it](http://www.piatti-alluminio.it)

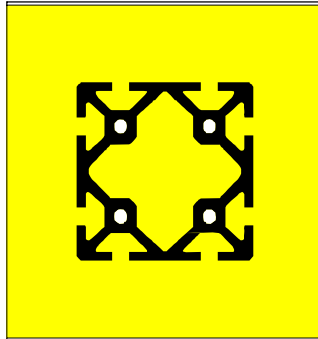

Pdf catalog modular profiles  
(structural aluminum profiles  
for benches and modular lines  
for mechatronics, for linear movements  
and packaging machines,  
robotics profiles and related joining accessories):

[www.robotica.sm](http://www.robotica.sm)

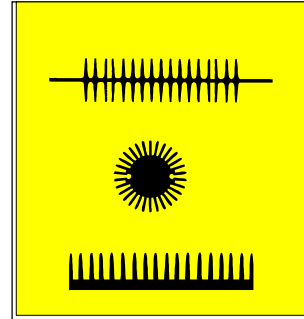

Pdf catalog heat sinks  
(flat sinks / round sinks  
cooling fins / peltier cells  
cut / drilled / anodized sinks etc.):  
[www.dissipatori.com](http://www.dissipatori.com)

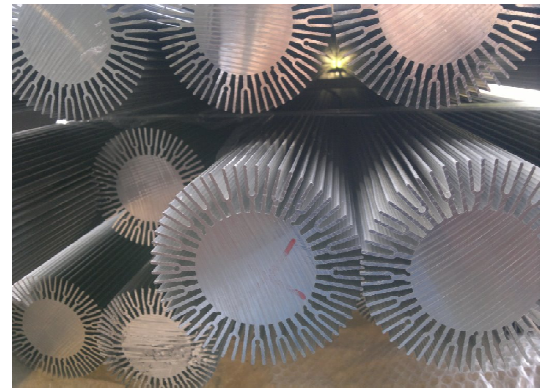

EXAMPLE PHOTO: LARGE DOUBLE COMB HEAT SINKS

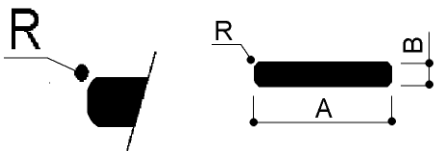

For more sizes of aluminum rounded edge plates, please visit:

[www.piatti-alluminio.it](http://www.piatti-alluminio.it)

## PLATES WITH ROUNDED EDGES

PIATTI A SPIGOLI ARROTONDATI	A	B	R	GR/MT	PIATTI A SPIGOLI ARROTONDATI	A	B	R	GR/MT
PSA 8x2x0,5	8	2	0,5	30	PSA 20x12x1	20	12	1	646
PSA 9x5x0,5	9	5	0,5	118	PSA 20x12x1,5	20	12	1,5	643
PSA 9x5,5X1	9	5,5	1	131	PSA 20x15x0,8	20	15	0,8	810
PSA 10x2x0,5	10	2	0,5	53	PSA 20x15x1	20	15	1	810
PSA 10x4x1	10	4	1	100	PSA 20x15x2	20	15	2	302
PSA 10x5x0,3	10	5	0,3	135	PSA 21x3x1	21	3	1	168
PSA 10x6x0,5	10	6	0,5	161	PSA 21,5x16x1	21,5	16	1	926
PSA 10,8x7x1	10,8	7	1	201	PSA 22x10x1	22	10	1	594
PSA 11x8x0,6	11	8	0,6	237	PSA 22,5x3,4	22,5	3,4	3,4	199
PSA 12x2	12	2		60	PSA 23x2	23	2		121
PSA 12x2x0,25	12	2	0,25	65	PSA 23x3	23	3		180
PSA 12x2,5	12	2,5		77	PSA 25x3,2	25	3,2		207
PSA 12x3	12	3		89	PSA 25x3,5	25	3,5		226
PSA 12x4	12	4		120	PSA 25x3,7	25	3,7		241
PSA 12x4x0,3	12	4	0,3	129	PSA 25x4x1,3	25	4	1,3	270
PSA 13x7x1,5	13	7	1,5	240	PSA 25x5x1	25	5	1	337
PSA 13x6,5x0,3	13	6,5	0,3	228	PSA 25x6x0,5	25	6	0,5	405
PSA 13x8x0,3	13	8	0,3	281	PSA 25x6x0,7	25	6	0,7	405
PSA 13x8x1	13	8	1	279	PSA 25x8x0,5	25	8	0,5	540
PSA 15x2x0,25	15	2	0,25	81	PSA 25x8x0,8	25	8	0,8	540
PSA 15x2x0,75	15	2	0,75	78	PSA 25x8x1	25	8	1	540
PSA 15x3	15	3		116	PSA 25x10x0,5	25	10	0,5	675
PSA 15x5x1	15	5	1	200	PSA 25x10x0,8	25	10	0,8	675
PSA 15x8x1	15	8	1	322	PSA 25x10x1	25	10	1	675
PSA 15x10x0,5	15	10	0,5	404	PSA 25x12x0,8	25	12	0,8	875
PSA 16x5x0,5	15	5	0,5	216	PSA 25x12x1	25	12	1	810
PSA 16x3	16	3		124	PSA 25x12x2	25	12	2	800
PSA 17x8x0,3	17	8	0,3	367	PSA 25x15x0,8	25	15	0,8	1013
PSA 17,8x6x0,3	17,8	6	0,3	286	PSA 25x15x1	25	15	1	1015
PSA 18x3x0,3	18	3	0,3	146	PSA 25x16x1	25	16	1	1080
PSA 18x8x1	18	8	1	386	PSA 25x16x2	25	16	2	1071
PSA 19,8x5x0,5	19,8	5	0,5	268	PSA 25x20x0,8	25	20	0,8	1350
PSA 20x2	20	2		105	PSA 25x20x1	25	20	1	1350
PSA 20x2x0,75	20	2	0,75	105	PSA 25,6x15,6x1	25,6	15,6	1	1058
PSA 20x3	20	3		160	PSA 26x3	26	3		208
PSA 20x3x0,3	20	3	0,3	162	PSA 26,7x11,7x0,5	26,7	11,7	0,5	843
PSA 20x3,5	20	3,5		181	PSA 27,7x14,7x0,5	27,7	14,7	0,5	1096
PSA 20x3,8	20	3,8		196	PSA 28x3x0,3	28	3	0,3	227
PSA 20x4x1,5	20	4	1,5	213	PSA 28x7x1,5	28	7	1,5	524
PSA 20x4,4x0,5	20	4,4	0,5	237	PSA 28x25x2	28	25	2	1881
PSA 20x5x0,3	20	5	0,3	270	PSA 28x25x4	28	25	4	1853
PSA 20x5x0,4	20	5	0,4	267	PSA 28,7x14,2x0,5	28,7	14,2	0,5	1100
PSA 20x6x0,5	20	6	0,5	324	PSA 30x2x1,1	30	2	1,1	175
PSA 20x8x1	20	8	1	432	PSA 30x2,5x0,6	30	2,5	0,6	203
PSA 20x10x0,5	20	10	0,5	540	PSA 30x3	30	3		237
PSA 20x10x0,75	20	10	0,75	540	PSA 30x3x0,3	30	3	0,3	243
PSA 20x10x0,8	20	10	0,8	540	PSA 30x3,6x1,6	30	3,6	1,6	283
PSA 20x10x1	20	10	1	537	PSA 30x3,8	30	3,8		299

\* Unless otherwise indicated, profiles are made of EN AW-6060T6 alloy

\* All dimensions are expressed in mm

Via Newton, n.12

20016 Pero (Milano - Italy)

Tel. +39 02 3535955 r.a. Fax. +39 02 3539929

E-Mail: [info@omar-alluminio.it](mailto:info@omar-alluminio.it)

Cataloghi Online: [www.omar-alluminio.it](http://www.omar-alluminio.it)

[www.omar-alluminio.com](http://www.omar-alluminio.com)

CUSTOM ALUMINUM PROFILES / STANDARD / SPECIAL / AND FOR:

ELECTRONICS / LED / PHOTOVOLTAIC / ROBOTIC AUTOMATION / PNEUMATICS / AUTOMOTIVE

**omar** s.r.l.  
PROFILATI ALLUMINIO  
ALTA TECNOLOGIA



For more sizes of aluminum rounded edge plates, please visit:

[www.piatti-alluminio.it](http://www.piatti-alluminio.it)

## PLATES WITH ROUNDED EDGES

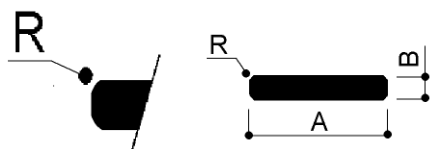

PIATTI A SPIGOLI ARROTONDATI	A	B	R	GR/MT	PIATTI A SPIGOLI ARROTONDATI	A	B	R	GR/MT
PSA 30x4	30	4		313	PSA 35x25x1	35	25	1	2363
PSA 30x4x1,5	30	4	1,5	319	PSA 35x30x1	35	30	1	2835
PSA 30x4,4	30	4,4		342	PSA 35x30x1,5	35	30	1,5	2830
PSA 30x5	30	5		390	PSA 36x6,7x1	36	6,7	1	651
PSA 30x5x0,5	30	5	0,5	405	PSA 36x18x1	36	18	1	1750
PSA 30x5x0,8	30	5	0,8	405	PSA 36,3x25,25x0,8	36,3	25,25	0,8	2475
PSA 30x5,5	30	5,5		427	PSA 38x6,35x1	38	35	1	649
PSA 30x6x0,5	30	6	0,5	485	PSA 38x22x1	38	22	1	2257
PSA 30x6x1	30	6	1	486	PSA 40x2,8	40	2,8		297
PSA 30x8x0,5	30	8	0,5	648	PSA 40x3	40	3		318
PSA 30x8x0,8	30	8	0,8	648	PSA 40x3x1	40	3	1	320
PSA 30x8x1	30	8	1	640	PSA 40x3,5	40	3,5		369
PSA 30x10x0,3	30	10	0,3	810	PSA 40x3,6	40	3,6		380
PSA 30x10x0,6	30	10	0,6	810	PSA 40x3,6x1,6	40	3,6	1,6	384
PSA 30x10x0,8	30	10	0,8	810	PSA 40x3,8	40	3,8		390
PSA 30x10x1	30	10	1	807	PSA 40x4	40	4		421
PSA 30x12x0,8	30	12	0,8	972	PSA 40x4x1	40	4	1	430
PSA 30x12x1	30	12	1	972	PSA 40x5x0,8	40	5	0,8	540
PSA 30x12x1,5	30	12	1,5	967	PSA 40x5x1	40	5	1	540
PSA 30x15x0,8	30	15	0,8	1215	PSA 40x5,5x1,5	40	5,5	1,5	~560
PSA 30x15x1	30	15	1	1215	PSA 40x6x0,5	40	6	0,5	648
PSA 30x15x2	30	15	2	1207	PSA 40x6x0,8	40	6	0,8	648
PSA 30x15x4	30	15	4	1178	PSA 40x6x1	40	6	1	648
PSA 30x20x0,5	30	20	0,5	1620	PSA 40x8	40	8		826
PSA 30x20x0,8	30	20	0,8	1620	PSA 40x8x0,3	40	8	0,3	861
PSA 30x20x1	30	20	1	1620	PSA 40x8x0,5	40	8	0,5	864
PSA 30x20x4	30	20	4	1583	PSA 40x8x0,8	40	8	0,8	864
PSA 30x25x1	30	25	1	2025	PSA 40x8x1	40	8	1	827
PSA 30x25x6	30	25	6	1942	PSA 40x10x0,6	40	10	0,6	1079
PSA 30,5x25,5x0,8	30,5	25,5	0,8	2100	PSA 40x10x0,8	40	10	0,8	1080
PSA 31,15x5x0,6	31,15	5	0,6	420	PSA 40x10x1	40	10	1	1077
PSA 31,75x25,4x1	31,75	25,4	1	2177	PSA 40x10x1,5	40	10	1,5	1075
PSA 32x8x2	32	8	2	682	PSA 40x10x4	40	10	4	1042
PSA 32x18x1	32	18	1	1555	PSA 40x12x0,5	40	12	0,5	1296
PSA 32x22x1	32	22	1	1901	PSA 40x12x0,8	40	12	0,8	1296
PSA 32x22x1,5	32	22	1,5	1971	PSA 40x12x1	40	12	1	1300
PSA 32,5x10,4x1	32,5	10,4	1	913	PSA 40x12x1,5	40	12	1,5	1296
PSA 33x2x0,3	33	2	0,3	178	PSA 40x15x0,8	40	15	0,8	1620
PSA 33x23x1	33	23	1	2047	PSA 40x15x1	40	15	1	1620
PSA 33x26,3x1,3	33	26,3	1,3	2339	PSA 40x20x1	40	20	1	2484
PSA 35x5x0,5	35	5	0,5	473	PSA 40x20x5	40	20	5	2105
PSA 35x8x1	35	8	1	756	PSA 40x23x1	40	23	1	2484
PSA 35x10x0,5	35	10	0,5	945	PSA 40x25x1	40	25	1	2700
PSA 35x10x1	35	10	1	945	PSA 40x26x1	40	26	1	2816
PSA 35x15x0,8	35	15	0,8	1418	PSA 40x27x0,5	40	27	0,5	2915
PSA 35x15x1	35	15	1	1420	PSA 40x28x1	40	28	1	3024
PSA 35x16,5x1	35	16,5	1	1557	PSA 40x30x1	40	30	1	3240
PSA 35x20x1	35	20	1	1890	PSA 40x30x1,5	40	30	1,5	3240

\* Unless otherwise indicated, profiles are made of EN AW-6060T6 alloy

\* All dimensions are expressed in mm

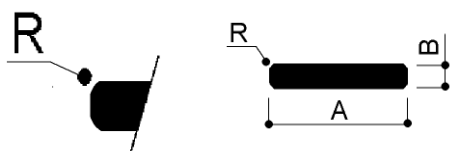

For more sizes of aluminum rounded edge plates, please visit:

[www.piatti-alluminio.it](http://www.piatti-alluminio.it)

## PLATES WITH ROUNDED EDGES

PIATTI A SPIGOLI ARROTONDATI	A	B	R	GR/MT	PIATTI A SPIGOLI ARROTONDATI	A	B	R	GR/MT
PSA 40x35x0,8	40	35	0,8	3780	PSA 50x10x0,6	50	10	0,6	1350
PSA 40x35x1	40	35	1	3780	PSA 50x10x0,8	50	10	0,8	1350
PSA 40x35x1,8	40	35	1,8	3780	PSA 50x10x1	50	10	1	1347
PSA 40x35x2	40	35	2	3771	PSA 50x12x0,6	50	12	0,6	1618
PSA 40,3x26,3x1	40,3	26,3	1	~2700	PSA 50x12x0,8	50	12	0,8	1620
PSA 41x2x0,5	41	2	0,5	221	PSA 50x12x0,9	50	12	0,9	1617
PSA 41,15x31,75x1,8	41,15	31,75	1,8	3528	PSA 50x12x1	50	12	1	1620
PSA 42x2,5x0,5	42	2,5	0,5	289	PSA 50x15x0,8	50	15	0,8	2025
PSA 42x5x1	42	5	1	564	PSA 50x15x1	50	15	1	2025
PSA 42x15x1	42	15	1	1696	PSA 50x20x0,8	50	20	0,8	2700
PSA 42x27x2	42	27	2	3175	PSA 50x20x1	50	20	1	2700
PSA 42,5x27x3	42,5	27	3	3077	PSA 50x20x2	50	20	2	2701
PSA 43x10x2	43	10	2	1152	PSA 50x25x0,8	50	25	0,8	3375
PSA 44x16x0,5	44	16	0,5	1900	PSA 50x25x1	50	25	1	3375
PSA 44x19x0,5	44	19	0,5	2257	PSA 50x28x1	50	28	1	3780
PSA 44x24x1	44	24	1	2846	PSA 50x30x0,8	50	30	0,8	4050
PSA 44,5x25,5x2	44,5	25,5	2	3057	PSA 50x30x1	50	30	1	4050
PSA 44,45x31,75x1,8	44,45	31,75	1,8	~3600	PSA 50x30x1,5	50	30	1,5	4050
PSA 44,45x38,10x1,8	44,45	38,1	1,8	~4500	PSA 50x33x1,8	50	33	1,8	4455
PSA 45x10x0,6	45	10	0,6	1215	PSA 50x35x0,8	50	35	0,8	4725
PSA 45x10x1	45	10	1	1215	PSA 50x35x1	50	35	1	4725
PSA 45x15x0,8	45	15	0,8	1820	PSA 50x35x1,5	50	35	1,5	4725
PSA 45x15x1	45	15	1	1823	PSA 50x35x1,8	50	35	1,8	4725
PSA 45x15x4	45	15	4	1800	PSA 50x35x2,5	50	35	2,5	4725
PSA 45x16x1	45	16	1	1941	PSA 50x37x2,5	50	37	2,5	4995
PSA 45x20x0,9	45	20	0,9	2430	PSA 50x40x0,8	50	40	0,8	5400
PSA 45x20x1	45	20	1	2430	PSA 50x40x1	50	40	1	5400
PSA 45x25x1	45	25	1	3037	PSA 50x40x1,5	50	40	1,5	5400
PSA 45x30x1	45	30	1	3645	PSA 50x40x1,8	50	40	1,8	5400
PSA 45x30x1,25	45	30	1,25	3645	PSA 50x40x2,5	50	40	2,5	5400
PSA 45x35x1,5	45	35	1,5	4252	PSA 50,8x25,4x1	50,8	25,4	1	3484
PSA 45x35x1,8	45	35	1,8	4253	PSA 50,8x31,75x1,8	50,8	31,75	1,8	4355
PSA 45x37x2,5	45	37	2,5	4496	PSA 50,8x38,1x1	50,8	38,1	1	5225
PSA 46x27x1	46	27	1	3353	PSA 50,8x38,1x1,8	50,8	38,1	1,8	5226
PSA 46x38x1,8	46	38	1,8	4720	PSA 50,8x44,45x1	50,8	44,45	1	6097
PSA 49,5x29,5x2	49,5	29,5	2	3934	PSA 51x33,6x1	51	33,6	1	4627
PSA 50x3x0,8	50	3	0,8	405	PSA 51x35x1,8	51	35	1,8	4820
PSA 50x4x0,3	50	4	0,3	540	PSA 51x41x1,8	51	41	1,8	5646
PSA 50x4x0,5	50	4	0,5	540	PSA 52x30x3	52	30	3	4212
PSA 50x4x1,2	50	4	1,2	537	PSA 52x32x1	52	32	1	4493
PSA 50x5x0,5	50	5	0,5	675	PSA 52x34,6x1,8	52	34,6	1,8	4850
PSA 50x5x1	50	5	1	672	PSA 53,5x37x2,5	53,5	37	2,5	5345
PSA 50x5,5x1,5	50	5,5	1,5	737	PSA 54x31,5x1,9	54	31,5	1,9	4669
PSA 50x6x1	50	6	1	810	PSA 55x4x0,3	55	4	0,3	593
PSA 50x6,9x0,5	50	6,9	0,5	929	PSA 55x8x1	55	8	1	1188
PSA 50x8x0,5	50	8	0,5	1080	PSA 55x10x1	55	10	1	1485
PSA 50x8x0,6	50	8	0,6	1079	PSA 55x11x1	55	11	1	1631
PSA 50x8x1	50	8	1	1080	PSA 55x30x1	55	30	1	4455

\* Unless otherwise indicated, profiles are made of EN AW-6060T6 alloy

\* All dimensions are expressed in mm

Via Newton, n.12  
20016 Pero (Milano - Italy)  
Tel. +39 02 3535955 r.a. Fax. +39 02 3539929  
E-Mail: info@omar-alluminio.it

Cataloghi Online: [www.omar-alluminio.it](http://www.omar-alluminio.it)  
[www.omar-alluminio.com](http://www.omar-alluminio.com)

CUSTOM ALUMINUM PROFILES / STANDARD / SPECIAL / AND FOR:  
ELECTRONICS / LED / PHOTOVOLTAIC / ROBOTIC AUTOMATION / PNEUMATICS / AUTOMOTIVE



# Commercial Profiles- Aluminium standard sections

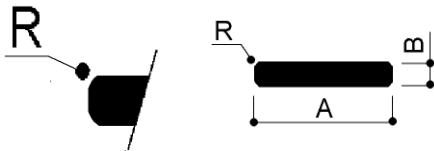

For more sizes of aluminum rounded edge plates, please visit:

[www.piatti-alluminio.it](http://www.piatti-alluminio.it)

## PLATES WITH ROUNDED EDGES

PIATTI A SPIGOLI ARROTONDATI	A	B	R	GR/MT	PIATTI A SPIGOLI ARROTONDATI	A	B	R	GR/MT
PSA 55x30x4	55	30	4	4455	PSA 60x40x1,5	60	40	1,5	6480
PSA 55x35x1,5	55	35	1,5	5192	PSA 60x40x1,8	60	40	1,8	6480
PSA 55x40x2,5	55	40	2,5	5940	PSA 60x45x1	60	45	1	7290
PSA 55x45x0,5	55	45	0,5	6682	PSA 60x45x1,8	60	45	1,8	7290
PSA 55x45x1	55	45	1	6675	PSA 60x45x3	60	45	3	7290
PSA 55,25x45,25x1	55,25	45,25	1	6747	PSA 60x50x0,5	60	50	0,5	8099
PSA 56x46x1,5	56	46	1,5	6950	PSA 60x50x0,8	60	50	0,8	8100
PSA 57x52x1	57	52	1	8003	PSA 60x50x1	60	50	1	8100
PSA 57,15x31,75x1,8	57,15	31,75	1,8	~4700	PSA 60x50x1,5	60	50	1,5	8100
PSA 60x2	60	2		321	PSA 60x50x1,8	60	50	1,8	8100
PSA 60x2,5	60	2,5		399	PSA 60x55x2	60	55	2	8910
PSA 60x3,4	60	3,4		542	PSA 60,3x25,4x1	60,3	25,4	1	4134
PSA 60x4x0,5	60	4	0,5	648	PSA 60,5x50,5x1,8	60,5	50,5	1,8	8242
PSA 60x4x1	60	4	1	648	PSA 61x31x1,5	61	31	1,5	5100
PSA 60x4,5	60	4,5		715	PSA 62x6x1	62	6	1	1001
PSA 60x5x1	60	5	1	810	PSA 62x32x2,5	62	32	2,5	5357
PSA 60x5,75	60	5,75		909	PSA 62x40x1	62	40	1	6696
PSA 60x6	60	6		950	PSA 62x45x1	62	45	1	7531
PSA 60x6x0,8	60	6	0,8	972	PSA 62x48x2,5	62	48	2,5	8035
PSA 60x6x1	60	6	1	970	PSA 62x57x2,5	62	57	2,5	9542
PSA 60x6,5x2	60	6,5	2	1045	PSA 62x60x1,8	62	60	1,8	10044
PSA 60x8x1	60	8	1	1296	PSA 63x10x0,5	63	10	0,5	1700
PSA 60x8x1,5	60	8	1,5	~1300	PSA 63x36x1,8	63	36	1,8	6124
PSA 60x10x0,5	60	10	0,5	1620	PSA 63x50x0,8	63	50	0,8	8505
PSA 60x10x1	60	10	1	1617	PSA 63x55x1,8	63	55	1,8	9356
PSA 60x12x0,8	60	12	0,8	1944	PSA 63,5x25,4x1	63,5	25,4	1	4355
PSA 60x12x0,9	60	12	0,9	1941	PSA 63,5x31,75x1	63,5	31,75	1	5444
PSA 60x12x1	60	12	1	1944	PSA 63,5x31,75x1,8	63,5	31,75	1,8	5444
PSA 60x12x1,5	60	12	1,5	1944	PSA 63,5x31,75x2,5	63,5	31,75	2,5	5444
PSA 60x15x0,5	60	15	0,5	2430	PSA 63,5x44,45x1	63,5	44,45	1	7621
PSA 60x15x0,6	60	15	0,6	2430	PSA 63,5x44,45x1,8	63,5	44,45	1,8	7621
PSA 60x15x0,8	60	15	0,8	2430	PSA 63,5x50,8x1,5	63,5	50,8	1,5	8710
PSA 60x15x1	60	15	1	2430	PSA 64x12x1,5	64	12	1,5	2074
PSA 60x15x3	60	15	3	2421	PSA 64x12,5x0,4	64	12,5	0,4	2160
PSA 60x20x0,8	60	20	0,8	3240	PSA 64,5x23,5x0,4	64,5	23,5	0,4	4093
PSA 60x20x1	60	20	1	3240	PSA 65x10x0,5	65	10	0,5	1754
PSA 60x25	60	25		3687	PSA 65x30x1	65	30	1	5265
PSA 60x25x0,8	60	25	0,8	4050	PSA 65x33x2	65	33	2	5792
PSA 60x25x1	60	25	1	4050	PSA 65x35x1	65	35	1	6140
PSA 60x30x1	60	30	1	4860	PSA 65x35x1,5	65	35	1,5	6137
PSA 60x30x1,5	60	30	1,5	5034	PSA 65x35x1,8	65	35	1,8	6143
PSA 60x30x2	60	30	2	4852	PSA 65x40x1	65	40	1	7020
PSA 60x31x1	60	31	1	5019	PSA 65x40x1,8	65	40	1,8	7020
PSA 60x35x1,5	60	35	1,5	5874	PSA 65x45x1	65	45	1	7898
PSA 60x35x1,8	60	35	1,8	5670	PSA 65x45x1,8	65	45	1,8	7898
PSA 60x40x0,8	60	40	0,8	6480	PSA 65x50x1	65	50	1	8775
PSA 60x40x1	60	40	1	6500	PSA 66x50,5x1	66	50,5	1	8999
PSA 60x40x1,2	60	40	1,2	6477	PSA 66x60x2,5	66	60	2,5	10692

\* Unless otherwise indicated, profiles are made of EN AW-6060T6 alloy

\* All dimensions are expressed in mm



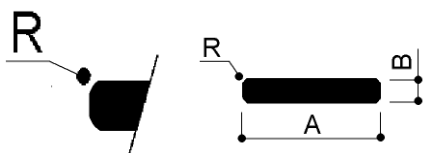

For more sizes of aluminum rounded edge plates, please visit:

[www.piatti-alluminio.it](http://www.piatti-alluminio.it)

## PLATES WITH ROUNDED EDGES

PIATTI A SPIGOLI ARROTONDATI	A	B	R	GR/MT	PIATTI A SPIGOLI ARROTONDATI	A	B	R	GR/MT
PSA 66,9x63,5x1	66,9	63,5	1	15239	PSA 75x15x1	75	15	1	3032
PSA 67x30x1	67	30	1	5425	PSA 75x25,4x1	75	25,4	1	5144
PSA 68x52x1,8	68	52	1,8	9547	PSA 75x32x1,8	75	32	1,8	6480
PSA 70x4x0,5	70	4	0,5	756	PSA 75x35x1,8	75	35	1,8	7088
PSA 70x6x0,5	70	6	0,5	1133	PSA 75x40x1,8	75	40	1,8	8100
PSA 70x8x0,5	70	8	0,5	1511	PSA 75x50x2,5	75	50	2,5	10125
PSA 70x8x0,6	70	8	0,6	1512	PSA 75x55x1,8	75	55	1,8	11138
PSA 70x10x0,6	70	10	0,6	1890	PSA 75x65x1,8	75	65	1,8	13163
PSA 70x10x0,8	70	10	0,8	1890	PSA 75x71x1	75	71	1	14375
PSA 70x10x1	70	10	1	1820	PSA 75x71x1,7	75	71	1,7	14369
PSA 70x12x1	70	12	1	2268	PSA 75x71x1,8	75	71	1,8	14378
PSA 70x15x0,8	70	15	0,8	2835	PSA 76x28x1	76	28	1	5746
PSA 70x15x1	70	15	1	2835	PSA 76x35x1	76	35	1	7182
PSA 70x15x1,5	70	15	1,5	2830	PSA 76x65x2,5	76	65	2,5	13338
PSA 70x20x1	70	20	1	3780	PSA 76,2x19,05x1	76,2	19,05	1	3919
PSA 70x25x1	70	25	1	4725	PSA 76,2x25,4x1	76,2	25,4	1	5226
PSA 70x25,5x1,5	70	25,5	1,5	4820	PSA 76,2x31,75x1	76,2	31,75	1	6532
PSA 70x30x0,8	70	30	0,8	5670	PSA 76,2x31,75x1,8	76,2	31,75	1,8	6532
PSA 70x30x1	70	30	1	5670	PSA 76,2x38,1x1	76,2	38,1	1	7839
PSA 70x32x1,5	70	32	1,5	6048	PSA 76,2x38,1x1,8	76,2	38,1	1,8	7839
PSA 70x35x1	70	35	1	6613	PSA 76,2x44,45x1	76,2	44,45	1	9145
PSA 70x35x1,5	70	35	1,5	6854	PSA 76,2x44,45x1,8	76,2	44,45	1,8	9145
PSA 70x35x1,8	70	35	1,8	6615	PSA 76,2x50,8x0,5	76,2	50,8	0,5	10452
PSA 70x40x1	70	40	1	7560	PSA 76,2x50,8x1,8	76,2	50,8	1,8	10452
PSA 70x40x1,5	70	40	1,5	7560	PSA 76,2x57,15x1,8	76,2	57,15	1,8	11758
PSA 70x40x1,8	70	40	1,8	7560	PSA 76,2x63,5x1,8	76,2	63,5	1,8	13064
PSA 70x45x1,8	70	45	1,8	8505	PSA 77x43x1	77	43	1	8940
PSA 70x50x1	70	50	1	9448	PSA 79x4x0,5	79	4	0,5	853
PSA 70x50x1,5	70	50	1,5	9450	PSA 79,63x31x1	79,63	31	1	6665
PSA 70x50x1,8	70	50	1,8	9450	PSA 80x4,5	80	4,5		958
PSA 70x55x1	70	55	1	10395	PSA 80x5	80	5		1063
PSA 70x55x1,8	70	55	1,8	10395	PSA 80x5x0,5	80	5	0,5	1080
PSA 70x60x0,5	70	60	0,5	11339	PSA 80x5x1	80	5	1	1080
PSA 70x60x1,8	70	60	1,8	11340	PSA 80x5,75	80	5,75		1220
PSA 70,5x60,5x1,8	70,5	60,5	1,8	11509	PSA 80x6	80	6		1274
PSA 71x40x1,8	71	40	1,8	7668	PSA 80x6x0,4	80	6	0,4	1296
PSA 72x5x0,5	72	5	0,5	972	PSA 80x6x0,7	80	6	0,7	1296
PSA 72x6x1	72	6	1	1163	PSA 80x6x1	80	6	1	1293
PSA 72x6,5x1,5	72	6,5	1,5	1261	PSA 80x7x1	80	7	1	1510
PSA 72x52x2,5	72	52	2,5	10109	PSA 80x8x0,5	80	8	0,5	1728
PSA 72x59x1,8	72	59	1,8	11470	PSA 80x8x1	80	8	1	1725
PSA 72x59x2	72	59	2	11470	PSA 80x8x2	80	8	2	1718
PSA 72x59x2,5	72	59	2,5	11470	PSA 80x10x0,5	80	10	0,5	2160
PSA 72x62x1	72	62	1	12050	PSA 80x10x0,6	80	10	0,6	2160
PSA 72,2x6x0,75	72,2	6	0,75	1168	PSA 80x10x0,8	80	10	0,8	2160
PSA 73x68x1,8	73	68	1,8	13403	PSA 80x10x1	80	10	1	2157
PSA 74,5x28x2	74,5	28	2	5630	PSA 80x12x0,9	80	12	0,9	2589
PSA 75x10x1	75	10	1	2025	PSA 80x12x1	80	12	1	2529

\* Unless otherwise indicated, profiles are made of EN AW-6060T6 alloy

\* All dimensions are expressed in mm

Via Newton, n.12

20016 Pero (Milano - Italy)

Tel. +39 02 3535955 r.a. Fax. +39 02 3539929

E-Mail: info@omar-alluminio.it

Cataloghi Online: [www.omar-alluminio.it](http://www.omar-alluminio.it)

[www.omar-alluminio.com](http://www.omar-alluminio.com)

CUSTOM ALUMINUM PROFILES / STANDARD / SPECIAL / AND FOR:

ELECTRONICS / LED / PHOTOVOLTAIC / ROBOTIC AUTOMATION / PNEUMATICS / AUTOMOTIVE



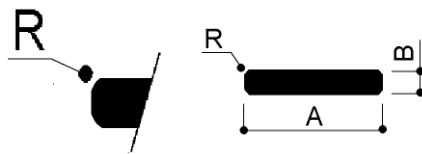

For more sizes of aluminum rounded edge plates, please visit:

[www.piatti-alluminio.it](http://www.piatti-alluminio.it)

## PLATES WITH ROUNDED EDGES

PIATTI A SPIGOLI ARROTONDATI	A	B	R	GR/MT	PIATTI A SPIGOLI ARROTONDATI	A	B	R	GR/MT
PSA 80x12x1,5	80	12	1,5	2587	PSA 86x35x1,8	86	35	1,8	8127
PSA 80x15x0,8	80	15	0,8	3240	PSA 88,55x63,5x1,8	88,55	63,5	1,8	15182
PSA 80x15x1	80	15	1	3240	PSA 88,9x15,88x1	88,9	15,88	1	3810
PSA 80x15x1,5	80	15	1,5	2651	PSA 88,9x31,75x1,8	88,9	31,75	1,8	7621
PSA 80x18x2	80	18	2	3879	PSA 88,9x38,1x1,8	88,9	38,1	1,8	9145
PSA 80x20x1	80	20	1	4320	PSA 88,9x38,1x2,5	88,9	38,1	2,5	9145
PSA 80x20x3	80	20	3	4320	PSA 88,9x50,8x1,8	88,9	50,8	1,8	12194
PSA 80x25x1	80	25	1	5400	PSA 88,9x57,15x2,5	88,9	57,15	2,5	13718
PSA 80x26,5x1	80	26,5	1	5721	PSA 88,9x63,5x1,8	88,9	63,5	1,8	15242
PSA 80x30x1	80	30	1	6478	PSA 88,9x63,5x2,5	88,9	63,5	2,5	15242
PSA 80x32x1	80	32	1	6910	PSA 88,9x69,85x1,8	88,9	69,85	1,8	16766
PSA 80x35x1	80	35	1	7558	PSA 88,9x76,2x1	88,9	76,2	1	18284
PSA 80x35x1,5	80	35	1,5	7834	PSA 88,9x76,2x1,8	88,9	76,2	1,8	18290
PSA 80x35x1,8	80	35	1,8	7560	PSA 90x1,5x0,6	90	1,5	0,6	364
PSA 80x40x1	80	40	1	8638	PSA 90x6x0,7	90	6	0,7	1458
PSA 80x40x1,5	80	40	1,5	8640	PSA 90x10x0,6	90	10	0,6	2430
PSA 80x40x1,8	80	40	1,8	8640	PSA 90x10x1	90	10	1	2430
PSA 80x45x1	80	45	1	9720	PSA 90x10x1,5	90	10	1,5	2430
PSA 80x45x1,8	80	45	1,8	9720	PSA 90x12x0,8	90	12	0,8	2913
PSA 80x50x1	80	50	1	10800	PSA 90x12x1	90	12	1	2916
PSA 80x50x1,5	80	50	1,5	10800	PSA 90x15x0,8	90	15	0,8	3645
PSA 80x50x1,8	80	50	1,8	10800	PSA 90x15x1	90	15	1	3645
PSA 80x55x1,8	80	55	1,8	11880	PSA 90x20x0,7	90	20	0,7	4859
PSA 80x60x1,8	80	60	1,8	12960	PSA 90x20x1	90	20	1	4860
PSA 80x60x2,5	80	60	2,5	12960	PSA 90x25x1	90	25	1	6075
PSA 80x65x1,8	80	65	1,8	14040	PSA 90x27x1	90	27	1	6561
PSA 80x70x1	80	70	1	15120	PSA 90x30x1	90	30	1	7290
PSA 80x70x1,8	80	70	1,8	15671	PSA 90x31x1,8	90	31	1,8	7533
PSA 80x71x1	80	71	1	16331	PSA 90x31x2,5	90	31	2,5	7533
PSA 81x61x2,5	81	61	2,5	13341	PSA 90x35x1,8	90	35	1,8	8505
PSA 82x42x2,5	82	42	2,5	9299	PSA 90x40x1	90	40	1	9720
PSA 82x52x2,5	82	52	2,5	11513	PSA 90x40x1,5	90	40	1,5	10074
PSA 82x62x2,5	82	62	2,5	13727	PSA 90x40x1,8	90	40	1,8	9720
PSA 82,55x15,9x1	82,55	15,9	1	3542	PSA 90x40x2,5	90	40	2,5	9720
PSA 82,55x31,75x1,8	82,55	31,75	1,8	7077	PSA 90x45x0,8	90	45	0,8	10935
PSA 82,55x63,5x1,8	82,55	63,5	1,8	14153	PSA 90x45x1	90	45	1	10935
PSA 83,5x50,8x1	83,5	50,8	1	11452	PSA 90x45x1,8	90	45	1,8	10935
PSA 84x72,5x2	84	72,5	2	16443	PSA 90x50x1	90	50	1	12150
PSA 85x8x0,5	85	8	0,5	1835	PSA 90x50x1,5	90	50	1,5	12150
PSA 85x10x1,5	85	10	1,5	2289	PSA 90x50x1,8	90	50	1,8	12150
PSA 85x30x1	85	30	1	6885	PSA 90x55x1,8	90	55	1,8	13365
PSA 85x40x1,5	85	40	1,5	9180	PSA 90x60x1	90	60	1	14580
PSA 85x45x1,8	85	45	1,8	10328	PSA 90x60x1,5	90	60	1,5	14568
PSA 85x50x1,8	85	50	1,8	11475	PSA 90x60x1,8	90	60	1,8	14580
PSA 85x55x2,5	85	55	2,5	12623	PSA 90x62x0,8	90	62	0,8	15066
PSA 85x78x2,5	85	78	2,5	17901	PSA 90x62x1	90	62	1	15066
PSA 86x25x1	86	25	1	5805	PSA 90x65x1,8	90	65	1,8	15795
PSA 86x30x1	86	30	1	6966	PSA 90x70x1	90	70	1	17010

\* Unless otherwise indicated, profiles are made of EN AW-6060T6 alloy

\* All dimensions are expressed in mm

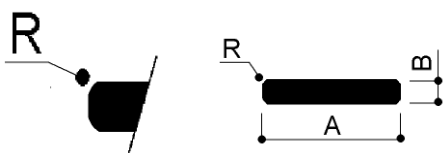

For more sizes of aluminum rounded edge plates, please visit:

[www.piatti-alluminio.it](http://www.piatti-alluminio.it)

## PLATES WITH ROUNDED EDGES

PIATTI A SPIGOLI ARROTONDATI	A	B	R	GR/MT	PIATTI A SPIGOLI ARROTONDATI	A	B	R	GR/MT
PSA 90x70x1,8	90	70	1,8	17010	PSA 100x35x1	100	35	1	9450
PSA 90x70x2	90	70	2	17000	PSA 100x35x1,5	100	35	1,5	9450
PSA 90x75x1,8	90	75	1,8	18225	PSA 100x35x1,8	100	35	1,8	9450
PSA 90x80x1	90	80	1	19437	PSA 100x35x2,5	100	35	2,5	9436
PSA 90x80x1,8	90	80	1,8	19432	PSA 100x40x1	100	40	1	10080
PSA 90x110x1	90	110	1	26727	PSA 100x40x1,5	100	40	1,5	11195
PSA 91,75x39x2,5	91,75	39	2,5	9661	PSA 100x40x1,8	100	40	1,8	10800
PSA 92x31x1	92	31	1	7700	PSA 100x45x1,8	100	45	1,8	12150
PSA 92x32x1	92	32	1	8443	PSA 100x50x1	100	50	1	13500
PSA 92x77x2,5	92	77	2,5	19127	PSA 100x50x1,5	100	50	1,5	13500
PSA 93x63x1,8	93	63	1,8	15811	PSA 100x50x1,8	100	50	1,8	13500
PSA 93,5x5x1	93,5	5	1	1264	PSA 100x50x2,5	100	50	2,5	13482
PSA 94x30x1	94	30	1	7611	PSA 100x60x1	100	60	1	16200
PSA 95x25,4x1	95	25,4	1	6512	PSA 100x60x1,8	100	60	1,8	16200
PSA 95x70x1,8	95	70	1,8	17955	PSA 100x60x3	100	60	3	16174
PSA 95x70x2,5	95	70	2,5	17955	PSA 100x63x2,5	100	63	2,5	17010
PSA 95,25x15,9x1	95,25	15,9	1	4088	PSA 100x70x1	100	70	1	18900
PSA 96x36x2,5	96	36	2,5	9331	PSA 100x70x1,8	100	70	1,8	18900
PSA 96x47x2,5	96	47	2,5	12182	PSA 100x75x1,8	100	75	1,8	20250
PSA 96x65x1,8	96	65	1,8	16840	PSA 100x75x2,5	100	75	2,5	20236
PSA 98x35x2	98	35	2	9252	PSA 100x80x1	100	80	1	21600
PSA 98x75x1	98	75	1	19845	PSA 100x80x1,8	100	80	1,8	21600
PSA 99x31,75x1	99	31,75	1	8483	PSA 100x80x2,5	100	80	2,5	21600
PSA 100x3,5	100	3,5		936	PSA 100x85x3	100	85	3	22950
PSA 100x5x0,5	100	5	0,5	1350	PSA 100x87x2	100	87	2	23490
PSA 100x5x1	100	5	1	1350	PSA 100x90x2	100	90	2	24300
PSA 100x5,5x0,5	100	5,5	0,5	1484	PSA 101,6x25,4x1	101,6	25,4	1	6968
PSA 100x5,75	100	5,75	5,75	1530	PSA 101,6x31,75x1	101,6	31,75	1	8710
PSA 100x6	100	6		1598	PSA 101,6x31,75x1,8	101,6	31,75	1,8	8710
PSA 100x6x1	100	6	1	1620	PSA 101,6x38,1x1	101,6	38,1	1	10452
PSA 100x8x0,6	100	8	0,6	2160	PSA 101,6x38,1x1,8	101,6	38,1	1,8	10452
PSA 100x8x1	100	8	1	2160	PSA 101,6x44,45x1,8	101,6	44,45	1,8	12194
PSA 100x8x1,6	100	8	1,6	2155	PSA 101,6x50,8x1	101,6	50,8	1	13935
PSA 100x9x0,5	100	9	0,5	2429	PSA 101,6x50,8x2,5	101,6	50,8	2,5	13935
PSA 100x10x0,5	100	10	0,5	2700	PSA 101,6x57,15x1,8	101,6	57,15	1,8	15677
PSA 100x10x1	100	10	1	2700	PSA 101,6x57,15x3	101,6	57,15	3	15655
PSA 100x12x0,8	100	12	0,8	3240	PSA 101,6x63,5x1	101,6	63,5	1	17419
PSA 100x12x1	100	12	1	3240	PSA 101,6x63,5x1,8	101,6	63,5	1,8	17419
PSA 100x15x0,8	100	15	0,8	4050	PSA 101,6x76,2x1	101,6	76,2	1	20903
PSA 100x15x1	100	15	1	4050	PSA 101,6x76,2x1,8	101,6	76,2	1,8	20903
PSA 100x16x0,8	100	16	0,8	4320	PSA 101,6x76,2x2,5	101,6	76,2	2,5	20903
PSA 100x20x1	100	20	1	5400	PSA 101,6x88,9x1	101,6	88,9	1	24384
PSA 100x20x3	100	20	3	5379	PSA 101,6x88,9x2	101,6	88,9	2	24387
PSA 100x25x1	100	25	1	6750	PSA 102x62x1	102	62	1	17075
PSA 100x30x1	100	30	1	8100	PSA 102x62x2,5	102	62	2,5	17075
PSA 100x31x1	100	31	1	8370	PSA 102x82x2	102	82	2	22583
PSA 100x32x1	100	32	1	8640	PSA 102x82x2,5	102	82	2,5	22583
PSA 100x35x0,8	100	35	0,8	9449	PSA 103x65x2	103	65	2	18077

\* Unless otherwise indicated, profiles are made of EN AW-6060T6 alloy

\* All dimensions are expressed in mm

Via Newton, n.12  
20016 Pero (Milano - Italy)  
Tel. +39 02 3535955 r.a. Fax. +39 02 3539929  
E-Mail: info@omar-alluminio.it

Cataloghi Online: [www.omar-alluminio.it](http://www.omar-alluminio.it)

[www.omar-alluminio.com](http://www.omar-alluminio.com)

CUSTOM ALUMINUM PROFILES / STANDARD / SPECIAL / AND FOR:  
ELECTRONICS / LED / PHOTOVOLTAIC / ROBOTIC AUTOMATION / PNEUMATICS / AUTOMOTIVE



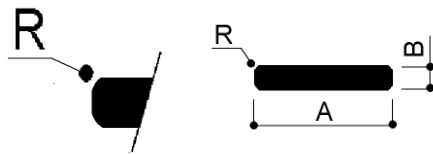

For more sizes of aluminum rounded edge plates, please visit:

[www.piatti-alluminio.it](http://www.piatti-alluminio.it)

## PLATES WITH ROUNDED EDGES

PIATTI A SPIGOLI ARROTONDATI	A	B	R	GR/MT	PIATTI A SPIGOLI ARROTONDATI	A	B	R	GR/MT
PSA 103x78x2,5	103	78	2,5	21692	PSA 112x70x1,8	112	70	1,8	21168
PSA 103x85x2	103	85	2	23635	PSA 112x72x2,5	112	72	2,5	21773
PSA 103,5x5x1	103,5	5	1	1399	PSA 114x20x1	114	20	1	6153
PSA 104x40x2	104	40	2	11223	PSA 114,3x57,15x1,8	114,3	57,15	1,8	17637
PSA 105x10x0,8	105	10	0,8	2832	PSA 114,3x63,5x2,5	114,3	63,5	2,5	19597
PSA 105x14x0,8	105	14	0,8	3966	PSA 114,3x88,9x2,5	114,3	88,9	2,5	27435
PSA 105x35x1,5	105	35	1,5	9917	PSA 115x5x0,3	115	5	0,3	1552
PSA 105x50x1	105	50	1	14175	PSA 115x8x0,6	115	8	0,6	2483
PSA 105x50x1,5	105	50	1,5	14175	PSA 115x54x1	115	54	1	16765
PSA 105x55x1,8	105	55	1,8	15593	PSA 115x65x1,8	115	65	1,8	20183
PSA 105x70x1,8	105	70	1,8	19845	PSA 115x75x1,8	115	75	1,8	23288
PSA 105x90x2	105	90	2	25515	PSA 116x65x2,5	116	65	2,5	20358
PSA 105x95x2	105	95	2	26933	PSA 117x70x1	117	70	1	22110
PSA 106x86x3	106	86	3	24613	PSA 118x93x2,5	118	93	2,5	29630
PSA 107x34x3	107	34	3	9823	PSA 120x4x1	120	4	1	1294
PSA 107,95x57,20x1	107,95	57,2	1	16669	PSA 120x5x0,2	120	5	0,2	1615
PSA 108x54x1,8	108	54	1,8	15746	PSA 120x5x0,5	120	5	0,5	1619
PSA 108x84x2	108	84	2	24494	PSA 120x6x1	120	6	1	1944
PSA 109x2,5	109	2,5		731	PSA 120x6,3	120	6,3		1272
PSA 109x3,5	109	3,5		1020	PSA 120x8x0,5	120	8	0,5	2592
PSA 109x69x2,5	109	69	2,5	20307	PSA 120x8x1	120	8	1	2592
PSA 110x2	110	2		591	PSA 120x10x0,5	120	10	0,5	3240
PSA 110x5x2,6	110	5	2,6	1593	PSA 120x10x1	120	10	1	3240
PSA 110x6x1	110	6	1	1779	PSA 120x10x1,5	120	10	1,5	3240
PSA 110x15x1	110	15	1	4452	PSA 120x12x0,8	120	12	0,8	3885
PSA 110x20x1	110	20	1	5940	PSA 120x12x1	120	12	1	3888
PSA 110x26x1,5	110	26	1,5	7722	PSA 120x15x0,9	120	15	0,9	4857
PSA 110x30x1	110	30	1	8908	PSA 120x15x1	120	15	1	4860
PSA 110x30x1,5	110	30	1,5	8910	PSA 120x20x1	120	20	1	6480
PSA 110x35x1,8	110	35	1,8	10395	PSA 120x25x1	120	25	1	8100
PSA 110x40x1,5	110	40	1,5	11880	PSA 120x30x1	120	30	1	9720
PSA 110x40x2,5	110	40	2,5	11880	PSA 120x35x1	120	35	1	11340
PSA 110x41x1,8	110	41	1,8	12177	PSA 120x35x1,5	120	35	1,5	11340
PSA 110x55x1,8	110	55	1,8	16335	PSA 120x35x1,8	120	35	1,8	11340
PSA 110x60x1,8	110	60	1,8	16335	PSA 120x40x1	120	40	1	12960
PSA 110x65x1,8	110	65	1,8	19305	PSA 120x40x1,5	120	40	1,5	12955
PSA 110x65x2,5	110	65	2,5	19305	PSA 120x40x1,8	120	40	1,8	12960
PSA 110x68x1	110	68	1	20196	PSA 120x45x1	120	45	1	14575
PSA 110x70x1,8	110	70	1,8	20790	PSA 120x45x1,5	120	45	1,5	14575
PSA 110x80x1,8	110	80	1,8	23760	PSA 120x45x1,8	120	45	1,8	14580
PSA 110x85x2,5	110	85	2,5	25245	PSA 120x50x1	120	50	1	16200
PSA 110x85x3	110	85	3	25245	PSA 120x50x1,5	120	50	1,5	16195
PSA 110x90x1	110	90	1	26730	PSA 120x50x1,8	120	50	1,8	16200
PSA 110x90x2	110	90	2	26730	PSA 120x60x1	120	60	1	19440
PSA 110x90x2,5	110	90	2,5	26730	PSA 120x60x1,8	120	60	1,8	19440
PSA 110x90x3	110	90	3	26730	PSA 120x60x2,5	120	60	2,5	19440
PSA 110x100x2,5	110	100	2,5	29687	PSA 120x70x1	120	70	1	22680
PSA 110x100x3	110	100	3	29700	PSA 120x70x1,8	120	70	1,8	22680

\* Unless otherwise indicated, profiles are made of EN AW-6060T6 alloy

\* All dimensions are expressed in mm

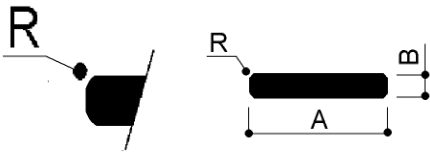

For more sizes of aluminum rounded edge plates, please visit:

[www.piatti-alluminio.it](http://www.piatti-alluminio.it)  
**PLATES WITH ROUNDED EDGES**

PIATTI A SPIGOLI ARROTONDATI	A	B	R	GR/MT	PIATTI A SPIGOLI ARROTONDATI	A	B	R	GR/MT
PSA 120x70x2	120	70	2	22680	PSA 130x55x1,8	130	55	1,8	19305
PSA 120x80x1	120	80	1	25920	PSA 130x60x1	130	60	1	21060
PSA 120x80x1,8	120	80	1,8	25920	PSA 130x60x1,8	130	60	1,8	21060
PSA 120x90x2	120	90	2	29160	PSA 130x62x1	130	62	1	21759
PSA 120x100x2	120	100	2	32400	PSA 130x70x1	130	70	1	24570
PSA 120x100x3	120	100	3	32400	PSA 130x80x2,5	130	80	2,5	28080
PSA 120,65x63,5x1	120,65	63,5	1	20685	PSA 130x90x2	130	90	2	31950
PSA 125x12x1	125	12	1	4045	PSA 130x90x3	130	90	3	31590
PSA 125x20x1	125	20	1	6470	PSA 130x100x2	130	100	2	35100
PSA 125x25x1,5	125	25	1,5	8438	PSA 131x31x1	131	31	1	10965
PSA 125x30x1,5	125	30	1,5	10125	PSA 132x102x1	132	102	1	36350
PSA 125x40x1	125	40	1	13500	PSA 133x93x1	133	93	1	33396
PSA 125x41x1,8	125	41	1,8	13838	PSA 133,5x10x0,5	133,5	10	0,5	3604
PSA 125x73x1,8	125	73	1,8	24638	PSA 134x15x0,5	134	15	0,5	5426
PSA 125x80x1,8	125	80	1,8	27000	PSA 134x24,2x1	134	24,2	1	8753
PSA 125x85x2	125	85	2	28688	PSA 135x40x1,8	135	40	1,8	14580
PSA 125x95x2	125	95	2	32063	PSA 135x50x2,5	135	50	2,5	18225
PSA 127x15,9x1	127	15,9	1	5449	PSA 135x90x2	135	90	2	32805
PSA 127x25,4x1	127	25,4	1	8710	PSA 135x104x2,5	135	104	2,5	37895
PSA 127x31,75x1,8	127	31,75	1,8	10887	PSA 136x12x1	136	12	1	4406
PSA 127x38,1x1,8	127	38,1	1,8	13064	PSA 136x85x1	136	85	1	31207
PSA 127x50,8x1	127	50,8	1	17418	PSA 140x8x1	140	8	1	3024
PSA 127x50,8x1,8	127	50,8	1,8	17419	PSA 140x10x0,5	140	10	0,5	3779
PSA 127x63,5x2,5	127	63,5	2,5	21774	PSA 140x15x1,5	140	15	1,5	5665
PSA 127x76,2x1	127	76,2	1	26128	PSA 140x20x1	140	20	1	7560
PSA 127x76,2x1,8	127	76,2	1,8	26129	PSA 140x25x1	140	25	1	9447
PSA 127x76,2x2,5	127	76,2	2,5	26129	PSA 140x30x1	140	30	1	11340
PSA 127x86x1	127	86	1	29487	PSA 140x34x1,5	140	34	1,5	12847
PSA 127x88,9x1	127	88,9	1	30821	PSA 140x40x1	140	40	1	15120
PSA 127x101,6x1	127	101,6	1	34835	PSA 140x40x1,8	140	40	1,8	15120
PSA 127x101,6x2	127	101,6	2	34839	PSA 140x50x1	140	50	1	18900
PSA 127x101,6x3	127	101,6	3	34839	PSA 140x60x1	140	60	1	22680
PSA 127x115x4	127	115	4	39434	PSA 140x60x1,8	140	60	1,8	22680
PSA 128x93x1	128	93	1	32141	PSA 140x70x1	140	70	1	26460
PSA 130x3x1	130	3	1	10530	PSA 140x70x1,8	140	70	1,8	26460
PSA 130x5x1	130	5	1	1755	PSA 140x80x1	140	80	1	30240
PSA 130x8x1	130	8	1	2808	PSA 140x80x1,8	140	80	1,8	30240
PSA 130x10x0,6	130	10	0,6	3510	PSA 140x90x3	140	90	3	34020
PSA 130x15x1	130	15	1	5265	PSA 140x100x2	140	100	2	37800
PSA 130x20x1	130	20	1	7020	PSA 140,3x40,3x1,8	140,3	40,3	1,8	15266
PSA 130x25x1	130	25	1	8775	PSA 140,4x40,3x1	140,4	40,3	1	15272
PSA 130x30x1	130	30	1	10530	PSA 141x36,6x1	141	36,6	1	13934
PSA 130x40x1	130	40	1	14040	PSA 142x5,5x0,5	142	5,5	0,5	2108
PSA 130x40x1,5	130	40	1,5	14040	PSA 143x48x1	143	48	1	18530
PSA 130x40x1,8	130	40	1,8	14040	PSA 145x45x1	145	45	1	17615
PSA 130x45x1,8	130	45	1,8	15795	PSA 145x110x2	145	110	2	43065
PSA 130x50x1,5	130	50	1,5	17550	PSA 145x130x2,5	145	130	2,5	50895
PSA 130x50x1,8	130	50	1,8	17550	PSA 146x81x1	146	81	1	31928

\* Unless otherwise indicated, profiles are made of EN AW-6060T6 alloy

\* All dimensions are expressed in mm

Via Newton, n.12  
 20016 Pero (Milano - Italy)  
 Tel. +39 02 3535955 r.a. Fax. +39 02 3539929  
 E-Mail: info@omar-alluminio.it

Cataloghi Online: [www.omar-alluminio.it](http://www.omar-alluminio.it)  
[www.omar-alluminio.com](http://www.omar-alluminio.com)  
 CUSTOM ALUMINUM PROFILES / STANDARD / SPECIAL / AND FOR:  
 ELECTRONICS / LED / PHOTOVOLTAIC / ROBOTIC AUTOMATION / PNEUMATICS / AUTOMOTIVE

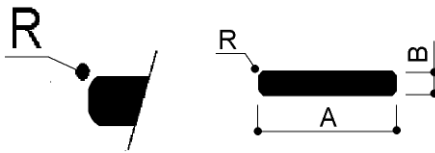

For more sizes of aluminum rounded edge plates, please visit:

[www.piatti-alluminio.it](http://www.piatti-alluminio.it)

## PLATES WITH ROUNDED EDGES

PIATTI A SPIGOLI ARROTONDATI	A	B	R	GR/MT	PIATTI A SPIGOLI ARROTONDATI	A	B	R	GR/MT
PSA 150x3x0,3	150	3	0,3	1215	PSA 152,4x31,75x1,8	152,4	31,75	1,8	13064
PSA 150x5x0,8	150	5	0,8	2024	PSA 152,4x38,1x1,8	152,4	38,1	1,8	15677
PSA 150x6x1	150	6	1	2430	PSA 152,4x50,8x1,8	152,4	50,8	1,8	20903
PSA 150x8x0,5	150	8	0,5	3240	PSA 152,4x57,15x1,8	152,4	57,15	1,8	23516
PSA 150x8x1	150	8	1	3240	PSA 152,4x63,5x1,8	152,4	63,5	1,8	26129
PSA 150x10	150	10		3990	PSA 152,4x76,2x1,8	152,4	76,2	1,8	31355
PSA 150x10x0,6	150	10	0,6	4050	PSA 152,4x76,2x2,5	152,4	76,2	2,5	31355
PSA 150x10x0,8	150	10	0,8	4049	PSA 152,4x88,9x2	152,4	88,9	2	36581
PSA 150x10x1	150	10	1	4050	PSA 152,4x101,6x2	152,4	101,6	2	41806
PSA 150x12x0,8	150	12	0,8	4859	PSA 152,4x101,6x3	152,4	101,6	3	41781
PSA 150x12x1	150	12	1	4860	PSA 152,4x127x2,5	152,4	127	2,5	52258
PSA 150x15x0,8	150	15	0,8	6074	PSA 153x128x4	153	128	4	52877
PSA 150x15x1	150	15	1	6090	PSA 155x70x1,8	155	70	1,8	29295
PSA 150x20x1	150	20	1	8100	PSA 155x80x1,8	155	80	1,8	33480
PSA 150x25x1	150	25	1	10123	PSA 155x90x2	155	90	2	37665
PSA 150x30x1	150	30	1	12050	PSA 160x5	160	5		2143
PSA 150x34x1,5	150	34	1,5	13765	PSA 160x5,5	160	5,5		2357
PSA 150x35x1,8	150	35	1,8	14175	PSA 160x10x1	160	10	1	4317
PSA 150x40x1	150	40	1	16200	PSA 160x12x1	160	12	1	5181
PSA 150x40x1,5	150	40	1,5	16200	PSA 160x15x1	160	15	1	6480
PSA 150x40x1,8	150	40	1,8	16200	PSA 160x15x1,5	160	15	1,5	6480
PSA 150x45x1,8	150	45	1,8	18225	PSA 160x20x1	160	20	1	8640
PSA 150x50x1	150	50	1	20250	PSA 160x20x1,5	160	20	1,5	8635
PSA 150x50x1,5	150	50	1,5	20250	PSA 160x25x1	160	25	1	10800
PSA 150x50x1,8	150	50	1,8	20250	PSA 160x30x1	160	30	1	12960
PSA 150x60x1	150	60	1	24300	PSA 160x35x1,8	160	35	1,8	15112
PSA 150x60x1,8	150	60	1,8	24300	PSA 160x40x1	160	40	1	17280
PSA 150x65x1,8	150	65	1,8	26325	PSA 160x40x2,5	160	40	2,5	17280
PSA 150x70x1,8	150	70	1,8	28350	PSA 160x50x1	160	50	1	21600
PSA 150x75x1,8	150	75	1,8	30375	PSA 160x50x1,8	160	50	1,8	21600
PSA 150x80x1,8	150	80	1,8	32400	PSA 160x60x1	160	60	1	25920
PSA 150x80x2,5	150	80	2,5	32400	PSA 160x60x1,8	160	60	1,8	25920
PSA 150x85x2	150	85	2	34425	PSA 160x65x1,8	160	65	1,8	28080
PSA 150x90x1	150	90	1	36450	PSA 160x70x1	160	70	1	30240
PSA 150x90x2	150	90	2	36450	PSA 160x75x1,8	160	75	1,8	32400
PSA 150x90x3	150	90	3	36450	PSA 160x80x1,8	160	80	1,8	34560
PSA 150x100x1	150	100	1	40497	PSA 160x85x2	160	85	2	36720
PSA 150x100x2	150	100	2	40500	PSA 160x90x2	160	90	2	38880
PSA 150x110x3	150	110	3	44550	PSA 160x100x2	160	100	2	43200
PSA 150x120x2	150	120	2	48600	PSA 160x120x2	160	120	2	51840
PSA 150x120x3	150	120	3	48600	PSA 160x130x2,5	160	130	2,5	56160
PSA 150x140x2,5	150	140	2,5	56700	PSA 162x60x2	162	60	2	26234
PSA 152x19x0,3	152	19	0,3	7800	PSA 162x71x1,5	162	71	1,5	31055
PSA 152x60x1,8	152	60	1,8	24624	PSA 162x133x2	162	133	2	58163
PSA 152x81x1	152	81	1	33240	PSA 164x134x4	164	134	4	59335
PSA 152x126x2	152	126	2	51710	PSA 165x5x0,8	165	5	0,8	2226
PSA 152,4x12,7x1	152,4	12,7	1	5226	PSA 165x8x1	165	8	1	3564
PSA 152,4x25,4x1	152,4	25,4	1	10452	PSA 165x55x1,8	165	55	1,8	24503

\* Unless otherwise indicated, profiles are made of EN AW-6060T6 alloy

\* All dimensions are expressed in mm

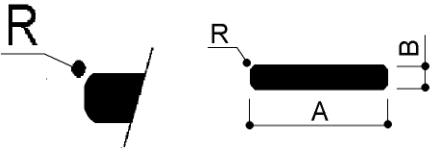

For more sizes of aluminum rounded edge plates, please visit:

[www.piatti-alluminio.it](http://www.piatti-alluminio.it)

## PLATES WITH ROUNDED EDGES

PIATTI A SPIGOLI ARROTONDATI	A	B	R	GR/MT	PIATTI A SPIGOLI ARROTONDATI	A	B	R	GR/MT
PSA 165x60x1,5	165	60	1,5	26718	PSA 180x45x1,8	180	45	1,8	21870
PSA 165x75x1,8	165	75	1,8	33413	PSA 180x50x1	180	50	1	24300
PSA 165x100x1	165	100	1	44550	PSA 180x50x1,5	180	50	1,5	24300
PSA 165x100x2	165	100	2	44550	PSA 180x60x1	180	60	1	29160
PSA 165x125x4	165	125	4	55688	PSA 180x65x1,8	180	65	1,8	31590
PSA 165x145x2,5	165	145	2,5	64598	PSA 180x70x1,8	180	70	1,8	34020
PSA 167x30x1	167	30	1	13524	PSA 180x70x2	180	70	2	34020
PSA 167x68x1	167	68	1	30659	PSA 180x75x1,8	180	75	1,8	36450
PSA 170x14x1	170	14	1	6426	PSA 180x80x1,8	180	80	1,8	38880
PSA 170x15x0,8	170	15	0,8	6885	PSA 180x90x2	180	90	2	43740
PSA 170x25x1	170	25	1	11473	PSA 180x110x3	180	110	3	53460
PSA 170x50x1	170	50	1	22950	PSA 180x130x2,5	180	130	2,5	63180
PSA 170x50x1,5	170	50	1,5	22950	PSA 182x25,4x1	182	25,4	1	12479
PSA 170x50x1,8	170	50	1,8	22950	PSA 182,88x26,5x1	182,88	26,5	1	13082
PSA 170x60x1,8	170	60	1,8	27540	PSA 183x28x1	183	28	1	13835
PSA 170x90x2	170	90	2	41310	PSA 185x16x1	185	16	1	7989
PSA 170x100x2	170	100	2	45900	PSA 185x25x1,5	185	25	1,5	12488
PSA 170x114,3x1	170	114,3	1	52464	PSA 185x65x1,8	185	65	1,8	32468
PSA 170x115x2	170	115	2	52785	PSA 185x120x3	185	120	3	59940
PSA 170x120x1	170	120	1	55077	PSA 188x86x1	188	86	1	43654
PSA 170x140x2,5	170	140	2,5	64260	PSA 188x86x1,5	188	86	1,5	43641
PSA 170x155x4	170	155	4	71145	PSA 190x15x1	190	15	1	7693
PSA 171x15x1	171	15	1	6926	PSA 190x70x1,8	190	70	1,8	35910
PSA 172x100x2	172	100	2	46440	PSA 190x72x1	190	72	1	36933
PSA 173x55x1	173	55	1	25680	PSA 190,5x12,7x1	190,5	12,7	1	6529
PSA 175x85x3	175	85	3	40163	PSA 190,5x89x1	190,5	89	1	45770
PSA 175x90x2	175	90	2	42525	PSA 192,78x26,5x1	192,78	26,5	1	13792
PSA 176x160x2,5	176	160	2,5	76032	PSA 194x115x1	194	115	1	60234
PSA 177x74x1,8	177	74	1,8	35365	PSA 194,31x9,53x1	194,31	9,53	1	5001
PSA 177,8x25,4x1	177,8	25,4	1	12194	PSA 200x5	200	5		2683
PSA 177,8x50,8x1,8	177,8	50,8	1,8	24387	PSA 200x5x0,5	200	5	0,5	2699
PSA 177,8x76,2x1,8	177,8	76,2	1,8	36581	PSA 200x8x0,5	200	8	0,5	4319
PSA 178x98x3	178	98	3	47099	PSA 200x8x1	200	8	1	4320
PSA 180x4x1	180	4	1	1944	PSA 200x10x0,6	200	10	0,6	5400
PSA 180x5x0,5	180	5	0,5	2429	PSA 200x10x1	200	10	1	5400
PSA 180x10x0,6	180	10	0,6	4860	PSA 200x12x0,5	200	12	0,5	8100
PSA 180x10x1	180	10	1	4869	PSA 200x12x0,8	200	12	0,8	6478
PSA 180x15x0,8	180	15	0,8	7290	PSA 200x12x1	200	12	1	6480
PSA 180x15x1	180	15	1	7290	PSA 200x15x0,8	200	15	0,8	8100
PSA 180x15x1,5	180	15	1,5	7285	PSA 200x15x1	200	15	1	8100
PSA 180x20x1	180	20	1	9720	PSA 200x15x3	200	15	3	8078
PSA 180x20x1,5	180	20	1,5	9715	PSA 200x20x1	200	20	1	10800
PSA 180x25x1	180	25	1	12150	PSA 200x25x1	200	25	1	13500
PSA 180x25x1,5	180	25	1,5	12145	PSA 200x25x1,5	200	25	1,5	13491
PSA 180x30x1	180	30	1	14580	PSA 200x30x0,3	200	30	0,3	16200
PSA 180x40x1	180	40	1	19440	PSA 200x30x1	200	30	1	16200
PSA 180x40x1,8	180	40	1,8	19440	PSA 200x31x1	200	31	1	16740
PSA 180x45x1,5	180	45	1,5	21870	PSA 200x35x1,5	200	35	1,5	18895

\* Unless otherwise indicated, profiles are made of EN AW-6060T6 alloy

\* All dimensions are expressed in mm

For more sizes of aluminum rounded edge plates, please visit:

[www.piatti-alluminio.it](http://www.piatti-alluminio.it)

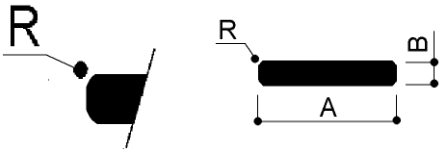

## ROUNDED EDGE PLATES

PIATTI A SPIGOLI ARROTONDATI	A	B	R	GR/MT	PIATTI A SPIGOLI ARROTONDATI	A	B	R	GR/MT
PSA 165x60x1,5	165	60	1,5	26718	PSA 180x45x1,8	180	45	1,8	21870
PSA 165x75x1,8	165	75	1,8	33413	PSA 180x50x1	180	50	1	24300
PSA 165x100x1	165	100	1	44550	PSA 180x50x1,5	180	50	1,5	24300
PSA 165x100x2	165	100	2	44550	PSA 180x60x1	180	60	1	29160
PSA 165x125x4	165	125	4	55688	PSA 180x65x1,8	180	65	1,8	31590
PSA 165x145x2,5	165	145	2,5	64598	PSA 180x70x1,8	180	70	1,8	34020
PSA 167x30x1	167	30	1	13524	PSA 180x70x2	180	70	2	34020
PSA 167x68x1	167	68	1	30659	PSA 180x75x1,8	180	75	1,8	36450
PSA 170x14x1	170	14	1	6426	PSA 180x80x1,8	180	80	1,8	38880
PSA 170x15x0,8	170	15	0,8	6885	PSA 180x90x2	180	90	2	43740
PSA 170x25x1	170	25	1	11473	PSA 180x110x3	180	110	3	53460
PSA 170x50x1	170	50	1	22950	PSA 180x130x2,5	180	130	2,5	63180
PSA 170x50x1,5	170	50	1,5	22950	PSA 182x25,4x1	182	25,4	1	12479
PSA 170x50x1,8	170	50	1,8	22950	PSA 182,88x26,5x1	182,88	26,5	1	13082
PSA 170x60x1,8	170	60	1,8	27540	PSA 183x28x1	183	28	1	13835
PSA 170x90x2	170	90	2	41310	PSA 185x16x1	185	16	1	7989
PSA 170x100x2	170	100	2	45900	PSA 185x25x1,5	185	25	1,5	12488
PSA 170x114,3x1	170	114,3	1	52464	PSA 185x65x1,8	185	65	1,8	32468
PSA 170x115x2	170	115	2	52785	PSA 185x120x3	185	120	3	59940
PSA 170x120x1	170	120	1	55077	PSA 188x86x1	188	86	1	43654
PSA 170x140x2,5	170	140	2,5	64260	PSA 188x86x1,5	188	86	1,5	43641
PSA 170x155x4	170	155	4	71145	PSA 190x15x1	190	15	1	7693
PSA 171x15x1	171	15	1	6926	PSA 190x70x1,8	190	70	1,8	35910
PSA 172x100x2	172	100	2	46440	PSA 190x72x1	190	72	1	36933
PSA 173x55x1	173	55	1	25680	PSA 190,5x12,7x1	190,5	12,7	1	6529
PSA 175x85x3	175	85	3	40163	PSA 190,5x89x1	190,5	89	1	45770
PSA 175x90x2	175	90	2	42525	PSA 192,78x26,5x1	192,78	26,5	1	13792
PSA 176x160x2,5	176	160	2,5	76032	PSA 194x115x1	194	115	1	60234
PSA 177x74x1,8	177	74	1,8	35365	PSA 194,31x9,53x1	194,31	9,53	1	5001
PSA 177,8x25,4x1	177,8	25,4	1	12194	PSA 200x5	200	5		2683
PSA 177,8x50,8x1,8	177,8	50,8	1,8	24387	PSA 200x5x0,5	200	5	0,5	2699
PSA 177,8x76,2x1,8	177,8	76,2	1,8	36581	PSA 200x8x0,5	200	8	0,5	4319
PSA 178x98x3	178	98	3	47099	PSA 200x8x1	200	8	1	4320
PSA 180x4x1	180	4	1	1944	PSA 200x10x0,6	200	10	0,6	5400
PSA 180x5x0,5	180	5	0,5	2429	PSA 200x10x1	200	10	1	5400
PSA 180x10x0,6	180	10	0,6	4860	PSA 200x12x0,5	200	12	0,5	8100
PSA 180x10x1	180	10	1	4869	PSA 200x12x0,8	200	12	0,8	6478
PSA 180x15x0,8	180	15	0,8	7290	PSA 200x12x1	200	12	1	6480
PSA 180x15x1	180	15	1	7290	PSA 200x15x0,8	200	15	0,8	8100
PSA 180x15x1,5	180	15	1,5	7285	PSA 200x15x1	200	15	1	8100
PSA 180x20x1	180	20	1	9720	PSA 200x15x3	200	15	3	8078
PSA 180x20x1,5	180	20	1,5	9715	PSA 200x20x1	200	20	1	10800
PSA 180x25x1	180	25	1	12150	PSA 200x25x1	200	25	1	13500
PSA 180x25x1,5	180	25	1,5	12145	PSA 200x25x1,5	200	25	1,5	13491
PSA 180x30x1	180	30	1	14580	PSA 200x30x0,3	200	30	0,3	16200
PSA 180x40x1	180	40	1	19440	PSA 200x30x1	200	30	1	16200
PSA 180x40x1,8	180	40	1,8	19440	PSA 200x31x1	200	31	1	16740
PSA 180x45x1,5	180	45	1,5	21870	PSA 200x35x1,5	200	35	1,5	18895

\* Unless otherwise indicated, profiles are made of EN AW-6060T6 alloy

\* All dimensions are expressed in mm



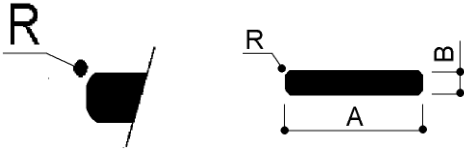

For more sizes of aluminum rounded edge plates, please visit:

[www.piatti-alluminio.it](http://www.piatti-alluminio.it)

## PLATES WITH ROUNDED EDGES

PIATTI A SPIGOLI ARROTONDATI	A	B	R	GR/MT	PIATTI A SPIGOLI ARROTONDATI	A	B	R	GR/MT
PSA 250x25x1,25	250	25	1,25	16875	PSA 310x17x1	310	17	1	14230
PSA 250x30x1	250	30	1	20250	PSA 310x19,25x0,75	310	19,25	0,75	16109
PSA 250x30x1,5	250	30	1,5	20250	PSA 310x30x1	310	30	1	25110
PSA 250x31x1	250	31	1	20925	PSA 315x27x1	315	27	1	22961
PSA 250x40x1	250	40	1	27000	PSA 320x6x0,3	320	6	0,3	5184
PSA 250x40x1,5	250	40	1,5	27000	PSA 320x15,88x1	320	15,88	1	13720
PSA 250x50x1	250	50	1	33750	PSA 325x12,7x1	325	12,7	1	11143
PSA 250x50x1,5	250	50	1,5	33750	PSA 325x60x1	325	60	1	52645
PSA 250x80x1	250	80	1	53997	PSA 330,2x27x1	330,2	27	1	24071
PSA 254x12,7x1	254	12,7	1	8708	PSA 330,2x27x2	330,2	27	2	24060
PSA 254x19,05x1	254	19,05	1	13063	PSA 330,2x31,75x1	330,2	31,75	1	28301
PSA 259x15x1	259	15	1	10490	PSA 330,2x31,75x2	330,2	31,75	2	28295
PSA 265x20x1,5	265	20	1,5	14304	PSA 333x38x1,5	333	38	1,5	34165
PSA 265x22x1	265	22	1	15738	PSA 334x38x1	334	38	1	34266
PSA 266x12,7x1	266	12,7	1	9115	PSA 336x26,5x1	336	26,5	1	24038
PSA 266,7x26,5x1	266,7	26,5	1	19081	PSA 336x33,5x1	336	33,5	1	30386
PSA 270x20x1	270	20	1	14590	PSA 340x21x1	340	21	1	19360
PSA 270x50x1	270	50	1	36442	PSA 340x57x1	340	57	1	52323
PSA 270x50x1,5	270	50	1,5	36450	PSA 342x26,5x1	342	26,5	1	24467
PSA 280x10x0,3	280	10	0,3	7560	PSA 342x50,8x1	342	50,8	1	46907
PSA 280x10x1	280	10	1	7557	PSA 346x31,5x1	346	31,5	1	29425
PSA 280x12,7x1	280	12,7	1	9599	PSA 348x15x1	348	15	1	14238
PSA 280x90x2,5	280	90	2,5	28000	PSA 355,6x15x1	355,6	15	1	14396
PSA 284x26,5x1	284	26,5	1	20318	PSA 355,6x25,4x1	355,6	25,4	1	24384
PSA 284x33,4x1	284	33,4	1	25685	PSA 355,6x26,5x1	355,6	26,5	1	25439
PSA 285x12x1	285	12	1	9234	PSA 355,6x31,75x1	355,6	31,75	1	30480
PSA 285x20x1,5	285	20	1,5	15390	PSA 355,6x31,75x1,5	355,6	31,75	1,5	30477
PSA 285,75x28,57x2	285,75	28,57	2	22031	PSA 355,6x31,75x2	355,6	31,75	2	30475
PSA 285,75x31,75x1	285,75	31,75	1	24494	PSA 361,95x26,5x1	361,95	26,5	1	259
PSA 291,59x26,5x1	291,59	26,5	1	20860	PSA 392x19x1	392	19	1	20107
PSA 298,45x38,1x1	298,45	38,1	1	30700	PSA 396,5x29x1	396,5	29	1	31040
PSA 300x8x0,6	300	8	0,6	6480	PSA 396,87x9,53	396,87	9,53		10209
PSA 300x10x1	300	10	1	8097	PSA 412,8x47,25x1	412,8	47,25	1	52658
PSA 300x12x1	300	12	1	9720	PSA 416x34x1	416	34	1	38183
PSA 300x15x0,8	300	15	0,8	12150	PSA 419x31x1	419	31	1	35065
PSA 300x15x1,5	300	15	1,5	12150	PSA 432x10x1	432	10	1	11659
PSA 300x20x1	300	20	1	16259	PSA 444,5x27,5x1	444,5	27,5	1	32999
PSA 300x30x2	300	30	2	24291	PSA 450,9x31,75x1	450,9	31,75	1	38648
PSA 304,8x26,5x1	304,8	26,5	1	21805	PSA 460x24,5x1	460	24,5	1	30429
PSA 305x16x1	305	16	1	13173	PSA 465x10x1	465	10	1	12552
PSA 310x12,7x1	310	12,7	1	10627	PSA 487,7x26,5x1	487,7	26,5	1	34700
PSA 310x15x1	310	15	1	12550					

\* Unless otherwise indicated, profiles are made of EN AW-6060T6 alloy

\* All dimensions are expressed in mm

FOLLOWS: DRAWN BARS CATALOGUE

# Commercial Profiles - Aluminium standard sections



For more dimensions of flat and square DRAWN aluminum bars, please visit the website:

[www.piatti-trafilati-alluminio.biz](http://www.piatti-trafilati-alluminio.biz)

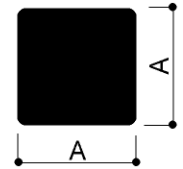
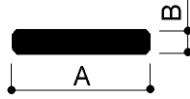

Via Newton, n. 12  
20016 Pero (Milano - Italy)  
Tel. +39 02 3535955 r.a. Fax. +39 02 3539929  
E-Mail: [info@omar-alluminio.it](mailto:info@omar-alluminio.it)

Cataloghi Online: [www.omar-alluminio.it](http://www.omar-alluminio.it)  
[www.omar-alluminio.com](http://www.omar-alluminio.com)

CUSTOM ALUMINUM PROFILES / STANDARD / SPECIAL / AND FOR:  
ELECTRONICS / LED / PHOTOVOLTAIC / ROBOTIC AUTOMATION / PNEUMATICS / AUTOMOTIVE

DRAWN FLAT BARS	DIMENSIONI A X B
PTR2116	21x16
PTR2515	25x15
PTR2520	25x20
PTR2818	28x18
PTR3015	30x15
PTR3020	30x20
PTR3025	30x25
PTR3026	30x26
PTR3116	31x16
PTR3216	32x16
PTR3218	32x18
PTR3222	32x22
PTR3416	34x16
PTR3515	35x15
PTR3520	35x20
PTR3525	35x25
PTR3618	36x18
PTR3832	38x32
PTR4015	40x15
PTR4020	40x20
PTR4022	40x22
PTR4025	40x25
PTR4030	40x30
PTR4035	40x35
PTR4227	42x27
PTR4515	45x15
PTR4525	45x25
PTR4530	45x30
PTR4535	45x35
PTR5020	50x20
PTR5025	50x25
PTR5030	50x30
PTR5035	50x35
PTR5040	50x40
PTR5230	52x30
PTR5535	55x35
PTR6020	60x20
PTR6025	60x25
PTR6030	60x30
PTR6035	60x35
PTR6040	60x40
PTR6050	60x50
PTR6535	65x35
PTR6545	65x45
PTR7030	70x30
PTR7035	70x35
PTR7040	70x40

DRAWN SQUARE BARS	DIMENSIONI A x A
BQTR15	15x15
BQTR18	18x18
BQTR20	20x20
BQTR22	22x22
BQTR24	24x24
BQTR25	25x25
BQTR26	26x26
BQTR30	30x30
BQTR32	32x32
BQTR34	34x34
BQTR35	35x35
BQTR40	40x40
BQTR42	42x42
BQTR45	45x45
BQTR46	46x46
BQTR50	50x50
BQTR52	52x52
BQTR55	55x55
BQTR60	60x60

Chemical Composition		
Si	less than/equal 0,40	
Fe	less than/equal 0,70	
Cu	5,00 ÷ 6,00	
Mn		
Mg		
Cr		
Ni		
Zn	less than/equal 0,30	
Ti		
Zr		
Pb	0,20 ÷ 0,40	
Bi	0,20 ÷ 0,60	
Al	Resto	
Physical Properties		
Tempera	T3	
Rm MPA	370	
Rp 0,2 MPA	280	
A%	15	
HBV	115	
Mechanical Properties		
Density'	KG/dm <sup>3</sup>	2,83
Form of elasticity	MPA	70000
Coefficient of thermal expansion	X 10 / °C	22,90
drivability'		
thermal a 20° C	W / mK	151
Resistance elettrica 20° C	Ω mm <sup>2</sup> / mt	0,038

**NOTE: PECULIAR TECHNICAL CHARACTERISTICS HIGH QUALITY PRODUCT**  
after careful extrusion the profile is subjected to a special wire drawing process in order to obtain high dimensional tolerance values.

\* Unless otherwise indicated, profiles are in ALLOY 2011T3 and LG. BARS MT 4.50

\* All dimensional measurements are expressed in mm



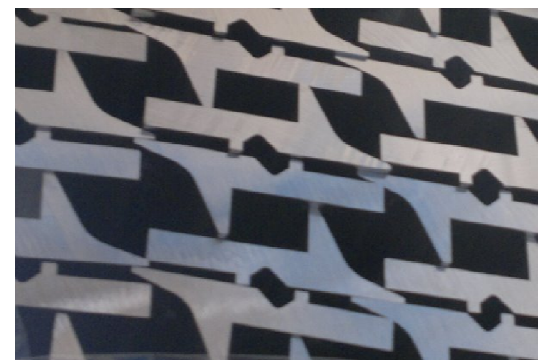
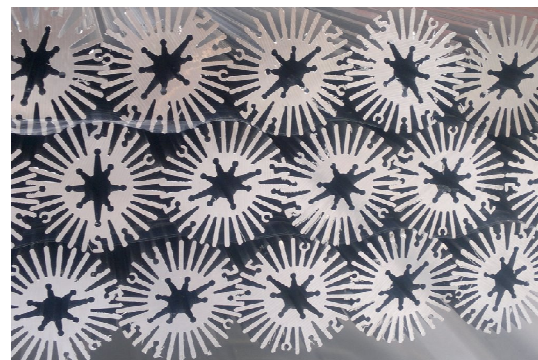
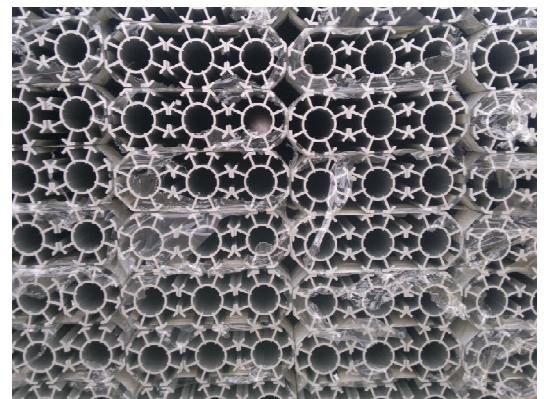
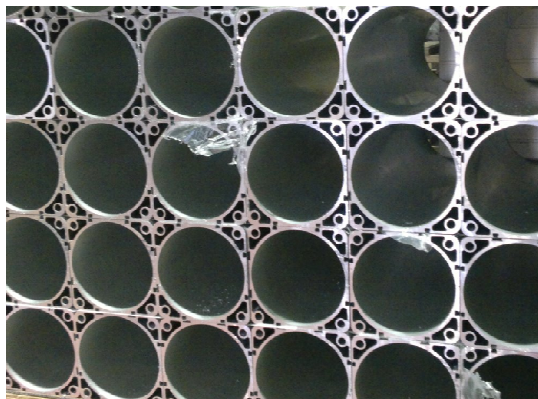
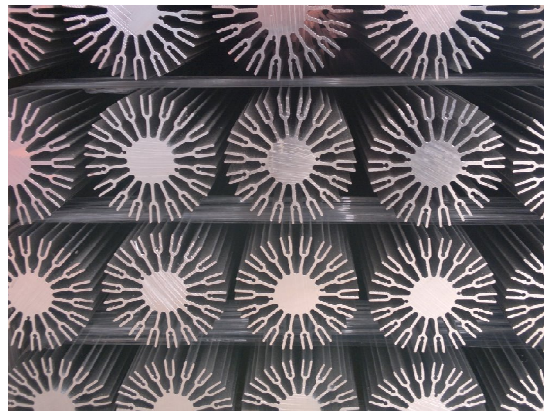
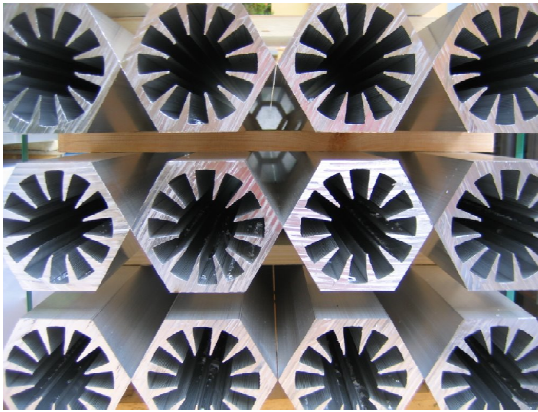

EXAMPLE PHOTO: EXTRUDED ALUMINUM PROFILES ACCORDING TO THE CUSTOMER'S DESIGN - CUSTOM -

Via Newton, n.12  
20016 Pero (Milano - Italy)  
Tel. +39 02 3535955 r.a. Fax. +39 02 3539929  
E-Mail: [info@omar-alluminio.it](mailto:info@omar-alluminio.it)

Cataloghi Online: [www.omar-alluminio.it](http://www.omar-alluminio.it)  
[www.omar-alluminio.com](http://www.omar-alluminio.com)

CUSTOM ALUMINUM PROFILES / STANDARD / SPECIAL / AND FOR:  
ELECTRONICS / LED / PHOTOVOLTAIC / ROBOTIC AUTOMATION / PNEUMATICS / AUTOMOTIVE



Pdf catalog LED heat sinks,  
profiles for housing LED strips,  
aluminum profiles for lighting technology:  
[www.led.sm](http://www.led.sm)

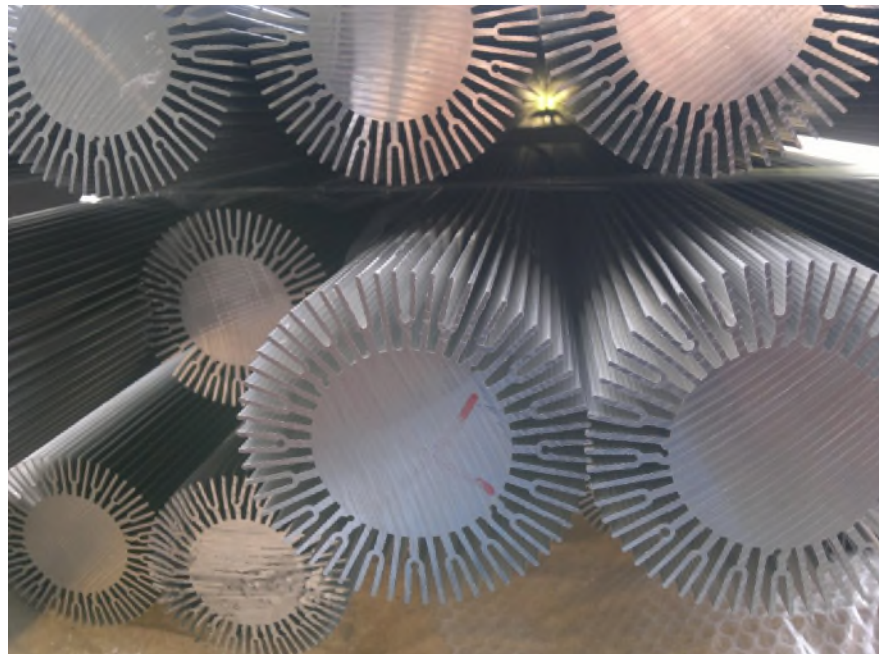

EXAMPLE PHOTO: ALUMINUM HEAT SINKS FOR LEDS (FLOWER)

FOLLOWS: CATALOGUE PROFILES RADIATED SQUARE TUBES, RADIATED RECTANGULAR TUBES

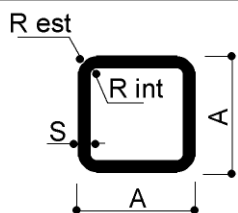

For more dimensions of square tubes with rounded edges in aluminum, please visit:

[www.tubi-alluminio.it](http://www.tubi-alluminio.it)

## RADIATED SQUARE TUBES

TUBI QUADRI RAGGIATI	A	S	R est	R int	GR/MT
TQR 7,7x7,7x1x0,5	7,7	1	0,5		72
TQR 9,5x9,5x1x1,8x0,8	9,5	1	1,8	0,8	85
TQR 10x10x1	10	1			97
TQR 10x10x1x0,6	10	1	0,6		97
TQR 10x10x1,25x0,5	10	1,25	0,5		118
TQR 12x12x1	12	1			119
TQR 12x12x1x0,5x0,5	12	1	0,5	0,5	120
TQR 12x12x1x0,5x1	12	1	0,5	1	117
TQR 12x12x1x1,5	12	1	1,5		114
TQR 12x12x1,2x2	12	1,2	2		132
TQR 12x12x1,5x0,75	12	1,5	0,75		165
TQR 12x12x1,9x0,5x1	12	1,9	0,5	1	200
TQR 12x12x2x1x0,5	12	2	1	0,5	214
TQR 13x13x1x0,5x1	13	1	0,5	1	186
TQR 13x13x1,5x1x1	13	1,5	1	1	1860
TQR 14x14x0,9x0,9	14	0,9	0,9		124
TQR 14x14x1	14	1			140
TQR 15x15x1	15	1			150
TQR 15x15x1x0,3x0,3	15	1	0,3	0,3	150
TQR 15x15x1x1	15	1	1		148
TQR 15x15x1x1,25	15	1	1,25		~150
TQR 15x15x1,3x0,3x0,5	15	1,3	0,3	0,5	190
TQR 15x15x1,5	15	1,5			216
TQR 15x15x1,5x0,5	15	1,5	0,5		218
TQR 15x15x1,5x1	15	1,5	1		216
TQR 15x15x1,5x1,5	15	1,5	1,5		210
TQR 15x15x1,5x3x0,4	15	1,5	3	0,4	197
TQR 15x15x3,375x0,5	15	3,375	0,5		397
TQR 16,9x16,9x2,3x0,5	16,9	2,3	0,5		362
TQR 18x18x1	18	1			180
TQR 18x18x1,95x2	18	1,95	2		331
TQR 20x20x1x0,3x0,3	20	1	0,3	0,3	210
TQR 20x20x1x1,25	20	1	1,25		~200
TQR 20x20x1,25x1,25x0,25	20	1,25	1,25	0,25	248
TQR 20x20x1,4x1,5	20	1,4	1,5		275
TQR 20x20x1,5x0,3x0,3	20	1,5	0,3	0,3	300
TQR 20x20x1,5x1	20	1,5	1		300
TQR 20x20x1,5x1,5x0,2	20	1,5	1,5	0,2	318
TQR 20x20x1,5x1,5x0,5	20	1,5	1,5	0,5	290
TQR 20x20x1,5x1,8x0,3	20	1,5	1,8	0,3	~300
TQR 20x20x1,5x2	20	1,5	2		292
TQR 20x20x1,8x3	20	1,8	3		336
TQR 20x20x1,8x3x0,2	20	1,8	3	0,2	333
TQR 20x20x2x0,5x0,5	20	2	0,5	0,5	389
TQR 20x20x2x1,5	20	2	1,5		384
TQR 20x20x2x2	20	2	2		380

\* Unless otherwise indicated, profiles are made of EN AW-6060T6 alloy

\* All dimensions are expressed in mm

Via Newton, n.12

20016 Pero (Milano - Italy)

Tel. +39 02 3535955 r.a. Fax. +39 02 3539929

E-Mail: info@omar-alluminio.it

Cataloghi Online: [www.omar-alluminio.it](http://www.omar-alluminio.it)

[www.omar-alluminio.com](http://www.omar-alluminio.com)

CUSTOM ALUMINUM PROFILES / STANDARD / SPECIAL / AND FOR:

ELECTRONICS / LED / PHOTOVOLTAIC / ROBOTIC AUTOMATION / PNEUMATICS / AUTOMOTIVE

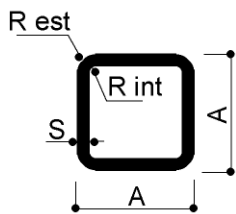

For more dimensions of square tubes with rounded edges in aluminum, please visit:

[www.tubi-alluminio.it](http://www.tubi-alluminio.it)

## RADIATED SQUARE TUBES

TUBI QUADRI RAGGIATI	A	S	R est	R int	GR/MT
TQR 20x20x2x3x1	20	2	3	1	370
TQR 20x20x2x4	20	2	4		361
TQR 20x20x2,5x2,5	20	2,5	2,5		458
TQR 22x22x1	22	1			224
TQR 22x22x1,5x2x0,3	22	1,5	2	0,3	326
TQR 23,5x23,5x1,5x1x0,4	23,5	1,5	1	0,4	353
TQR 24x24x1,25x1,75	24	1,25	1,75		307
TQR 24x24x2x0,5x2,5	24	2	0,5	2,5	460
TQR 24x24x2x3	24	2	3		457
TQR 25x25x1,2x1x0,4	25	1,2	1	0,4	307
TQR 25x25x1,2x1,5	25	1,2	1,5		303
TQR 25x25x1,4x0,3x0,3	25	1,4	0,3	0,3	360
TQR 25x25x1,4x2	25	1,4	2		~350
TQR 25x25x1,5x0,25	25	1,5	0,25		382
TQR 25x25x1,5x2	25	1,5	2		372
TQR 25x25x1,5x3x0,2	25	1,5	3	0,2	365
TQR 25x25x1,5x3,5x5	25	1,5	3,5	5	350
TQR 25x25x2x0,5x0,5	25	2	0,5	0,5	497
TQR 25x25x2x0,5x2,5	25	2	0,5	2,5	480
TQR 25x25x2x2x0,2	25	2	2	0,2	496
TQR 25x25x2	25	2			490
TQR 25x25x2x2	25	2	2		488
TQR 25x25x2x2x1	25	2	2	1	488
TQR 25x25x2x2,5	25	2	2,5		497
TQR 25x25x2x3	25	2	3		478
TQR 25x25x2x3x1,5	25	2	3	1,5	480
TQR 25x25x2x4x1,5	25	2	4	1,5	531
TQR 25x25x2,5x0,2x0,5	25	2,5	0,2	0,5	610
TQR 25x25x2,5x2	25	2,5	2		587
TQR 25x25x3x0,5	25	3	0,5		712
TQR 25x25x3x2	25	3	2		705
TQR 25,5x25,5x1,5x2	25,5	1,5	2		380
TQR 30x30x1,4	30	1,4			410
TQR 30x30x1,5	30	1,5			446
TQR 30x30x1,5x0,3x0,3	30	1,5	0,3	0,3	460
TQR 30x30x1,5x1,5	30	1,5	1,5	0,2	456
TQR 30x30x1,5x1,8x0,2	30	1,5	1,5	20	453
TQR 30x30x1,5x2x0,5	30	1,5	2	0,5	452
TQR 30x30x1,5x3	30	1,5	3		446
TQR 30x30x1,5x4	30	1,5	4		439
TQR 30x30x1,5x5	30	1,5	5		432
TQR 30x30x1,7x4,5x2,8	30	1,7	4,5	2,8	490
TQR 30x30x2	30	2	1		605
TQR 30x30x2x0,5x0,5	30	2	0,5	0,5	600
TQR 30x30x2x1	30	2	1		604
TQR 30x30x2x1,5	30	2	1,5		600

\* Unless otherwise indicated, profiles are made of EN AW-6060T6 alloy

\* All dimensions are expressed in mm

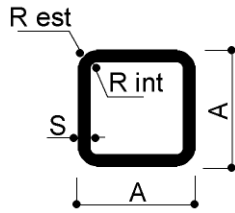

For more dimensions of square tubes with rounded edges in aluminum, please visit:

[www.tubi-alluminio.it](http://www.tubi-alluminio.it)

## RADIATED SQUARE TUBES

TUBI QUADRI RAGGIATI	A	S	R est	R int	GR/MT
TQR 30x30x2x1,8	30	2	1,8		378
TQR 30x30x2x2	30	2	2		595
TQR 30x30x2x3	30	2	3		595
TQR 30x30x2x3x2	30	2	3	2	591
TQR 30x30x2x5x2	30	2	5	2	547
TQR 30x30x2,5x0,5	30	2,5	0,5		742
TQR 30x30x2,5x2,5x5	30	2,5	2,5	5	700
TQR 30x30x3x0,5x0,5	30	3	0,5	0,5	875
TQR 30x30x3x2x2	30	3	2	2	870
TQR 30x30x3x3	30	3	3		854
TQR 30x30x3x3x1	30	3	3	1	856
TQR 30x30x4x5,5	30	4	5,5		1058
TQR 30,5x30,5x2,5x2x0,2	30,5	2,5	2	0,2	746
TQR 32x32x2x3x3	32	2	3	3	648
TQR 32x32x2x3,5	32	2	3,5		625
TQR 32,3x32,3x2x3	32,3	2	3		636
TQR 35x35x1,5x1x0,2	35	1,5	1	0,2	540
TQR 35x35x2x0,5x0,5	35	2	0,5	0,5	734
TQR 35x35x2x1,5	35	2	1,5		710
TQR 35x35x2x2x2	35	2	2	2	710
TQR 35x35x2x3x1	35	2	3	1	713
TQR 35x35x2x5x2	35	2	5	2	713
TQR 35x35x2,3x1,4	35	2,3	1,4		808
TQR 35x35x2,3x1,5	35	2,3	1,5		807
TQR 35x35x2,5x2,6	35	2,5	2,6		861
TQR 35x35x3x5	35	3	5		988
TQR 35x35x5x2x0,2	35	5	2	0,2	1630
TQR 37x37x3x5x1,5	37	3	5	1,5	1047
TQR 37,2x37,2x3x5	37,2	3	5		1059
TQR 38x38x1,2x4	38	1,2	4		457
TQR 38x38x1,5x5	38	1,5	5		562
TQR 38x38x2x1x0,2	38	2	1	0,2	775
TQR 38x38x2,5x2	38	2,5	2		949
TQR 38x38x3x2x0,5	38	3	2	0,5	1125
TQR 38x38x3,5x2,5	38	3,5	2,5		1290
TQR 40x40x1,5x0,3x0,3	40	1,5	0,3	0,3	500
TQR 40x40x1,5x1	40	1,5	1		621
TQR 40x40x2x0,3x0,2	40	2	0,3	0,2	820
TQR 40x40x2x0,5x0,5	40	2	0,5	0,5	842
TQR 40x40x2x1	40	2	1		821
TQR 40x40x2x1,25	40	2	1,25		818
TQR 40x40x2x2	40	2	2		825
TQR 40x40x2x3	40	2	3		821
TQR 40x40x2x3x3	40	2	3	3	821
TQR 40x40x2x3,5	40	2	3,5		794
TQR 40x40x2x4x2	40	2	4	2	793

\* Unless otherwise indicated, profiles are made of EN AW-6060T6 alloy

\* All dimensions are expressed in mm

Via Newton, n.12

20016 Pero (Milano - Italy)

Tel. +39 02 3535955 r.a. Fax. +39 02 3539929

E-Mail: [info@omar-alluminio.it](mailto:info@omar-alluminio.it)

Cataloghi Online: [www.omar-alluminio.it](http://www.omar-alluminio.it)

[www.omar-alluminio.com](http://www.omar-alluminio.com)

CUSTOM ALUMINUM PROFILES / STANDARD / SPECIAL / AND FOR:

ELECTRONICS / LED / PHOTOVOLTAIC / ROBOTIC AUTOMATION / PNEUMATICS / AUTOMOTIVE

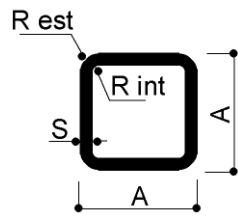

For more dimensions of square tubes with rounded edges in aluminum, please visit:

[www.tubi-alluminio.it](http://www.tubi-alluminio.it)

## RADIATED SQUARE TUBES

TUBI QUADRI RAGGIATI	A	S	R est	R int	GR/MT
TQR 40x40x2x5	40	2	5		784
TQR 40x40x2,5x0,5x0,5	40	2,5	0,5	0,5	1050
TQR 40x40x2,5x2	40	2,5	2		1004
TQR 40x40x2,5x3,5	40	2,5	3,5		986
TQR 40x40x2,5x4	40	2,5	4		980
TQR 40x40x2,5x2,5x5	40	2,5	2,5	5	970
TQR 40x40x3x0,5x0,5	40	3	0,5	0,5	1200
TQR 40x40x3x1	40	3	1		1196
TQR 40x40x3x2x0,2	40	3	2	0,2	1200
TQR 40x40x3x2x0,5	40	3	2	0,5	1189
TQR 40x40x3x4	40	3	4		1164
TQR 40x40x3,5x2	40	3,5	2		1370
TQR 40x40x4x0,3x0,5	40	4	0,3	0,5	1550
TQR 40x40x4x0,5	40	4	0,5		1555
TQR 40x40x4x0,6	40	4	0,6		1555
TQR 40x40x4x4	40	4	4		1518
TQR 40x40x4x6x2	40	4	6	2	1481
TQR 42x42x2,5x0,3x2,5	42	2,5	0,3	2,5	1050
TQR 44,5x44,5x3x8x5	44,5	3	8	5	1254
TQR 45x45x2x0,3x0,3	45	2	0,3	0,3	930
TQR 45x45x2x1,25	45	2	1,25		926
TQR 45x45x2,3x5,3x3	45	2,3	5,3	3	~1100
TQR 45x45x2,5x1x3,5	45	2,5	1	3,5	1030
TQR 45x45x3x3x0,2	45	3	3	0,2	1339
TQR 45x45x3,3x10	45	3,3	10		~1350
TQR 49x49x2x1	49	2	1		1014
TQR 50x50x2x1	50	2	1		1035
TQR 50x50x2x1,25	50	2	1,25		1034
TQR 50x50x2x2	50	2	2		1030
TQR 50x50x2x4	50	2	4		1008
TQR 50x50x2,35x1	50	2,35	1		1207
TQR 50x50x2,5x0,3x0,3	50	2,5	0,3	0,3	1280
TQR 50x50x2,5x2	50	2,5	2		1275
TQR 50x50x2,5x2x0,2	50	2,5	2	0,2	1273
TQR 50x50x2,5x2,5x0,2	50	2,5	2,5	0,2	1300
TQR 50x50x2,5x3x1	50	2,5	3	1	1263
TQR 50x50x2,5x4	50	2,5	4		1251
TQR 50x50x3x0,25	50	3	0,25		1528
TQR 50x50x3x0,5x0,5	50	3	0,5	0,5	1571
TQR 50x50x3x2	50	3	2		1514
TQR 50x50x3x2x0,3	50	3	2	0,3	1520
TQR 50x50x3x3	50	3	3		1502
TQR 50x50x3x4x1	50	3	4	1	1485
TQR 50x50x3x4x2	50	3	4	2	1523
TQR 50x50x3x5x2	50	3	5	2	1460
TQR 50x50x3,9x0,5	50	3,9	0,5		1942

\* Unless otherwise indicated, profiles are made of EN AW-6060T6 alloy

\* All dimensions are expressed in mm



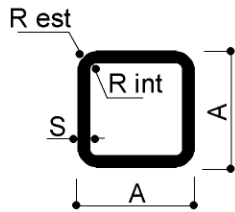

For more dimensions of square tubes with rounded edges in aluminum, please visit:

[www.tubi-alluminio.it](http://www.tubi-alluminio.it)

## RADIATED SQUARE TUBES

TUBI QUADRI RAGGIATI	A	S	R est	R int	GR/MT
TQR 50x50x4x0,5x0,5	50	4	0,5	0,5	1987
TQR 50x50x4x3	50	4	3		1966
TQR 50x50x4x4x2	50	4	4	2	1959
TQR 50x50x4x5	50	4	5		1929
TQR 50x50x5	50	5			2430
TQR 50x50x5x0,3x0,2	50	5	0,3	0,2	2430
TQR 50x50x5x2,5x0,2	50	5	2,5	0,2	2430
TQR 50x50x8x2,5	50	8	2,5		3614
TQR 50,3x50,3x2,39x3	50,3	2,39	3		1218
TQR 55x55x1,9x1,3	55	1,9	1,3		1085
TQR 59,5x59,5x1,5x4	59,5	1,5	4		1040
TQR 60x60x1,4x3,6	60	1,4	3,6		859
TQR 60x60x2x0,3x0,2	60	2	0,3	0,2	1250
TQR 60x60x2,5	60	2,5			1531
TQR 60x60x2,5x3	60	2,5	3		1532
TQR 60x60x3x0,5	60	3	0,5		1847
TQR 60x60x3x3	60	3	3		~1800
TQR 60x60x3x6	60	3	6		1784
TQR 60x60x3,5x1x3,5	60	3,5	1	3,5	2110
TQR 60x60x4x3	60	4	3		2401
TQR 60x60x8x1	60	8	1		4509
TQR 60,2x60,2x1,6x6,1	60,2	1,6	6,1		974
TQR 65x65x2x2	65	2	2		1352
TQR 70x70x2x0,3x0,3	70	2	0,3	0,3	1470
TQR 70x70x2x1x0,5	70	2	1	0,5	1466
TQR 70x70x3x1	70	3	1		2178
TQR 70x70x4x3	70	4	3		2862
TQR 70x70x4x6x2	70	4	6	2	2777
TQR 75x75x3x2,5x1,5	75	3	2,5	1,5	2330
TQR 75x75x3x3	75	3	3		2314
TQR 78,6x78,6x1,5x6	78,6	1,5	6		1335
TQR 80x80x2x0,3x0,3	80	2	0,3	0,3	1680
TQR 80x80x2x1	80	2	1		1690
TQR 80x80x2x2	80	2	2		1604
TQR 80x80x2x2,5	80	2	2,5		1670
TQR 80x80x2x3x2	80	2	3	2	1673
TQR 80x80x2x8	80	2	8		1601
TQR 80x80x2x12	80	2	12		1582
TQR 80x80x2,5x5	80	2,5	5		2049
TQR 80x80x3	80	3			2446
TQR 80x80x3x1	80	3	1		2504
TQR 80x80x3x5	80	3	5		1887
TQR 80x80x3x7x4	80	3	7	4	2418
TQR 80x80x4x0,25	80	4	0,25		3295
TQR 80x80x4x0,3	80	4	0,3		3283
TQR 80x80x4x6	80	4	6		3211

\* Unless otherwise indicated, profiles are made of EN AW-6060T6 alloy

\* All dimensions are expressed in mm

Via Newton, n.12  
20016 Pero (Milano - Italy)  
Tel. +39 02 3535955 r.a. Fax. +39 02 3539929  
E-Mail: info@omar-alluminio.it

Cataloghi Online: [www.omar-alluminio.it](http://www.omar-alluminio.it)  
[www.omar-alluminio.com](http://www.omar-alluminio.com)

CUSTOM ALUMINIUM PROFILES / STANDARD / SPECIAL / AND FOR:  
ELECTRONICS / LED / PHOTOVOLTAIC / ROBOTIC AUTOMATION / PNEUMATICS / AUTOMOTIVE

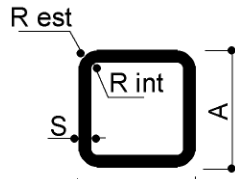

For more dimensions of square tubes with rounded edges in aluminum, please visit:

[www.tubi-alluminio.it](http://www.tubi-alluminio.it)

## RADIATED SQUARE TUBES

TUBI QUADRI RAGGIATI	A	S	R est	R int	GR/MT
TQR 80x80x6x6	80	6	6		4972
TQR 80x80x8x5	80	8	5		6172
TQR 88,5x88,5x5x1,5	88,5	5	1,5		4493
TQR 90x90x4x1x0,5	90	4	1	0,5	3717
TQR 91x91x4x3	91	4	3		~3800
TQR 100x100x2,2x8x5,8	100	2,2	8	5,8	2253
TQR 100x100x3x2	100	3	2		~3100
TQR 100x100x3x4	100	3	4		3110
TQR 100x100x3x10	100	3	10		3025
TQR 100x100x3,8x5,8	100	3,8	5,8		3880
TQR 100x100x4x0,3	100	4	0,3		4147
TQR 100x100x4x0,4x0,4	100	4	0,4	0,4	4150
TQR 100x100x4x0,9	100	4	0,9		4145
TQR 100x100x4x3x5	100	4	3	5	40200
TQR 100x100x4x7	100	4	7		4054
TQR 100x100x4,3x6	100	4,3	6		4369
TQR 100x100x5x10	100	5	10		4956
TQR 100x100x6x8	100	6	8		5952
TQR 100x100x7x10	100	7	10		6820
TQR 105x105x2x1x0,5	105	2	1	0,5	2222
TQR 105x105x10x10	105	10	10		10086
TQR 110x110x2x1	110	2	1		2330
TQR 112x112x3x5	112	3	5		3483
TQR 120x120x2,5x3x0,2	120	2,5	3	0,2	3151
TQR 120x120x3x3x0,4	120	3	3	0,4	3769
TQR 120x120x4x1x0,5	120	4	1	0,5	5011
TQR 120x120x4x3	120	4	3		5000
TQR 125x125x6x1	125	6	1		7711
TQR 130x130x2x25	130	2	25		2844
TQR 130x130x5x0,4x0,4	130	5	0,4	0,4	6750
TQR 134x134x7x4	134	7	4		9566
TQR 140x140x4x1	140	4	1		5875
TQR 140x140x3x26	140	3	26		4098
TQR 140x140x10x14	140	10	14		13625
TQR 150x150x4x0,8x0,8	150	4	0,8	0,8	6310
TQR 150x150x4	150	4			6158
TQR 150x150x6x1	150	6	1		9331
TQR 150x150x10x2	150	10	2		15113
TQR 165x165x22,5x2x2	165	22,5	2	2	34628
TQR 170x170x3x2x0,5	170	3	2	0,5	5401
TQR 182x182x4x10	182	4	10		7541
TQR 200x200x4x10	200	4	10		8319
TQR 200x200x5x1	200	5	1		10500
TQR 200x200x6x6x3	200	6	6	3	12509
TQR 200x200x10x0,5	200	10	0,5		20520
TQR 220x220x6x6	220	6	6		13805

\* Unless otherwise indicated, profiles are made of EN AW-6060T6 alloy

\* All dimensions are expressed in mm

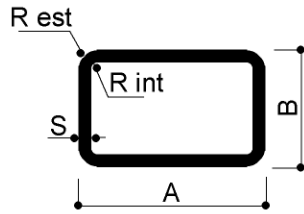

For more dimensions of rectangular tubes with rounded edges in aluminum, please visit:

[www.tubi-alluminio.it](http://www.tubi-alluminio.it)

## RADIATED RECTANGULAR TUBES

TUBI RETTANGOLARI RAGGIATI	A	B	S	R est	R int	GR/MT
TRR 9x7,8x1x1	9	7,8	1	1		78
TRR 10x8x1,35x2,5x1	10	8	1,35	2,5	1	100
TRR 12x8x1x0,5x1	12	8	1	0,5	1	100
TRR 12x10x1x0,3x0,3	12	10	1	0,3	0,3	110
TRR 12x10x1,2	12	10	1,2			125
TRR 12,5x10x0,95x1,25x0,15	12,5	10	0,95	1,25	0,15	99
TRR 15x10x1,2x0,3x0,3	15	10	1,2	0,3	0,3	150
TRR 15x12,7x2x4	15	12,7	2	4		382
TRR 16x10x1,5x2	16	10	1,5	2		177
TRR 18x12x1x0,3x0,3	18	12	1	0,3	0,3	150
TRR 18x12x1,5x2	18	12	1,5	2		209
TRR 19x14x1x1	19	14	1	1		164
TRR 20x7x1x0,5	20	7	1	0,5		134
TRR 20x7x1x1	20	7	1	1		135
TRR 20x10x1x0,3x0,3	20	10	1	0,3	0,3	150
TRR 20x10x1x2x1	20	10	1	2	1	151
TRR 20x10x1,2x0,5x0,3	20	10	1,2	0,5	0,3	178
TRR 20x12x1,5x0,5	20	12	1,5	0,5		236
TRR 20x10x1,5x0,3x0,3	20	10	1,5	0,3	0,3	220
TRR 20x10x1,5x0,5x2	20	10	1,5	0,5	2	215
TRR 20x10x2x0,3x0,3	20	10	2	0,3	0,3	280
TRR 20x13x1x0,3x0,3	20	13	1	0,3	0,3	170
TRR 20x13x1,1x0,3x1	20	13	1,1	0,3	1	180
TRR 20x13x1,2x1x1	20	13	1,2	1	1	190
TRR 20x13x1,5x1x1	20	13	1,5	1	1	243
TRR 20x14x1,5x2	20	14	1,5	2		241
TRR 20x15x1,2	20	15	1,2			211
TRR 20x15x1,2x2	20	15	1,2	2		241
TRR 20x15x1,5x2	20	15	1,5	2		250
TRR 20x15x1,5x2x1	20	15	1,5	2	1	291
TRR 20x15x1,5x2x1,3	20	15	1,5	2	1,3	246
TRR 20x15x1,5x3	20	15	1,5	3		250
TRR 20x15x2x3	20	15	2	3		316
TRR 20x15x2x3x3	20	15	2	3	3	334
TRR 21,3x12x1,5x1,5x1,5	21,3	12	1,5	1,5	1,5	254
TRR 22x12x1x2,2x1,2	22	12	1	2,2	1,2	162
TRR 22x16x2,5x0,2x0,2	22	16	2,5	0,2	0,2	445
TRR 23x13x1x0,5x0,3	23	13	1	0,5	0,3	180
TRR 23,2x10,2x1x2	23,2	10,2	1	2		163
TRR 23,5x13,5x1x2x1	23,5	13,5	1	2	1	189
TRR 24x9x1,5x1	24	9	1,5	1		241
TRR 24,2x19,3x1,35x2,5x0,5	24,2	19,3	1,35	2,5	0,5	284
TRR 24,5x14,5x1,5x0,25	24,5	14,5	1,5	0,25		301
TRR 25x10x1,5x2x0,5	25	10	1,5	2	0,5	250
TRR 25x12x1x0,5	25	12	1	0,5		188
TRR 25x12x1x1	25	12	1	1		189
TRR 25x15x1,3x1,5x0,5	25	15	1,3	1,5	0,5	260
TRR 25x15x1,5x0,3x0,3	25	15	1,5	0,3	0,3	300

\* Se non diversamente indicato i profili sono in lega EN AW-6060T6  
 \* Tutte le quote dimensionali sono espresse in mm  
 www.omar-alluminio.com

Via Newton, n.12  
 20016 Pero (Milano - Italy)  
 Tel. +39 02 3535955 r.a. Fax. +39 02 3539929  
 E-Mail: info@omar-alluminio.it



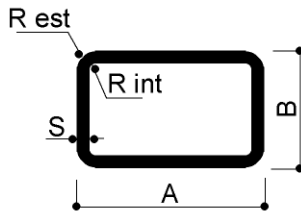

For more dimensions of rectangular tubes with rounded edges in aluminum, please visit:

[www.tubi-alluminio.it](http://www.tubi-alluminio.it)

## RADIATED RECTANGULAR TUBES

TUBI RETTANGOLARI RAGGIATI	A	B	S	R est	R int	GR/MT
TRR 25x15x1,5x0,5x0,3	25	15	1,5	0,5	0,3	297
TRR 25x15x1,5x0,8	25	15	1,5	0,8		300
TRR 25x15x1,5x1	25	15	1,5	1		297
TRR 25x15x1,5x1,5x1	25	15	1,5	1,5	1	297
TRR 25x15x1,5x3	25	15	1,5	3		284
TRR 25x15x1,8x2	25	15	1,8	2		346
TRR 25x15x2x0,3x0,3	25	15	2	0,3	0,3	480
TRR 25x15x2x0,5	25	15	2	0,5		391
TRR 25x15x2x3	25	15	2	3		370
TRR 25x16,5x1,10x2x1	25	16,5	1,1	2	1	226
TRR 25x23,5x1,2x1,8x0,6	25	23,5	1,2	1,8	0,6	292
TRR 25,4x21,4x1,2x3,2	25,4	21,4	1,2	3,2		289
TRR 26x14x1,5x3	26	14	1,5	3		285
TRR 26,5x14,5x1,5x2x0,5	26,5	14,5	1,5	2	0,5	300
TRR 27x15x1,5x1	27	15	1,5	1		313
TRR 27,5x13,2x1,2x1,5	27,5	13,2	1,2	1,5		243
TRR 27,5x17,5x1,5x2,5x4	27,5	17,5	1,5	2,5	4	320
TRR 28x15x2,8x5	28	15	2,8	5		522
TRR 28x23x2x3	28	23	2	3		489
TRR 28,5x13,5x2	28,5	13,5	2			207
TRR 30x10x1	30	10	1			205
TRR 30x10x1,2x2x0,8	30	10	1,2	2	0,8	236
TRR 30x10x1,5	30	10	1,5			300
TRR 30x10x1,5x1	30	10	1,5	1		300
TRR 30x10x2x0,25x0,25	30	10	2	0,25	0,25	390
TRR 30x10x2x0,5	30	10	2	0,5		391
TRR 30x12,5x1,5x2	30	12,5	1,5	2		311
TRR 30x15x1,3x0,5x1,5	30	15	1,3	0,5	1,5	290
TRR 30x15x1,5x0,5x1,5	30	15	1,5	0,5	1,5	360
TRR 30x15x1,5x0,5	30	15	1,5	0,5		340
TRR 30x15x1,5x1,5	30	15	1,5	1,5		335
TRR 30x15x1,5x2	30	15	1,5	2		332
TRR 30x15x1,5x2x0,5	30	15	1,5	2	0,5	331
TRR 30x15x1,5x3x1,5	30	15	1,5	3	1,5	324
TRR 30x15x1,5x7,5	30	15	1,5	7,5		293
TRR 30x15x2x0,5	30	15	2	0,5		447
TRR 30x15x2x2	30	15	2	2		435
TRR 30x15x2x2,5	30	15	2	2,5		435
TRR 30x15x2x3x1	30	15	2	3	1	425
TRR 30x18x1x0,3x0,3	30	18	1	0,3	0,3	250
TRR 30x18x1,1x2x0,9	30	18	1,1	2	0,9	264
TRR 30x18x1,2x2	30	18	1,2	2		283
TRR 30x18x1,2x2x0,5	30	18	1,2	2	0,5	287
TRR 30x18x1,2x2x0,8	30	18	1,2	2	0,8	288
TRR 30x18x1,2x2,2	30	18	1,2	2,2		287
TRR 30x18x1,2x3x1,8	30	18	1,2	3	1,8	280
TRR 30x18x1,5x2	30	18	1,5	2		355
TRR 30x18x1,5x3x0,2	30	18	1,5	3	0,2	365

\* Unless otherwise indicated, profiles are made of EN AW-6060T6 alloy

\* All dimensions are expressed in mm

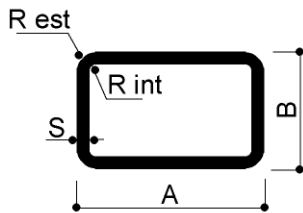

For more dimensions of rectangular tubes with rounded edges in aluminum, please visit:

[www.tubi-alluminio.it](http://www.tubi-alluminio.it)

## RADIATED RECTANGULAR TUBES

TUBI RETTANGOLARI RAGGIATI	A	B	S	R est	R int	GR/MT
TRR 30x18x1,5x3x1,5	30	18	1,5	3	1,5	348
TRR 30x18x1,5x3,5x2	30	18	1,5	3,5	2	345
TRR 30x18x1,5x4	30	18	1,5	4		341
TRR 30x18x1,5x9	30	18	1,5	9		307
TRR 30x18x1,6x3,5	30	18	1,6	3,5		367
TRR 30x18x1,6x4,5x2,9	30	18	1,6	4,5	2,9	359
TRR 30x18x2x1x3	30	18	2	1	3	460
TRR 30x18x2x9	30	18	2	9		401
TRR 30x20x1x2,2x1,2	30	20	1	2,2	1,2	248
TRR 30x20x1x2,5x3,5	30	20	1	2,5	3,5	250
TRR 30x20x1,2x3x1,8	30	20	1,2	3	1,8	308
TRR 30x20x1,4x2x2	30	20	1,4	2	2	356
TRR 30x20x1,5x0,2x0,3	30	20	1,5	0,2	0,3	380
TRR 30x20x1,5x1,5	30	20	1,5	1,5		375
TRR 30x20x1,5x2	30	20	1,5	2		371
TRR 30x20x1,5x2x0,5	30	20	1,5	2	0,5	380
TRR 30x20x1,5x2x2	30	20	1,5	2	2	373
TRR 30x20x1,5x3,5x2	30	20	1,5	3,5	2	362
TRR 30x20x1,5x5	30	20	1,5	5		355
TRR 30x20x1,5x5x3,5	30	20	1,5	5	3,5	351
TRR 30x20x2x0,4	30	20	2	0,4		497
TRR 30x20x2x0,5x0,2	30	20	2	0,5	0,2	496
TRR 30x20x2x0,5x0,5	30	20	2	0,5	0,5	500
TRR 30x20x2x1,5	30	20	2	1,5		492
TRR 30x20x2x2	30	20	2	2		488
TRR 30x20x2x3	30	20	2	3		478
TRR 30x20x2x5x2	30	20	2	5	2	497
TRR 30x20x2x10	30	20	2	10		413
TRR 30x20x3x0,5x0,5	30	20	3	0,5	0,5	710
TRR 30x24x1,5x2x2	30	24	1,5	2	2	413
TRR 30x25x1,4x6x5	30	25	1,4	6	5	369
TRR 30,5x20,5x1x2x1	30,5	20,5	1	2	1	265
TRR 31x16x1,5x3x1,5	31	16	1,5	3	1,5	340
TRR 31x20x3x2x2	31	20	3	2	2	730
TRR 32x12x2,5x0,5x0,3	32	12	2,5	0,5	0,3	523
TRR 32x18x1,5	32	18	1,5			343
TRR 33x18x1,4x2x0,6	33	18	1,4	2	0,6	364
TRR 33x20x1,5x2x3	33	20	1,5	2	3	390
TRR 33,2x20x1,2x3x1,8	33,2	20	1,2	3	1,8	318
TRR 34x15x1,6x2	34	15	1,6	2		386
TRR 34x24x1x2x1	34	24	1	2	1	303
TRR 34,7x15x1,4x1,2x1	34,7	15	1,4	1,2	1	355
TRR 35x10x1,5x1,5	35	10	1,5	1,5		335
TRR 35x15x1,5x1	35	15	1,5	1		378
TRR 35x15x1,5x3x1,5	35	15	1,5	3	1,5	356
TRR 35x15x2x3	35	15	2	3		478
TRR 35x15x2x4	35	15	2	4		470
TRR 35x18x2x9	35	18	2	9		455

\* Unless otherwise indicated, profiles are made of EN AW-6060T6 alloy  
\* All dimensions are expressed in mm

Via Newton, n.12  
20016 Pero (Milano - Italy)  
Tel. +39 02 3535955 r.a. Fax. +39 02 3539929  
E-Mail: info@omar-alluminio.it

Cataloghi Online: [www.omar-alluminio.it](http://www.omar-alluminio.it)  
[www.omar-alluminio.com](http://www.omar-alluminio.com)

CUSTOM ALUMINUM PROFILES / STANDARD / SPECIAL / AND FOR:  
ELECTRONICS / LED / PHOTOVOLTAIC / ROBOTIC AUTOMATION / PNEUMATICS / AUTOMOTIVE

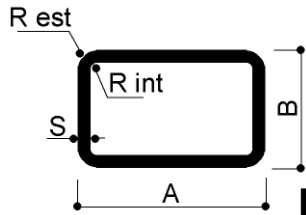

For more dimensions of rectangular tubes with rounded edges in aluminum, please visit:

[www.tubi-alluminio.it](http://www.tubi-alluminio.it)

## RADIATED RECTANGULAR TUBES

TUBI RETTANGOLARI RAGGIATI	A	B	S	R est	R int	GR/MT
TRR 35x20x1x4	35	20	1	4		270
TRR 35x20x1,2x1	35	20	1,2	1		338
TRR 35x20x1,2x1,8x3	35	20	1,2	1,8	3	330
TRR 35x20x1,2x3	35	20	1,2	3		340
TRR 35x20x1,5x1,5	35	20	1,5	1,5		416
TRR 35x20x1,5x2	35	20	1,5	2		413
TRR 35x20x1,5x3	35	20	1,5	3		405
TRR 35x20x1,5x3x0,2	35	20	1,5	3	0,2	375
TRR 35x20x1,5x3x1,5	35	20	1,5	3	1,5	405
TRR 35x20x1,5x4	35	20	1,5	4		399
TRR 35x20x2x2	35	20	2	2		541
TRR 35x20x2,3x5x2,5	35	20	2,3	5	2,5	580
TRR 35x25x1,5	35	25	1,5			430
TRR 35x25x1,5x0,2x0,3	35	25	1,5	0,2	0,3	460
TRR 35x25x1,5x3,2x1,7	35	25	1,5	3,2	1,7	447
TRR 35x25x2x0,3x0,2	35	25	2	0,3	0,2	600
TRR 35x25x2,2x1,75	35	25	2,2	1,75		456
TRR 36x18x1,8x4x2,2	36	18	1,8	4	2,2	461
TRR 36x20x1,5x3x1,5	36	20	1,5	3	1,5	413
TRR 36x20x2,5x8	36	20	2,5	8		680
TRR 37x25x1,5x4,25x3	37	25	1,5	4,25	3	452
TRR 37x26,9x1x2	37	26,9	1	2		326
TRR 37,8x19,8x1,5x4,4x2,9	37,8	19,8	1,5	4,4	2,9	417
TRR 38,5x18,5x1,4x1,5	38,5	18,5	1,4	1,5		409
TRR 39,5x24,5x4,5x3	39,5	24,5	4,5	3		1315
TRR 39,8x19,8x1,4x5,4x4	39,8	19,8	1,4	5,4	4	396
TRR 40x10x1,5x0,5x0,3	40	10	1,5	0,5	0,3	378
TRR 40x15x1,5x3x1,5	40	15	1,5	3	1,5	405
TRR 40x15x2x0,2x0,2	40	15	2	0,2	0,2	548
TRR 40x15x2,5	40	15	2,5			667
TRR 40x16x2x1,5	40	16	2	1,5		556
TRR 40x17,2x1,5x1,5x0,2	40	17,2	1,5	1,5	0,2	435
TRR 40x20x1	40	20	1			313
TRR 40x20x1,2x1,8x3	40	20	1,2	1,8	3	360
TRR 40x20x1,2x4,5	40	20	1,2	4,5		381
TRR 40x20x1,5	40	20	1,5			442
TRR 40x20x1,5x1,5	40	20	1,5	1,5		456
TRR 40x20x1,5x3x1,5	40	20	1,5	3	1,5	446
TRR 40x20x1,5x3x3	40	20	1,5	3	3	462
TRR 40x20x1,5x4	40	20	1,5	4		439
TRR 40x20x1,5x4x1,5	40	20	1,5	4	1,5	~450
TRR 40x20x1,75x4x2,25	40	20	1,75	4	2,25	509
TRR 40x20x2	40	20	2			594
TRR 40x20x2x0,5x0,5	40	20	2	0,5	0,5	600
TRR 40x20x2x1,5	40	20	2	1,5		600
TRR 40x20x2x2	40	20	2	2		605
TRR 40x20x2x2,5	40	20	2	2,5		590
TRR 40x20x2x4	40	20	2	4		577

\* Unless otherwise indicated, profiles are made of EN AW-6060T6 alloy  
\* All dimensions are expressed in mm

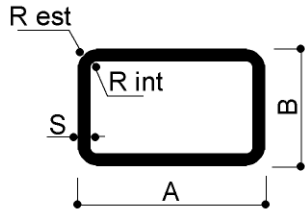

For more dimensions of rectangular tubes with rounded edges in aluminum, please visit:

[www.tubi-alluminio.it](http://www.tubi-alluminio.it)

## RADIATED RECTANGULAR TUBES

TUBI RETTANGOLARI RAGGIATI	A	B	S	R est	R int	GR/MT
TRR 40x20x2x10	40	20	2	10		521
TRR 40x20x2,5x2	40	20	2,5	2		733
TRR 40x20x2,7x2	40	20	2,7	2		787
TRR 40x20x3x0,5x0,5	40	20	3	0,5	0,5	875
TRR 40x20x3x2	40	20	3	2		866
TRR 40x20x4	40	20	4			1104
TRR 40x20x4x3	40	20	4	3		~1100
TRR 40x22x1,9x5x3,1	40	22	1,9	5	3,1	559
TRR 40x23x1,5x5	40	23	1,5	5		456
TRR 40x23x1,5x5x3,5	40	23	1,5	5	3,5	456
TRR 40x23x2x2	40	23	2	2		~500
TRR 40x25x1,2x2x0,8	40	25	1,2	2	0,8	396
TRR 40x25x2x0,3x0,3	40	25	2	0,3	0,3	660
TRR 40x25x2x2	40	25	2	2		649
TRR 40x25x2,5x1x3	40	25	2,5	1	3	791
TRR 40x25x2,25x2	40	25	2,25	2		726
TRR 40x25x2,7x9,11	40	25	2,7	9,11		747
TRR 40x25x3x0,5	40	25	3	0,5		956
TRR 40x25x5x5	40	25	5	5		1447
TRR 40x30x1,3x5x3,7	40	30	1,3	5	3,7	445
TRR 40x30x1,5	40	30	1,5			537
TRR 40x30x2x0,3x0,3	40	30	2	0,3	0,3	710
TRR 40x30x2x1,5	40	30	2	1,5		~700
TRR 40x30x2x5	40	30	2	5		676
TRR 40x30x2,5x0,2x0,5	40	30	2,5	0,2	0,5	880
TRR 40x30x3	40	30	3			1037
TRR 40x30x4x0,6x0,6	40	30	4	0,6	0,6	1320
TRR 40x30x4x4x0,2	40	30	4	4	0,2	1460
TRR 40x32x1,5x3	40	32	1,5	3		543
TRR 40x35x2,5x2,5	40	35	2,5	2,5		949
TRR 40x35x2,5x5x2,5	40	35	2,5	5	2,5	902
TRR 41x22x1,5x4	41	22	1,5	4		463
TRR 41x22x1,5x5	41	22	1,5	5		456
TRR 41,5x25x2x0,3x0,3	41,5	25	2	0,3	0,3	672
TRR 42x22x1,45x4	42	22	1,45	4		458
TRR 42x22x1,5x4	42	22	1,5	4		471
TRR 42x22x1,5x4,5x3	42	22	1,5	4,5	3	467
TRR 42x22x1,6x4	42	22	1,6	4		502
TRR 42x22x2x4,5x3,7	42	22	2	4,5	3,7	642
TRR 42x25x1,5	42	25	1,5			460
TRR 42x30x2,5x4,5x2	42	30	2,5	4,5	2	954
TRR 43x16x2x0,5	43	16	2	0,5		594
TRR 44x15x2x2,5	44	15	2	2,5		580
TRR 44,4x17,8x2x0,5	44,4	17,8	2	0,5		626
TRR 45x6x1,5x0,2	45	6	1,5	0,2		388
TRR 45x15x2,5x2	45	15	2,5	2		733
TRR 45x20x1,5x2	45	20	1,5	2		493
TRR 45x20x2,5x5	45	20	2,5	5		770

\* Unless otherwise indicated, profiles are made of EN AW-6060T6 alloy

\* All dimensions are expressed in mm

Via Newton, n.12

20016 Pero (Milano - Italy)

Tel. +39 02 3535955 r.a. Fax. +39 02 3539929

E-Mail: [info@omar-alluminio.it](mailto:info@omar-alluminio.it)

Cataloghi Online: [www.omar-alluminio.it](http://www.omar-alluminio.it)

[www.omar-alluminio.com](http://www.omar-alluminio.com)

CUSTOM ALUMINIUM PROFILES / STANDARD / SPECIAL / AND FOR:

ELECTRONICS / LED / PHOTOVOLTAIC / ROBOTIC AUTOMATION / PNEUMATICS / AUTOMOTIVE

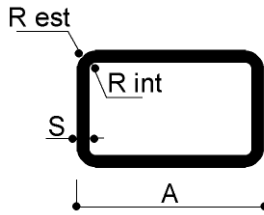

For more dimensions of rectangular tubes with rounded edges in aluminum, please visit:

[www.tubi-alluminio.it](http://www.tubi-alluminio.it)

## RADIATED RECTANGULAR TUBES

TUBI RETTANGOLARI RAGGIATI	A	B	S	R est	R int	GR/MT
TRR 45x22	45	22				737
TRR 45x22x1,5x3,5x2	45	22	1,5	3,5	2	507
TRR 45x24,8x2x1	45	24,8	2	1		707
TRR 45x25x1,5	45	25	1,5			401
TRR 45x25x2,7x9,11	45	25	2,7	9,11		747
TRR 45x30x4x1x5	45	30	4	1	5	1504
TRR 45x30x4,5x1	45	30	4,5	1		1604
TRR 45,9x26,4x1,2x1,5	45,9	26,4	1,2	1,5		448
TRR 48x25x3x2x5	48	25	3	2	5	1260
TRR 48x41x3x2,5	48	41	3	2,5		1345
TRR 49,4x12x1,2x1,7	49,4	12	1,2	1,7		392
TRR 49,6x14,6x1,8x3x1,5	49,6	14,6	1,8	3	1,5	573
TRR 49,8x21,8x1,4	49,8	21,8	1,4			~550
TRR 50x15x1,5x1	50	15	1,5	1		502
TRR 50x15x1,8x2	50	15	1,8	2		587
TRR 50x15x2,5x1,5	50	15	2,5	1,5		759
TRR 50x17x2x1	50	17	2	1		678
TRR 50x20x0,9x1	50	20	0,9	1		259
TRR 50x20x1,2	50	20	1,2			432
TRR 50x20x1,5x5	50	20	1,5	5		513
TRR 50x20x1,8x0,3	50	20	1,8	0,3		645
TRR 50x20x2x0,5x0,5	50	20	2	0,5	0,5	710
TRR 50x20x2x2x0,2	50	20	2	2		704
TRR 50x20x2x5x2	50	20	2	5	2	655
TRR 50x20x2x10	50	20	2	10		630
TRR 50x20x3x0,5x0,2	50	20	3	0,5	0,2	1040
TRR 50x20x3x0,5x0,5	50	20	3	0,5	0,5	1040
TRR 50x20x3x4x0,2	50	20	3	4	0,2	1000
TRR 50x20x4x2	50	20	4	2		1330
TRR 50x25x1,5x2x0,5	50	25	1,5	2	0,5	575
TRR 50x25x2x2	50	25	2	2		757
TRR 50x25x2x4	50	25	2	4		739
TRR 50x25x2x4x2	50	25	2	4	2	775
TRR 50x25x3x0,4	50	25	3	0,4		1118
TRR 50x26x3x0,2x0,2	50	26	3	0,2	0,2	1350
TRR 50x30x1,5x0,5	50	30	1,5	0,5		624
TRR 50x30x1,8x2	50	30	1,8	2		733
TRR 50x30x2x5x2	50	30	2	5	2	755
TRR 50x30x2,5x1x1	50	30	2,5	1	1	1010
TRR 50x30x2,5x1,5	50	30	2,5	1,5		~1000
TRR 50x30x2,7x6	50	30	2,7	6		1029
TRR 50x30x3x1,5	50	30	3	1,5		1194
TRR 50x30x3x3	50	30	3	3		1179
TRR 50x30x3x4	50	30	3	4		1200
TRR 50x30x3x6	50	30	3	6		1218
TRR 50x30x4x4x0,2	50	30	4	4	0,2	1590
TRR 50x35x1,5x2	50	35	1,5	2		655
TRR 50x40x2x0,5x0,5	50	40	2	0,5	0,5	930

\* Unless otherwise indicated, profiles are made of EN AW-6060T6 alloy

\* All dimensions are expressed in mm



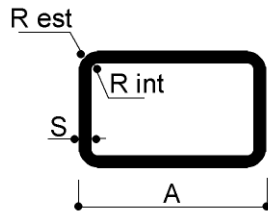

For more dimensions of rectangular tubes with rounded edges in aluminum, please visit:

[www.tubi-alluminio.it](http://www.tubi-alluminio.it)

## RADIATED RECTANGULAR TUBES

TUBI RETTANGOLARI RAGGIATI	A	B	S	R est	R int	GR/MT
TRR 50x40x2x5x3	50	40	2	5	3	892
TRR 50x40x3x5	50	40	3	5		1312
TRR 52x27x2,5x5	52	27	2,5	5		960
TRR 52x28x1,5x5	52	28	1,5	5		664
TRR 53,5x28x3x3,5x4	53,5	28	3	3,5	4	1308
TRR 54x14x1,5x0,3x0,3	54	14	1,5	0,3	0,3	523
TRR 54x40x3x1,5	54	40	3	1,5		1425
TRR 55x25x1,2x2x0,8	55	25	1,2	2	0,8	494
TRR 55x25x2x4	55	25	2	4		794
TRR 55x35x2x2,5	55	35	2	2,5		929
TRR 55x45x2,5x10	55	45	2,5	10		1180
TRR 56x22x1,2x1,8x3	56	22	1,2	1,8	3	480
TRR 57x52x2x1,5	57	52	2	1,5		1129
TRR 59x44x3x0,5x1	59	44	3	0,5	1	1600
TRR 60x10x1,5x1x0,2	60	10	1,5	1	0,2	541
TRR 60x10x1,5x3x1,5	60	10	1,5	3	1,5	527
TRR 60x12x1,3x0,3x1	60	12	1,3	0,3	1	490
TRR 60x15x2x2	60	15	2	2		760
TRR 60x20x1,2x3x1,8	60	20	1,2	3	1,8	489
TRR 60x20x1,5x2	60	20	1,5	2		615
TRR 60x20x2x3	60	20	2	3		802
TRR 60x20x2,5x2	60	20	2,5	2		1003
TRR 60x25x1,5	60	25	1,5			562
TRR 60x25x2	60	25	2			867
TRR 60x25x2x0,2x2	60	25	2	0,2	2	870
TRR 60x30x1,3x3x1,7	60	30	1,3	3	1,7	601
TRR 60x30x1,5	60	30	1,5			750
TRR 60x30x1,5x0,3x0,3	60	30	1,5	0,3	0,3	700
TRR 60x30x1,5x3	60	30	1,5	3		707
TRR 60x30x1,5x3,5x2	60	30	1,5	3,5	2	686
TRR 60x30x1,5x4	60	30	1,5	4		682
TRR 60x30x1,5x10x8,5	60	30	1,5	10	8,5	700
TRR 60x30x1,65x3,5x2	60	30	1,65	3,5	2	704
TRR 60x30x1,8x0,3x0,3	60	30	1,8	0,3	0,3	840
TRR 60x30x1,8x5	60	30	1,8	5		808
TRR 60x30x2	60	30	2			929
TRR 60x30x2x2	60	30	2	2		920
TRR 60x30x2x3	60	30	2	3		913
TRR 60x30x2x5	60	30	2	5		897
TRR 60x30x3x2	60	30	3	2		~1300
TRR 60x30x3x3	60	30	3	3		1326
TRR 60x30x3x5	60	30	3	5		1303
TRR 60x30x4x4	60	30	4	4		1734
TRR 60x30x5x1x0,2	60	30	5	1	0,2	2157
TRR 60x30x5x4,5	60	30	5	4,5		2128
TRR 60x30x7x1x0,2	60	30	7	1	0,2	2870
TRR 60x34x2x2	60	34	2	2		963
TRR 60x35x2,7x12,7	60	35	2,7	12,7		1127

\* Unless otherwise indicated, profiles are made of EN AW-6060T6 alloy  
\* All dimensions are expressed in mm

Via Newton, n.12  
20016 Pero (Milano - Italy)  
Tel. +39 02 3535955 r.a. Fax. +39 02 3539929  
E-Mail: info@omar-alluminio.it

Cataloghi Online: [www.omar-alluminio.it](http://www.omar-alluminio.it)  
[www.omar-alluminio.com](http://www.omar-alluminio.com)

CUSTOM ALUMINUM PROFILES / STANDARD / SPECIAL / AND FOR:  
ELECTRONICS / LED / PHOTOVOLTAIC / ROBOTIC AUTOMATION / PNEUMATICS / AUTOMOTIVE

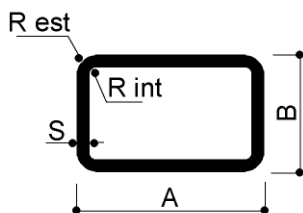

For more dimensions of rectangular tubes with rounded edges in aluminum, please visit:

[www.tubi-alluminio.it](http://www.tubi-alluminio.it)

## RADIATED RECTANGULAR TUBES

TUBI RETTANGOLARI RAGGIATI	A	B	S	R est	R int	GR/MT
TRR 60x35x3x1,5	60	35	3	1,5		1437
TRR 60x35x5x1	60	35	5	1		2293
TRR 60x40x2x0,3x0,3	60	40	2	0,3	0,3	1040
TRR 60x40x2x2	60	40	2	2		1028
TRR 60x40x2x3	60	40	2	3		1016
TRR 60x40x2,5x0,5x0,5	60	40	2,5	0,5	0,5	1283
TRR 60x40x2,5x2	60	40	2,5	2		1275
TRR 60x40x3x0,5x0,5	60	40	3	0,5	0,5	1523
TRR 60x40x3x3	60	40	3	3		~1500
TRR 60x40x3x3x1,5	60	40	3	3	1,5	1507
TRR 60x40x3x5	60	40	3	5		1474
TRR 60x40x3x8	60	40	3	8		1432
TRR 60x40x4x2x0,2	60	40	4	2	0,2	1978
TRR 60x40x4x3	60	40	4	3		1966
TRR 60x40x5x1	60	40	5	1		2428
TRR 60x50x4x3	60	50	4	3		2204
TRR 60,3x20,3x1x2,5x1,5	60,3	20,3	1	2,5	1,5	410
TRR 61x30x2	61	30	2			737
TRR 62x25x1,5x6x4,5	62	25	1,5	6	4,5	644
TRR 65x30x3x1x0,2	65	30	3	1	0,2	1440
TRR 65x32x1,8x5	65	32	1,8	5		874
TRR 65x34x3,5x4x4,5	65	34	3,5	4	4,5	1988
TRR 65x45x3x3,5	65	45	3	5		1657
TRR 65x51x5x0,5x1	65	51	5	0,5	1	2860
TRR 66x32x1,5x5	66	32	1,5	5		~1000
TRR 67x12,7x1x1,5x0,5	67	12,7	1	1,5	0,5	413
TRR 67x21x1,3x0,8x0,5	67	21	1,3	0,8	0,5	598
TRR 68x25x1,2	68	25	1,2			568
TRR 70x16x3,5x3	70	16	3,5	3		~1400
TRR 70x20x1,5x2	70	20	1,5	2		693
TRR 70x20x1,5x2x0,2	70	20	1,5	2	0,2	693
TRR 70x20x2x1	70	20	2	1		929
TRR 70x23x2x1,5	70	23	2	1,5		1062
TRR 70x23x3x1,5	70	23	3	1,5		1062
TRR 70x30x3	70	30	3			1523
TRR 70x30x3x2	70	30	3	2		1514
TRR 70x30x3x2,5x0,2	70	30	3	2,5	0,2	1509
TRR 70x30x3,2x2x0,2	70	30	3,2	2	0,2	1609
TRR 70x30x5,2x2	70	30	5,2	2		1609
TRR 70x40x3x2,5x0,2	70	40	3	2,5	0,2	1685
TRR 70x40x4x4	70	40	4	4		2168
TRR 70x50x3x1	70	50	3	1		1847
TRR 70x50x4x5x1	70	50	4	5	1	2362
TRR 70x60x3x0,7	70	60	3	0,7		2011
TRR 70,1x25x2x3x1	70,1	25	2	3	1	964
TRR 72,5x20x1,2	72,5	20	1,2			570
TRR 74x22x1,3x2,2x3,5	74	22	1,3	2,2	3,5	640
TRR 79x40x1,9x7,9	79	40	1,9	7,9		1110

\* Unless otherwise indicated, profiles are made of EN AW-6060T6 alloy  
\* All dimensions are expressed in mm

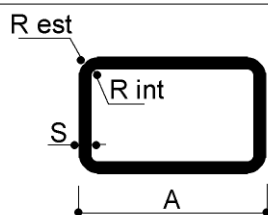

For more dimensions of rectangular tubes with rounded edges in aluminum, please visit:

[www.tubi-alluminio.it](http://www.tubi-alluminio.it)

## RADIATED RECTANGULAR TUBES

TUBI RETTANGOLARI RAGGIATI	A	B	S	R est	R int	GR/MT
TRR 79x44x3x0,5x1	79	44	3	0,5	1	1900
TRR 80x9x1,5x1	80	9	1,5	1		~600
TRR 80x12x1,5x1	80	12	1,5	1		718
TRR 80x15x1,5x0,4	80	15	1,5	0,4		745
TRR 80x20x1,2x3	80	20	1,2	3		619
TRR 80x20x1,5x2	80	20	1,5	2		902
TRR 80x20x1,5x5x3,5	80	20	1,5	5	3,5	756
TRR 80x20x1,8x5	80	20	1,8	5		899
TRR 80x20x2x0,3x0,3	80	20	2	0,3	0,3	1040
TRR 80x20x2x3	80	20	2	3		1018
TRR 80x30x1,5x2x1	80	30	1,5	2	1	826
TRR 80x30x1,5x3	80	30	1,5	3		867
TRR 80x30x1,5x3,5x2	80	30	1,5	3,5	2	859
TRR 80x30x1,5x4	80	30	1,5	4		844
TRR 80x30x2x2,5x2,5	80	30	2	2,5	2,5	1145
TRR 80x30x3x0,2x0,2	80	30	3	0,2	0,2	1680
TRR 80x30x3x2	80	30	3	2		1684
TRR 80x30x4,5x4,5x0,2	80	30	4,5	4,5	0,2	2407
TRR 80x34x1,5x1	80	34	1,5	1		899
TRR 80x35x3x4	80	35	3	4		1766
TRR 80x40x1,5	80	40	1,5			950
TRR 80x40x2x0,3x0,5	80	40	2	0,3	0,5	1250
TRR 80x40x2x2	80	40	2	2		1245
TRR 80x40x2x3	80	40	2	3		1234
TRR 80x40x2x4	80	40	2	4		1210
TRR 80x40x2,5x0,4x0,4	80	40	2,5	0,4	0,4	1550
TRR 80x40x3x0,5x0,5	80	40	3	0,5	0,5	1850
TRR 80x40x3x2,5	80	40	3	2,5		1833
TRR 80x40x3x3	80	40	3	3		1828
TRR 80x40x3x3x1	80	40	3	3	1	1828
TRR 80x40x3x6	80	40	3	6		1784
TRR 80x40x4x0,6x0,6	80	40	4	0,6	0,6	2420
TRR 80x40x4x3x0,1	80	40	4	3	0,1	~2400
TRR 80x40x4x3x1	80	40	4	3	1	2400
TRR 80x50x2x0,3x0,3	80	50	2	0,3	0,3	1360
TRR 80x50x3x6	80	50	3	6		1947
TRR 80x50x4x0,6x0,6	80	50	4	0,6	0,6	2640
TRR 80x50x4x3	80	50	4	3		2615
TRR 80x50x4x4	80	50	4	4		2598
TRR 80x50x5x5x0,2	80	50	5	5	0,2	~2800
TRR 80x60x3x0,5x0,5	80	60	3	0,5	0,5	2170
TRR 80x60x4x0,6x0,6	80	60	4	0,6	0,6	2851
TRR 85x27x1,8x2x1	85	27	1,8	2	1	1061
TRR 85x30x4x0,2x0,2	85	30	4	0,2	0,2	2430
TRR 87,8x26,4x1,2x1,5	87,8	26,4	1,2	1,5		720
TRR 90x20x1,4x3,5	90	20	1,4	3,5		792
TRR 90x30x1,8x3	90	30	1,8	3		1114
TRR 90x30x2x10	90	30	2	10		1234
TRR 90x80x3x6	90	80	3	6		2595

\* Unless otherwise indicated, profiles are made of EN AW-6060T6 alloy  
 \*\* All dimensions are expressed in mm



Cataloghi Online: [www.omar-alluminio.it](http://www.omar-alluminio.it)  
[www.omar-alluminio.com](http://www.omar-alluminio.com)

CUSTOM ALUMINUM PROFILES / STANDARD / SPECIAL / AND FOR:  
 ELECTRONICS / LED / PHOTOVOLTAIC / ROBOTIC AUTOMATION / PNEUMATICS / AUTOMOTIVE

Via Newton, n.12  
 20016 Pero (Milano - Italy)  
 Tel. +39 02 3535955 r.a. Fax. +39 02 3539929  
 E-Mail: [info@omar-alluminio.it](mailto:info@omar-alluminio.it)

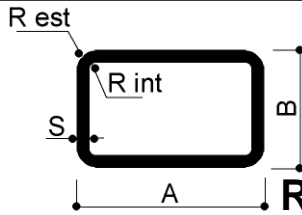

For more dimensions of rectangular tubes with rounded edges in aluminum, please visit:

[www.tubi-alluminio.it](http://www.tubi-alluminio.it)

## RADIATED RECTANGULAR TUBES

TUBI RETTANGOLARI RAGGIATI	A	B	S	R est	R int	GR/MT
TRR 90x80x7x2	90	80	7	2		5897
TRR 91x47x4x5x6	91	47	4	5	6	3270
TRR 95x30x2x2,5	95	30	2	2,5		1293
TRR 97x23x3x6	97	23	3	6		1791
TRR 99x44x3x0,5x1	99	44	3	0,5	1	2220
TRR 100x18x1,7x3x0,4	100	18	1,7	3	0,4	1073
TRR 100x20x1,2x3	100	20	1,2	3		748
TRR 100x20x2x3	100	20	2	3		1234
TRR 100x23x1,5x3	100	23	1,5	3		956
TRR 100x25x1,2x0,2x0,3	100	25	1,2	0,2	0,3	790
TRR 100x25x1,3x3	100	25	1,3	3		847
TRR 100x25x1,5x2x0,5	100	25	1,5	2	0,5	980
TRR 100x25x1,7x3x3	100	25	1,7	3	3	1096
TRR 100x25x1,8x2x0,2	100	25	1,8	2	0,2	1180
TRR 100x25x1,8x3	100	25	1,8	3		1120
TRR 100x25x2x0,3x0,3	100	25	2	0,3	0,3	1304
TRR 100x25x2,5x2	100	25	2,5	2		1585
TRR 100x30x2x2,5x1	100	30	2	2,5	1	1349
TRR 100x30x4x2	100	30	4	2		2627
TRR 100x40x1,5/3,3x4	100	40	1,5/3,3	4		1441
TRR 100x40x4	100	40	4			2851
TRR 100x40x4x0,6x0,6	100	40	4	0,6	0,6	2851
TRR 100x40x4x6	100	40	4	6		2797
TRR 100x50x2x0,3x0,3	100	50	2	0,3	0,3	1580
TRR 100x50x3x2	100	50	3	2		2324
TRR 100x50x3x2x0,3	100	50	3	2	0,3	2340
TRR 100x50x3x4	100	50	3	4		2300
TRR 100x50x4x4	100	50	4	4		3030
TRR 100x50x5x0,5	100	50	5	0,5		3780
TRR 100x50x5x2x1	100	50	5	2	1	3771
TRR 100x54x1,5x3x1,5	100	54	1,5	3	1,5	1207
TRR 100x55x3x8x5	100	55	3	8	5	2325
TRR 100x60x3x2x5	100	60	3	2	5	2450
TRR 100x60x3x3x5	100	60	3	3	5	3152
TRR 100x60x6x7	100	60	6	7		4684
TRR 100x80x3x1x1	100	80	3	1	1	2819
TRR 102x59,2x8x1	102	59,2	8	1		6273
TRR 103x53x4x4x8	103	53	4	4	8	3080
TRR 108x40x1,5x2,5x4	108	40	1,5	2,5	4	1170
TRR 109x41x2x2x4	109	41	2	2	4	1550
TRR 110x70x4x10x6	110	70	4	10	6	3568
TRR 110x70x5x10x5	110	70	5	10	5	4465
TRR 118x44x3x0,5x1	118	44	3	0,5	1	1520
TRR 120x15x1,8x5x3,2	120	15	1,8	5	3,2	1243
TRR 120x20x1,5x1	120	20	1,5	1		1107
TRR 120x20x1,5x3	120	20	1,5	3		1094
TRR 120x20x2x2	120	20	2	2		1460
TRR 120x25	120	25				1515
TRR 120x30x2x0,3	120	30	2	0,3		1577

\* Unless otherwise indicated, profiles are made of EN AW-6060T6 alloy  
\* All dimensions are expressed in mm

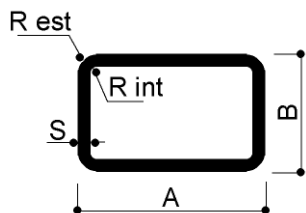

For more dimensions of rectangular tubes with rounded edges in aluminum, please visit:

[www.tubi-alluminio.it](http://www.tubi-alluminio.it)

## RADIATED RECTANGULAR TUBES

TUBI RETTANGOLARI RAGGIATI	A	B	S	R est	R int	GR/MT
TRR 120x30x2x5	120	30	2	5		1540
TRR 120x40x2x0,2x0,5	120	40	2	0,2	0,5	1680
TRR 120x50x4x0,6x0,6	120	50	4	0,6	0,6	3500
TRR 120x60x1,7x3	120	60	1,7	3		1604
TRR 120x60x2x5	120	60	2	5		1864
TRR 120x60x5x7	120	60	5	7		4484
TRR 120x70x3x10x7	120	70	3	10	7	2862
TRR 120x80x4x1x0,5	120	80	4	1	0,5	4149
TRR 120x80x6x3	120	80	6	3		6078
TRR 123x63x4,5x6x10,5	123	63	4,5	6	10,5	5087
TRR 125x52,5x2x3	125	52,5	2	3		2338
TRR 130x30x1,8x5x3,2	130	30	1,8	5	3,2	1486
TRR 130x70x3x2x1	130	70	3	2	1	3134
TRR 132x28x2x1	132	28	2	1		~1700
TRR 138x44x3x0,5x1	138	44	3	0,5	1	2850
TRR 140x17,8x2,75x0,5	140	17,8	2,75	0,5		2259
TRR 140x25x2,5x5x2,5	140	25	2,5	5	2,5	2116
TRR 140x25x2,9x1	140	25	2,9	1		2500
TRR 140x40x6x0,5	140	40	6	0,5		5443
TRR 140x60x6x6x2	140	60	6	6	2	6016
TRR 140x80x7x1	140	80	7	1		7787
TRR 140x90x4x1x0,5	140	90	4	1	0,5	4797
TRR 140x110x5x2,5	140	110	5	2,5		6467
TRR 149,5x85x9,5x15,2	149,5	85	9,5	15,2		9289
TRR 150x25x2x3	150	25	2	3		1828
TRR 150x25x2,5x6x3,5	150	25	2,5	6	3,5	2240
TRR 150x35x2,5x1,5x0,5	150	35	2,5	1,5	0,5	2425
TRR 150x50x2x5	150	50	2	5		2083
TRR 150x50x4x0,6x0,6	150	50	4	0,6	0,6	4150
TRR 150x50x5	150	50	5			5130
TRR 150x50x5x2,5x0,5	150	50	5	2,5	0,5	5117
TRR 150x100x15x1	150	100	15	1		17820
TRR 160x25x3,5x5x2	160	25	3,5	5	2	3410
TRR 160x50x4x4	160	50	4	4		4326
TRR 160x80x2,5x5x0,8	160	80	2,5	5	0,8	2956
TRR 167x30x2,5x1,5	167	30	2,5	1,5		2654
TRR 180x60x2,5x4	180	60	2,5	4		3141
TRR 180x125x4x10	180	125	4	10		6415
TRR 190x80x2,5x1	190	80	2,5	1		3578
TRR 197x97x8,50	197	97	8,5			12714
TRR 200x40x2,5	200	40	2,5			3173
TRR 200x62x3,5x11x7,5	200	62	3,5	11	7,5	4650
TRR 200x63x3x1	200	63	3	1		4163
TRR 200x80x4x0,5	200	80	4	0,5		5875
TRR 200x80x5x1	200	80	5	1		7291
TRR 200x100x2,5x1x1	200	100	2,5	1	1	3980
TRR 200x100x4x0,5x0,5	200	100	4	0,5	0,5	6310
TRR 200x100x8	200	100	8			12360
TRR 200x125x3x4	200	125	3	4		5133

\* Unless otherwise indicated, profiles are made of EN AW-6060T6 alloy

\* All dimensions are expressed in mm

Via Newton, n. 12  
20016 Pero (Milano - Italy)  
Tel. +39 02 3535955 r.a. Fax. +39 02 3539929  
E-Mail: info@omar-alluminio.it

Cataloghi Online: [www.omar-alluminio.it](http://www.omar-alluminio.it)  
[www.omar-alluminio.com](http://www.omar-alluminio.com)  
CUSTOM ALUMINUM PROFILES / STANDARD / SPECIAL / AND FOR:  
ELECTRONICS / LED / PHOTOVOLTAIC / ROBOTIC AUTOMATION / PNEUMATICS / AUTOMOTIVE



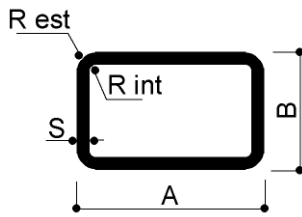

For more dimensions of rectangular tubes with rounded edges in aluminum, please visit:

[www.tubi-alluminio.it](http://www.tubi-alluminio.it)

## RADIATED RECTANGULAR TUBES

TUBI RETTANGOLARI RAGGIATI	A	B	S	R est	R int	GR/MT
TRR 200x140x8	200	140	8			13730
TRR 200x150x3x0,5x3,5	200	150	3	0,5	3,5	5540
TRR 200x160x8x20	200	160	8	20		14267
TRR 205x100x2,7x4	205	100	2,7	4		4335
TRR 210x60x4,8x9	210	60	4,8	9		6605
TRR 210x134x10x1	210	134	10	1		17496
TRR 220x70x5x8x3	220	70	5	8	3	7433
TRR 220x140x4x1	220	140	4	1		7603
TRR 238x140,5x10x10	238	140,5	10	10		19127
TRR 240x60x4x0,5	240	60	4	0,5		~6500
TRR 250x100x4x0,8x0,8	250	100	4	0,8	0,8	7390
TRR 250x100x10x10	250	100	10	10		17640
TRR 250x120x8,8x1	250	120	8,8	1		16746
TRR 262x122x4x1x1	262	122	4	1	1	8119
TRR 265x120x4x12	265	120	4	12		7958
TRR 280x100x3x0,5	280	100	3	0,5		6059
TRR 280x160x4x5x1	280	160	4	5	1	9275
TRR 300x60x8x2	300	60	8	2		14861
TRR 300x80x3x2,5	300	80	3	2,5		6558
TRR 300x110x4x1x1	300	110	4	1	1	8683
TRR 300x120x5x2,5x1	300	120	5	2,5	1	11057
TRR 300x200x6x0,5	300	200	6	0,5		15810
TRR 340x150x20x10	340	150	20	10		48420
TRR 420x150x5x0,5	420	150	5	0,5		15123

\* Unless otherwise indicated, profiles are made of EN AW-6060T6 alloy

\* All dimensions are expressed in mm

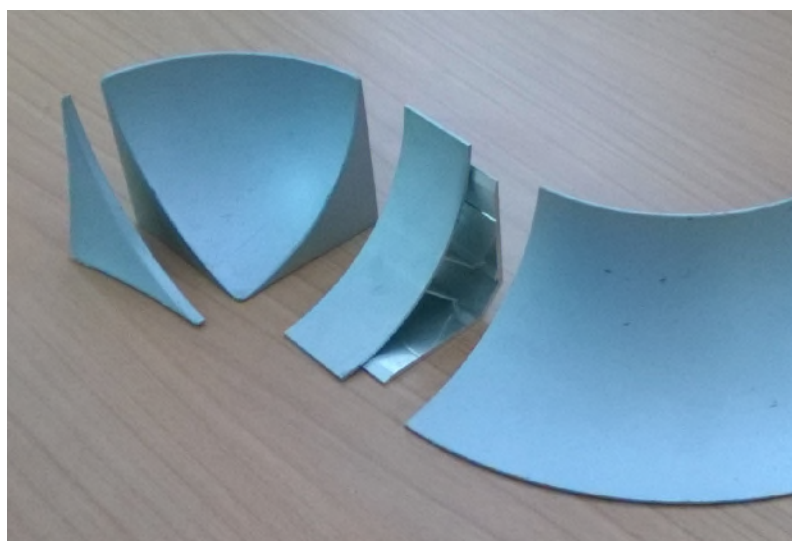

EXAMPLE PHOTO: SKIRTING BOARDS, SKIRTING BOARDS, SHELLS EXTRUDED AND SILVER ANODIZED

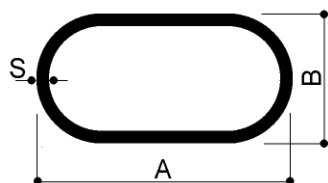

For more sizes of semi-circular aluminum radial tubes, please visit:

[www.tubi-alluminio.it](http://www.tubi-alluminio.it)

## SEMICIRCULAR TUBES

TUBI SEMICIRCOLARI	A	B	S	GR/MT	TUBI SEMICIRCOLARI	A	B	S	GR/MT
TS 12,6x8,3x2	12,6	8,3	2	153	TS 38x10x1	38	10	1	227
TS 14,8x9,4x2	14,8	9,4	2	184	TS 38x20x2	38	20	2	500
TS 20x10x1,5	20	10	1,5	195	TS 40x10x1	40	10	1	238
TS 20x15x1	20	15	1	143	TS 40x20x1,4	40	20	1,4	373
TS 20,5x13x2,75	20,5	13	2,75	350	TS 40x20x1,5	40	20	1,5	397
TS 22x12x1,4	22	12	1,4	164	TS 40x20x2	40	20	2	521
TS 22x12x2	22	12	2	278	TS 40x20x3	40	20	3	757
TS 22,5x15,25x1,6	22,5	15,25	1,6	247	TS 41,8x22x1,5	41,8	22	1,5	419
TS 23x15x1,5	23	15	1,5	237	TS 42x22x1,5	42	22	1,5	424
TS 24,2x11,6x1,2	24,2	11,6	1,2	187	TS 42x22x2,5	42	22	2,5	683
TS 24,6x14,6x1,8	24,6	14,6	1,8	322	TS 42x22,5	42	22,5		424
TS 25x10x1,2	25	10	1,2	186	TS 43,4x18,4x2,5	43,4	18,4	2,5	672
TS 25x10x1,5	25	10	1,5	229	TS 43,7x8,8x1,2	43,7	8,8	1,2	306
TS 25x10x1,8	25	10	1,8	270	TS 44x20x1,5	44	20	1,5	432
TS 26x6x1,5	26	6	1,5	218	TS 44,5x7,8x1,1	44,5	7,8	1,1	278
TS 26x14,5x2	26	14,5	2	395	TS 45x8x1,2	45	8	1,2	~270
TS 26x16x1	26	16	1	184	TS 45x15x2	45	15	2	556
TS 26x16x1,5	26	16	1,5	265	TS 45x18x1,8	45	18	1,8	511
TS 26x16x2	26	16	2	345	TS 45x23x2	45	23	2	594
TS 29x19x1	29	19	1	207	TS 48x22x2	48	22	2	621
TS 29,3x17,5x1,5	29,3	17,5	1,5	299	TS 49x10,5	49	10,5		483
TS 30x7,7x1,6	30	7,7	1,6	275	TS 49,5x9,95x1,1	49,5	9,95	1,1	315
TS 30x14,5x1,7	30	14,5	1,7	326	TS 50x8x1	50	8	1	286
TS 30x15x1,2	30	15	1,2	238	TS 50x9x1,4	50	9	1,4	391
TS 30x15x1,5	30	15	1,5	293	TS 50x10x0,9	50	10	0,9	280
TS 30x15x2	30	15	2	382	TS 50x10x0,95	50	10	0,95	265
TS 30x16x2	30	16	2	388	TS 50x10x1	50	10	1	292
TS 30x18x1,5	30	18	1,5	305	TS 50x10x1,1	50	10	1,1	327
TS 30x18x2	30	18	2	395	TS 50x10x1,2	50	10	1,2	348
TS 30x18,5x2,25	30	18,5	2,25	451	TS 50x10x1,25	50	10	1,25	363
TS 30x19x1,5	30	19	1,5	312	TS 50x10x1,3	50	10	1,3	378
TS 30x19x2,2	30	19	2,2	445	TS 50x10x1,40	50	10	1,4	405
TS 30x19x4	30	19	4	747	TS 50x20x1,35	50	20	1,35	432
TS 31x13,1x1,5	31	13,1	1,5	286	TS 50x20x1,5	50	20	1,5	478
TS 31x21x2	31	21	2	432	TS 50x20x2	50	20	2	629
TS 32x21,6x2,3	32	21,6	2,3	540	TS 50x20x3	50	20	3	920
TS 32x21,6x2,5	32	21,6	2,5	545	TS 50x25x1,75	50	25	1,75	581
TS 32x24x3	32	24	3	664	TS 50x25x2	50	25	2	660
TS 34,6x24,6x2,3	34,6	24,6	2,3	559	TS 50x25x2,5	50	25	2,5	810
TS 35x18x2	35	18	2	455	TS 50x25x3	50	25	3	964
TS 35x20x1,5	35	20	1,5	356	TS 50x25x4	50	25	4	1252
TS 35x20,2x1,6	35	20,2	1,6	380	TS 50x30x1,5	50	30	1,5	525
TS 36x18x1,5	36	18	1,5	350	TS 50x30x2	50	30	2	691
TS 36x18x2	36	18	2	505	TS 50,1x10,1x1,45	50,1	10,1	1,45	419
TS 36x18x2,5	36	18	2,5	530	TS 52x26x1,4	52	26	1,4	489

\* Unless otherwise indicated, profiles are made of EN AW-6060T6 alloy

\* All dimensions are expressed in mm

Via Newton, n. 12  
20016 Pero (Milano - Italy)  
Tel. +39 02 3535955 r.a. Fax. +39 02 3539929  
E-Mail: info@omar-alluminio.it

Cataloghi Online: [www.omar-alluminio.it](http://www.omar-alluminio.it)  
[www.omar-alluminio.com](http://www.omar-alluminio.com)  
CUSTOM ALUMINUM PROFILES / STANDARD / SPECIAL / AND FOR:  
ELECTRONICS / LED / PHOTOVOLTAIC / ROBOTIC AUTOMATION / PNEUMATICS / AUTOMOTIVE



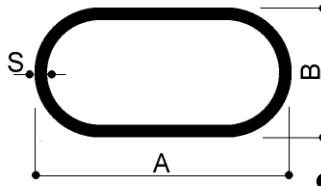

For more sizes of semi-circular aluminum radial tubes, please visit:

[www.tubi-alluminio.it](http://www.tubi-alluminio.it)

## SEMICIRCULAR TUBES

TUBI SEMICIRCOLARI	A	B	S	GR/MT	TUBI SEMICIRCOLARI	A	B	S	GR/MT
TS 59,5x38,5x8,5	59,5	38,5	8,5	3124	TS 74,9x64,9x1,7	74,9	64,9	1,7	1003
TS 60x10x1	60	10	1	346	TS 77x22x1,5	77	22	1,5	706
TS 60x10x1,1	60	10	1,1	380	TS 80x10	80	10		587
TS 60x10x1,2	60	10	1,2	413	TS 80x15x1,8	80	15	1,8	833
TS 60x10x1,3	60	10	1,3	449	TS 80x40x4	80	40	4	2084
TS 62x12x1,2	62	12	1,2	435	TS 90x36x2	90	36	2	1158
TS 65x10x1	65	10	1	373	TS 100x40x4	100	40	4	2516
TS 65x10x1,1	65	10	1,1	420	TS 110x26x3	110	26	3	1945
TS 65x10x1,25	65	10	1,25	464	TS 120x33x1,8	120	33	1,8	1322
TS 65x10x1,3	65	10	1,3	481	TS 160x80x3	160	80	3	3255
TS 65x20x1,5	65	20	1,5	603	TS 180x55x2,5	180	55	2,5	2801
TS 70x27x2	70	27	2	889	TS 181x111,5x3,5	181	111,5	3,5	4527
TS 70x40x2	70	40	2	970	TS 260x100x10	260	100	10	16270
TS 70x40x5	70	40	5	2294					

\* Unless otherwise indicated, profiles are made of EN AW-6060T6 alloy  
\* All dimensions are expressed in mm

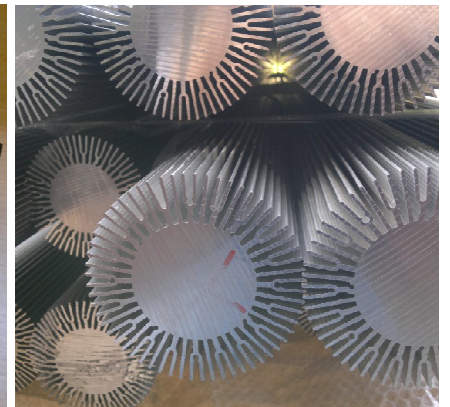
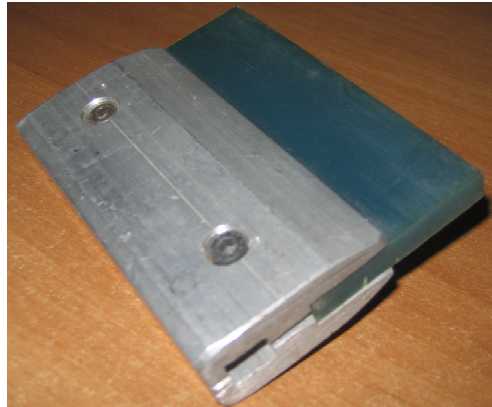
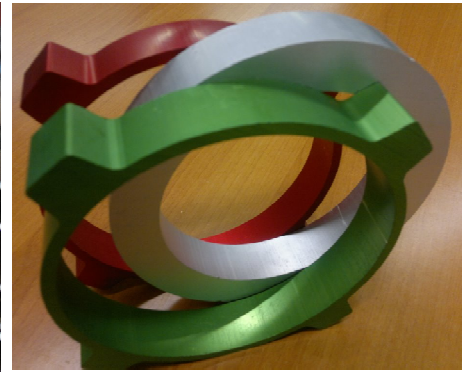
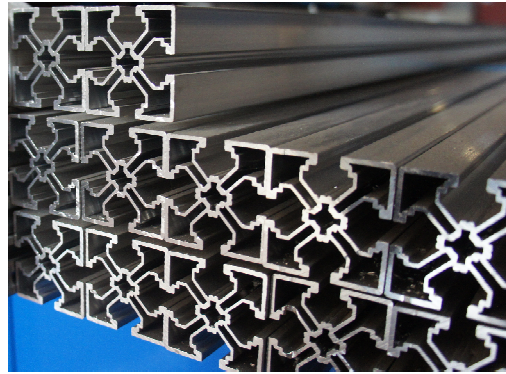
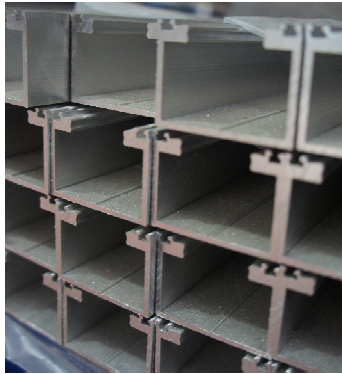

EXAMPLE PHOTO: VARIOUS CUSTOM EXTRUDED PROFILES



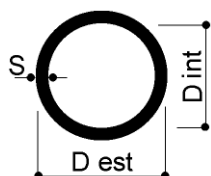

For more sizes of round aluminum tubes visit the site:

[www.tubi-alluminio.it](http://www.tubi-alluminio.it)

## ROUND TUBES

TUBI TONDI	D est	D int	S	GR/MT	TUBI TONDI	D est	D int	S	GR/MT
TT 4x2	4	2	1	25	TT 10x8	10	8	1	76
TT 5x3	5	3	1	34	TT 10x8,40	10	8,4	0,8	63
TT 5,5x3,5	5,5	3,5	1	38	TT 10x8,50	10	8,5	0,75	60
TT 5,75x3,95	5,75	3,95	0,9	37	TT 11x5	11	5	3	203
TT 5,9x2,90	5,9	2,9	1,5	55	TT 11x6	11	6	2,5	180
TT 6x3	6	3	1,5	57	TT 11x7	11	7	2	152
TT 6x3,30	6	3,3	1,35	53	TT 11x8	11	8	1,5	121
TT 6x4	6	4	1	42	TT 11x8,50	11	8,5	1,25	104
TT 6x4,4	6	4,4	0,8	42	TT 11x9	11	9	1	85
TT 7x3	7	3	2	85	TT 11,5x8	11,5	8	1,75	145
TT 7x4	7	4	1,5	70	TT 11,5x9,50	11,5	9,5	1	86
TT 7x4,80	7	4,8	1,1	54	TT 11,56x9,56	11,56	9,56	1	89
TT 7x5	7	5	1	52	TT 11,8x9,20	11,8	9,2	1,3	116
TT 7,5x5,50	7,5	5,5	1	57	TT 11,8x9,80	11,8	9,8	1	92
TT 7,7x4,30	7,7	4,3	1,7	90	TT 12x3	12	3	4,5	289
TT 7,8x6	7,8	6	0,9	53	TT 12x4,50	12	4,5	3,75	265
TT 7,85x6,25	7,85	6,25	0,8	54	TT 12x4,60	12	4,6	3,7	259
TT 8x2,7	8	2,7	2,65	120	TT 12x5	12	5	3,5	252
TT 8x3	8	3	2,5	116	TT 12x5,10	12	5,1	3,45	250
TT 8x3,20	8	3,2	2,4	114	TT 12x5,4	12	5,4	3,3	246
TT 8x3,30	8	3,3	2,35	113	TT 12x6	12	6	3	230
TT 8x4	8	4	2	102	TT 12x6,50	12	6,5	2,75	216
TT 8x4,40	8	4,4	1,8	98	TT 12x7	12	7	2,5	203
TT 8x5	8	5	1,5	83	TT 12x7,25	12	7,25	2,375	194
TT 8x5,70	8	5,7	1,15	67	TT 12x8	12	8	2	170
TT 8x6	8	6	1	59	TT 12x8,60	12	8,6	1,7	149
TT 8x6,20	8	6,2	0,9	54	TT 12x9	12	9	1,5	135
TT 8x6,50	8	6,5	0,75	49	TT 12x10	12	10	1	93
TT 8,2x6,2	8,2	6,2	1	61	TT 12x10,20	12	10,2	0,9	84
TT 9x3,40	9	3,4	2,8	147	TT 12x10,40	12	10,4	0,8	75
TT 9x4	9	4	2,5	150	TT 13x6,50	13	6,5	3,25	269
TT 9x6	9	6	1,5	84	TT 13x9	13	9	2	187
TT 9x7	9	7	1	81	TT 13x10	13	10	1,5	146
TT 9,5x6,50	9,5	6,5	1,5	103	TT 13x10,40	13	10,4	1,3	129
TT 9,5x7	9,5	7	1,25	86	TT 13x10,5	13	10,5	1,25	125
TT 9,6x7,6	9,6	7,6	1	70	TT 13x10,80	13	10,8	1,1	111
TT 9,7x4,7	9,7	4,7	2,5	153	TT 13x11	13	11	1	102
TT 9,8x7,80	9,8	7,8	1	74	TT 13,5x11,50	13,5	11,5	1	105
TT 9,8x7,90	9,8	7,9	0,95	70	TT 13,85x11,35	13,85	11,35	1,25	132
TT 10x3,20	10	3,2	3,4	192	TT 13,95x11,95	13,95	11,95	1	109
TT 10x4,20	10	4,2	2,9	176	TT 14x4,20	14	4,2	4,9	378
TT 10x5	10	5	2,5	159	TT 14x4,50	14	4,5	4,75	372
TT 10x5,40	10	5,4	2,3	152	TT 14x4,70	14	4,7	4,65	368
TT 10x6	10	6	2	136	TT 14x6	14	6	4	339
TT 10x6,90	10	6,9	1,55	111	TT 14x7	14	7	3,5	312
TT 10x7	10	7	1,5	108	TT 14x8	14	8	3	281
TT 10x7,50	10	7,5	1,25	95	TT 14x9	14	9	2,5	244

\* Unless otherwise indicated, profiles are made of EN AW-6060T6 alloy

\* All dimensions are expressed in mm

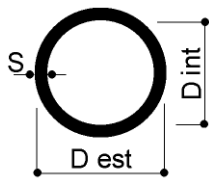

For more sizes of round aluminum tubes visit the site:

[www.tubi-alluminio.it](http://www.tubi-alluminio.it)

## ROUND TUBES

TUBI TONDI	D est	D int	S	GR/MT	TUBI TONDI	D est	D int	S	GR/MT
TT 14x10	14	10	2	204	TT 16x13,40	16	13,4	1,3	164
TT 14x10,2	14	10,2	1,9	195	TT 16x13,50	16	13,5	1,25	157
TT 14x10,30	14	10,3	1,85	191	TT 16x13,60	16	13,6	1,2	150
TT 14x10,40	14	10,4	1,8	188	TT 16x13,80	16	13,8	1,1	137
TT 14x10,50	14	10,5	1,75	181	TT 16x14	16	14	1	127
TT 14x11	14	11	1,5	159	TT 16x14,20	16	14,2	0,9	115
TT 14x11,40	14	11,4	1,3	135	TT 16,1x13,70	16,1	13,7	1,2	152
TT 14x12	14	12	1	110	TT 16,2x13,60	16,2	13,6	1,3	165
TT 14x12,10	14	12,1	0,95	105	TT 16,6x4,50	16,6	4,5	6,05	541
TT 14x12,20	14	12,2	0,9	100	TT 16,6x5,6	16,6	5,6	5,5	518
TT 14x12,40	14	12,4	0,8	89	TT 16,6x6,60	16,6	6,6	5	492
TT 14,3x9	14,3	9	2,65	263	TT 16,6x8,30	16,6	8,3	4,15	438
TT 14,5x5,50	14,5	5,5	4,5	168	TT 16,6x9,30	16,6	9,3	3,65	401
TT 14,5x6,90	14,5	6,9	3,8	345	TT 16,6x10	16,6	10	3,3	372
TT 15x6,24	15	6,24	4,38	~360	TT 16,6x10,60	16,6	10,6	3	346
TT 15x6,60	15	6,6	4,2	385	TT 17x9	17	9	4	440
TT 15x8,50	15	8,5	3,25	324	TT 17x11	17	11	3	356
TT 15x9	15	9	3	305	TT 17x12	17	12	2,5	308
TT 15x10	15	10	2,5	266	TT 17x14	17	14	1,5	197
TT 15x11	15	11	2	221	TT 17x15	17	15	1	135
TT 15x11,40	15	11,4	1,8	202	TT 17,3x11	17,3	11	3,15	378
TT 15x12	15	12	1,5	172	TT 17,5x8	17,5	8	4,75	514
TT 15x12,60	15	12,6	1,2	140	TT 17,5x15,50	17,5	15,5	1	141
TT 15x13	15	13	1	119	TT 17,6x15	17,6	15	1,3	180
TT 15,2x12,10	15,2	12,1	1,55	179	TT 17,8x15,80	17,8	15,8	1	143
TT 15,7x5,50	15,7	5,5	5,1	459	TT 18x6,80	18	6,8	5,6	588
TT 15,8x12	15,8	12	1,9	229	TT 18x8,20	18	8,2	4,9	545
TT 15,8x13,80	15,8	13,8	1	125	TT 18x9	18	9	4,5	516
TT 15,9x6,50	15,9	6,5	4,7	447	TT 18x10	18	10	4	475
TT 15,9x12,90	15,9	12,9	1,5	184	TT 18x11,50	18	11,5	3,25	406
TT 16x3,70	16	3,7	6,15	513	TT 18x12	18	12	3	381
TT 16x4,50	16	4,5	5,75	499	TT 18x12,6	18	12,6	2,7	350
TT 16x4,70	16	4,7	5,65	496	TT 18x13	18	13	2,5	329
TT 16x4,80	16	4,8	5,6	496	TT 18x14	18	14	2	271
TT 16x5	16	5	5,5	490	TT 18x14,50	18	14,5	1,75	241
TT 16x6	16	6	5	464	TT 18x15	18	15	1,5	210
TT 16x7,26	16	7,26	4,37	431	TT 18x15,60	18	15,6	1,2	171
TT 16x8	16	8	4	407	TT 18x15,70	18	15,7	1,15	143
TT 16x8,40	16	8,4	3,8	391	TT 18x16	18	16	1	144
TT 16x9	16	9	3,5	371	TT 18,1x12,50	18,1	12,5	2,8	363
TT 16x10	16	10	3	331	TT 18,5x13	18,5	13	2,75	367
TT 16x10,40	16	10,4	2,8	314	TT 18,5x14	18,5	14	2,25	310
TT 16x11	16	11	2,5	286	TT 18,6x16,40	18,6	16,4	1,1	163
TT 16x11,40	16	11,4	2,3	267	TT 18,85x13,25	18,85	13,25	2,8	381
TT 16x12	16	12	2	238	TT 18,9x12,50	18,9	12,5	3,2	426
TT 16x12,40	16	12,4	1,8	225	TT 19x8	19	8	5,5	629
TT 16x13	16	13	1,5	184	TT 19x9	19	9	5	~600

\* Unless otherwise indicated, profiles are made of EN AW-6060T6 alloy

\* All dimensions are expressed in mm

Via Newton, n.12  
20016 Pero (Milano - Italy)  
Tel. +39 02 3535955 r.a. Fax. +39 02 3539929  
E. Mail: info@omar-alluminio.it

Cataloghi Online: [www.omar-alluminio.it](http://www.omar-alluminio.it)  
[www.omar-alluminio.com](http://www.omar-alluminio.com)

CUSTOM ALUMINIUM PROFILES / STANDARD / SPECIAL / AND FOR:  
ELECTRONICS / LED / PHOTOVOLTAIC / ROBOTIC AUTOMATION / PNEUMATICS / AUTOMOTIVE

**OMAR** s.r.l.  
PROFILATI ALLUMINIO  
ALTA TECNOLOGIA

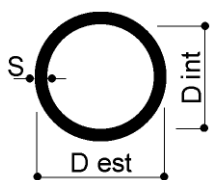

For more sizes of round aluminum tubes visit the site:

[www.tubi-alluminio.it](http://www.tubi-alluminio.it)

## ROUND TUBES

TUBI TONDI	D est	D int	S	GR/MT	TUBI TONDI	D est	D int	S	GR/MT
TT 19x11	19	11	4	288	TT 22x10,50	22	10,5	5,75	791
TT 19x12	19	12	3,5	460	TT 22x12	22	12	5	721
TT 19x13	19	13	3	407	TT 22x12,50	22	12,5	4,75	695
TT 19x15	19	15	2	288	TT 22x13	22	13	4,5	668
TT 19x16	19	16	1,5	223	TT 22x14	22	14	4	633
TT 19x16,40	19	16,4	1,3	195	TT 22x15	22	15	3,5	549
TT 19x16,60	19	16,6	1,2	195	TT 22x16	22	16	3	483
TT 19x17	19	17	1	152	TT 22x16,40	22	16,4	2,8	456
TT 19,5x15	19,5	15	2,25	329	TT 22x16,60	22	16,6	2,7	443
TT 19,5x17,5	19,5	17,5	1	157	TT 22x17	22	17	2,5	414
TT 19,95x17,40	19,95	17,4	1,275	200	TT 22x17,50	22	17,5	2,25	377
TT 19,9x14,50	19,9	14,5	2,7	393	TT 22x18	22	18	2	339
TT 20x6	20	6	7	772	TT 22x19	22	19	1,5	261
TT 20x6,80	20	6,8	6,6	758	TT 22x19,20	22	19,2	1,4	244
TT 20x7	20	7	6,5	744	TT 22x19,40	22	19,4	1,3	226
TT 20x8	20	8	6	713	TT 22x19,60	22	19,6	1,2	213
TT 20x8,50	20	8,5	5,75	695	TT 22x19,80	22	19,8	1,1	194
TT 20x9	20	9	5,5	676	TT 22x20	22	20	1	178
TT 20x10	20	10	5	636	TT 22x20,40	22	20,4	0,8	143
TT 20x10,20	20	10,2	4,9	627	TT 22,1x12	22,1	12	5,05	730
TT 20x10,30	20	10,3	4,85	623	TT 22,1x20,10	22,1	20,1	1	179
TT 20x11	20	11	4,5	592	TT 22,2x20,2	22,2	20,2	1	181
TT 20x12	20	12	4	543	TT 22,3x14,30	22,3	14,3	4	621
TT 20x13	20	13	3,5	490	TT 22,3x16,50	22,3	16,5	2,9	477
TT 20x14	20	14	3	433	TT 22,3x19	22,3	19	1,65	289
TT 20x15	20	15	2,5	371	TT 22,4x19,1	22,4	19,1	1,65	390
TT 20x16	20	16	2	306	TT 22,5x18,50	22,5	18,5	2	348
TT 20x17	20	17	1,5	235	TT 22,5x19,50	22,5	19,5	1,5	267
TT 20x17,40	20	17,4	1,3	205	TT 22,5x20,10	22,5	20,1	1,2	217
TT 20x17,60	20	17,6	1,2	192	TT 22,5x20,50	22,5	20,5	1	184
TT 20x18	20	18	1	161	TT 22,7x16,50	22,7	16,5	3,1	514
TT 20,1x16,10	20,1	16,1	2	308	TT 23x12	23	12	5,5	815
TT 20,1x17,50	20,1	17,5	1,3	205	TT 23x12,50	23	12,5	5,25	790
TT 20,3x18,70	20,3	18,7	0,8	132	TT 23x16	23	16	3,5	579
TT 20,5x18,10	20,5	18,1	1,2	198	TT 23x17	23	17	3	509
TT 20,7x10,50	20,7	10,5	5,1	675	TT 23x18	23	18	2,5	435
TT 21x8,50	21	8,5	6,25	782	TT 23x19	23	19	2	356
TT 21x14	21	14	3,5	520	TT 23x19,50	23	19,5	1,75	315
TT 21x14,3	21	14,3	3,35	502	TT 23x20	23	20	1,5	273
TT 21x17	21	17	2	322	TT 23x20,60	23	20,6	1,2	222
TT 21x18	21	18	1,5	249	TT 23x20,80	23	20,8	1,1	204
TT 21x19	21	19	1	170	TT 23x21	23	21	1	186
TT 21,25x16,85	21,25	16,85	2,2	355	TT 23,5x10,80	23,5	10,8	6,35	923
TT 21,6x17	21,6	17	2,3	376	TT 23,5x20,50	23,5	20,5	1,5	281
TT 21,85x5,70	21,85	5,7	8,075	944	TT 23,5x21,50	23,5	21,5	1	192
TT 22x10	22	10	6	814	TT 23,8x20,20	23,8	20,2	1,8	336
TT 22x10,20	22	10,2	5,9	800	TT 24x14	24	14	5	805

\* Unless otherwise indicated, profiles are made of EN AW-6060T6 alloy

\* All dimensions are expressed in mm

Via Newton, n.12  
20016 Pero (Milano - Italy)  
Tel. +39 02 3535955 r.a. Fax. +39 02 3539929  
E-Mail: info@omar-alluminio.it

Cataloghi Online: [www.omar-alluminio.it](http://www.omar-alluminio.it)  
[www.omar-alluminio.com](http://www.omar-alluminio.com)

CUSTOM ALUMINUM PROFILES / STANDARD / SPECIAL / AND FOR:  
ELECTRONICS / LED / PHOTOVOLTAIC / ROBOTIC AUTOMATION / PNEUMATICS / AUTOMOTIVE



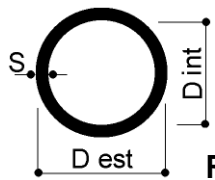

For more sizes of round aluminum tubes visit the site:

[www.tubi-alluminio.it](http://www.tubi-alluminio.it)

## ROUND TUBES

TUBI TONDI	D est	D int	S	GR/MT	TUBI TONDI	D est	D int	S	GR/MT
TT 24x14,20	24	14,2	4,9	794	TT 25x22,80	25	22,8	1,1	223
TT 24x15	24	15	4,5	744	TT 25x23	25	23	1	203
TT 24x16	24	16	4	679	TT 25,2x20	25,2	20	2,6	~500
TT 24x18	24	18	3	534	TT 25,2x20,30	25,2	20,3	2,45	473
TT 24x19	24	19	2,5	455	TT 25,2x23,20	25,2	23,2	1	205
TT 24x20	24	20	2	373	TT 25,4x12,20	25,4	12,2	6,6	1052
TT 24x20,20	24	20,2	1,9	356	TT 25,4x19,86	25,4	19,86	2,77	532
TT 24x20,80	24	20,8	1,6	317	TT 25,4x21,20	25,4	21,2	2,1	414
TT 24x21	24	21	1,5	286	TT 25,4x22,40	25,4	22,4	1,5	304
TT 24x21,50	24	21,5	1,25	240	TT 25,5x12,50	25,5	12,5	6,5	1044
TT 24x22	24	22	1	195	TT 25,5x14,50	25,5	14,5	5,5	932
TT 24,3x18,50	24,3	18,5	2,9	526	TT 25,5x22	25,5	22	1,75	352
TT 24,5x9,50	24,5	9,5	7,5	1081	TT 25,5x23,3	25,5	23,3	1,1	223
TT 24,5x22,20	24,5	22,2	1,15	227	TT 26x15	26	15	5,5	956
TT 24,6x20	24,6	20	2,3	435	TT 26x16	26	16	5	890
TT 24,7x21,70	24,7	21,7	1,5	294	TT 26x17	26	17	4,5	821
TT 24,8x19	24,8	19	2,9	537	TT 26x17,30	26	17,3	4,35	799
TT 24,8x20,80	24,8	20,8	2	387	TT 26x17,80	26	17,8	4,1	762
TT 25x5	25	5	10	1275	TT 26x18	26	18	4	746
TT 25x5,50	25	5,5	9,75	1261	TT 26x20	26	20	3	585
TT 25x7	25	7	9	1221	TT 26x21	26	21	2,5	498
TT 25x8,20	25	8,2	8,4	1183	TT 26x22	26	22	2	407
TT 25x8,50	25	8,5	8,25	1172	TT 26x22,40	26	22,4	1,8	370
TT 25x10	25	10	7,5	1113	TT 26x23	26	23	1,5	312
TT 25x10,30	25	10,3	7,35	1099	TT 26x23,20	26	23,2	1,4	295
TT 25x11	25	11	7	1069	TT 26x23,50	26	23,5	1,25	262
TT 25x12	25	12	6,5	1020	TT 26x23,60	26	23,6	1,2	250
TT 25x12,50	25	12,5	6,25	994	TT 26x24	26	24	1	213
TT 25x13	25	13	6	966	TT 26,15x16,35	26,15	16,35	4,9	883
TT 25x14	25	14	5,5	909	TT 26,4x21,70	26,4	21,7	2,35	478
TT 25x15	25	15	5	848	TT 26,45x19,65	26,45	19,65	3,4	665
TT 25x15,20	25	15,2	4,9	835	TT 26,5x12,40	26,5	12,4	7,05	1163
TT 25x16	25	16	4,5	782	TT 26,5x19,50	26,5	19,5	3,5	680
TT 25x16,50	25	16,5	4,25	748	TT 26,5x21,60	26,5	21,6	2,45	502
TT 25x17	25	17	4	713	TT 26,7x22,70	26,7	22,7	2	419
TT 25x18	25	18	3,5	638	TT 26,8x21	26,8	21	2,9	589
TT 25x18,50	25	18,5	3,25	600	TT 27x17	27	17	5	1003
TT 25x19	25	19	3	560	TT 27x19	27	19	4	780
TT 25x19,80	25	19,8	2,6	318	TT 27x20,60	27	20,6	3,2	646
TT 25x20	25	20	2,5	477	TT 27x21	27	21	3	610
TT 25x21	25	21	2	390	TT 27x21,40	27	21,4	2,8	575
TT 25x22	25	22	1,5	300	TT 27x23	27	23	2	424
TT 25x22,20	25	22,2	1,4	278	TT 27x24	27	24	1,5	324
TT 25x22,40	25	22,4	1,3	260	TT 27x25	27	25	1	220
TT 25x22,50	25	22,5	1,25	254	TT 27,5x24	27,5	24	1,75	382
TT 25x22,60	25	22,6	1,2	242	TT 27,5x25,10	27,5	25,1	1,2	268
TT 25x22,70	25	22,7	1,15	232	TT 27,6x20,60	27,6	20,6	3,5	715

\* Unless otherwise indicated, profiles are made of EN AW-6060T6 alloy

\* All dimensions are expressed in mm

Via Newton, n.12  
20016 Pero (Milano - Italy)  
Tel. +39 02 3535955 r.a. Fax. +39 02 3539929  
E-Mail: info@omar-alluminio.it

Cataloghi Online: [www.tubi-alluminio.it](http://www.tubi-alluminio.it)  
[www.omar-alluminio.com](http://www.omar-alluminio.com)

CUSTOM ALUMINUM PROFILES / STANDARD / SPECIAL / AND FOR:  
ELECTRONICS / LED / PHOTOVOLTAIC / ROBOTIC AUTOMATION / PNEUMATICS / AUTOMOTIVE



CONTINUOUS UPDATE

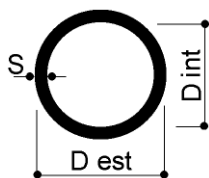

For more sizes of round aluminum tubes visit the site:

[www.tubi-alluminio.it](http://www.tubi-alluminio.it)

## ROUND TUBES

TUBI TONDI	D est	D int	S	GR/MT	TUBI TONDI	D est	D int	S	GR/MT
TT 27,6x21	27,6	21	3,3	680	TT 29,8x27,40	29,8	27,4	1,2	291
TT 27,6x23,2	27,6	23,2	2,2	473	TT 30x8	30	8	11	1772
TT 27,6x23,6	27,6	23,6	2	435	TT 30x10,50	30	10,5	9,75	1674
TT 27,9x23	27,9	23	2,45	529	TT 30x13,20	30	13,2	8,4	1538
TT 28x15	28	15	6,5	1186	TT 30x13,50	30	13,5	8,25	1522
TT 28x16	28	16	6	1119	TT 30x13,80	30	13,8	8,1	1505
TT 28x18	28	18	5	970	TT 30x14	30	14	8	1490
TT 28x19	28	19	4,5	897	TT 30x15	30	15	7,5	1431
TT 28x20	28	20	4	816	TT 30x16	30	16	7	1366
TT 28x21	28	21	3,5	727	TT 30x16,40	30	16,4	6,8	1337
TT 28x21,50	28	21,5	3,25	682	TT 30x17	30	17	6,5	1296
TT 28x21,70	28	21,7	3,15	664	TT 30x17,50	30	17,5	6,25	1222
TT 28x22	28	22	3	636	TT 30x18	30	18	6	1221
TT 28x23	28	23	2,5	541	TT 30x19	30	19	5,5	1142
TT 28x23,50	28	23,5	2,25	491	TT 30x20	30	20	5	1060
TT 28x24	28	24	2	441	TT 30x21	30	21	4,5	973
TT 28x24,20	28	24,2	1,9	419	TT 30x22	30	22	4	882
TT 28x24,50	28	24,5	1,75	389	TT 30x23	30	23	3,5	787
TT 28x24,60	28	24,6	1,7	379	TT 30x24	30	24	3	687
TT 28x24,80	28	24,8	1,6	356	TT 30x24,40	30	24,4	2,8	646
TT 28x25	28	25	1,5	338	TT 30x24,80	30	24,8	2,6	605
TT 28x25,60	28	25,6	1,2	270	TT 30x25	30	25	2,5	583
TT 28x26	28	26	1	229	TT 30x25,1	30	25,1	2,45	572
TT 28,3x25,50	28,3	25,5	1,4	319	TT 30x26	30	26	2	475
TT 28,5x18,50	28,5	18,5	5	996	TT 30x26,20	30	26,2	1,9	452
TT 28,5x19,50	28,5	19,5	4,5	910	TT 30x26,60	30	26,6	1,7	408
TT 28,5x20	28,5	20	4,25	874	TT 30x26,80	30	26,8	1,6	386
TT 28,5x21,50	28,5	21,5	3,5	742	TT 30x27	30	27	1,5	363
TT 28,5x25	28,5	25	1,75	397	TT 30x27,20	30	27,2	1,4	340
TT 28,5x25,70	28,5	25,7	1,4	322	TT 30x27,40	30	27,4	1,3	316
TT 28,5x26,30	28,5	26,3	1,1	255	TT 30x27,60	30	27,6	1,2	293
TT 28,6x20,60	28,6	20,6	4	834	TT 30x28	30	28	1	246
TT 28,6x23	28,6	23	2,8	612	TT 30,4x14,70	30,4	14,7	7,85	1501
TT 28,7x25,7	28,7	25,7	1,5	346	TT 30,4x15,50	30,4	15,5	7,45	1453
TT 28,9x26,9	28,9	26,9	1	236	TT 30,4x17,40	30,4	17,4	6,5	1323
TT 29x16	29	16	6,5	1240	TT 30,4x28	30,4	28	1,2	299
TT 29x17	29	17	6	1170	TT 30,4x28,20	30,4	28,2	1,1	273
TT 29x19,5	29	19,5	4,75	977	TT 30,6x28	30,6	28	1,3	323
TT 29x20	29	20	4,5	935	TT 30,7x28	30,7	28	1,35	336
TT 29x22	29	22	3,5	756	TT 31x19	31	19	6	1272
TT 29x23	29	23	3	662	TT 31x21	31	21	5	1102
TT 29x24	29	24	2,5	562	TT 31x22	31	22	4,5	1007
TT 29x25	29	25	2	458	TT 31x24	31	24	3,5	817
TT 29x25,40	29	25,4	1,8	416	TT 31x25	31	25	3	713
TT 29x26	29	26	1,5	550	TT 31x28	31	28	1,5	~380
TT 29x27	29	27	1	237	TT 31x29	31	29	1	253
TT 29,1x19,70	29,1	19,7	4,7	973	TT 31,6x26	31,6	26	2,8	684

\* Unless otherwise indicated, profiles are made of EN AW-6060T6 alloy

\* All dimensions are expressed in mm

Via Newton, n.12  
20016 Pero (Milano - Italy)  
Tel. +39 02 3535955 r.a. Fax. +39 02 3539929  
E-Mail: info@omar-alluminio.it

Cataloghi Online: [www.omar-alluminio.it](http://www.omar-alluminio.it)  
[www.omar-alluminio.com](http://www.omar-alluminio.com)

CUSTOM ALUMINUM PROFILES / STANDARD / SPECIAL / AND FOR:  
ELECTRONICS / LED / PHOTOVOLTAIC / ROBOTIC AUTOMATION / PNEUMATICS / AUTOMOTIVE



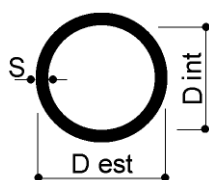

For more sizes of round aluminum tubes visit the site:

[www.tubi-alluminio.it](http://www.tubi-alluminio.it)

## ROUND TUBES

TUBI TONDI	D est	D int	S	GR/MT	TUBI TONDI	D est	D int	S	GR/MT
TT 31,7x27,30	31,7	27,3	2,2	550	TT 33x30	33	30	1,5	401
TT 31,7x28,70	31,7	28,7	1,5	384	TT 33x31	33	31	1	272
TT 31,8x22	31,8	22	4,9	1117	TT 33,2x24	33,2	24	4,6	1116
TT 32x8	32	8	12	2036	TT 33,3x26,30	33,3	26,3	3,5	885
TT 32x12	32	12	10	1866	TT 33,5x16	33,5	16	8,75	1837
TT 32x14	32	14	9	1755	TT 33,5x20,50	33,5	20,5	6,5	1488
TT 32x15	32	15	8,5	1693	TT 33,5x29	33,5	29	2,25	596
TT 32x17	32	17	7,5	1559	TT 33,5x29,50	33,5	29,5	2	534
TT 32x20	32	20	6	1323	TT 33,5x30	33,5	30	1,75	471
TT 32x21	32	21	5,5	1236	TT 34x14,70	34	14,7	9,65	1993
TT 32x22	32	22	5	1145	TT 34x15,50	34	15,5	9,25	1942
TT 32x22,80	32	22,8	4,6	1069	TT 34x16	34	16	9	1908
TT 32x23	32	23	4,5	1049	TT 34x16,3	34	16,3	8,85	1888
TT 32x24	32	24	4	950	TT 34x18,50	34	18,5	7,75	1726
TT 32x24,40	32	24,4	3,8	907	TT 34x19	34	19	7,5	1686
TT 32x25	32	25	3,5	846	TT 34x20	34	20	7	~1400
TT 32x25,50	32	25,5	3,25	792	TT 34x20,40	34	20,4	6,8	1357
TT 32x26	32	26	3	738	TT 34x21	34	21	6,5	1516
TT 32x26,40	32	26,4	2,8	693	TT 34x22	34	22	6	1425
TT 32x27	32	27	2,5	581	TT 34x24	34	24	5	1230
TT 32x27,50	32	27,5	2,25	567	TT 34x25	34	25	4,5	1126
TT 32x28	32	28	2	509	TT 34x26	34	26	4	1018
TT 32x29	32	29	1,5	388	TT 34x26,5	34	26,5	3,75	962
TT 32x29,6	32	29,6	1,2	313	TT 34x27	34	27	3,5	906
TT 32x29,80	32	29,8	1,1	466	TT 34x28	34	28	3	789
TT 32x30	32	30	1	263	TT 34x29	34	29	2,5	668
TT 32,1x26,10	32,1	26,1	3	740	TT 34x30	34	30	2	543
TT 32,1x29,10	32,1	29,1	1,5	389	TT 34x30,20	34	30,2	1,9	516
TT 32,15x26,15	32,15	26,15	3	740	TT 34x31	34	31	1,5	413
TT 32,4x26	32,4	26	3,2	793	TT 34x32	34	32	1	280
TT 32,5x16,70	32,5	16,7	7,9	1648	TT 34,4x18,50	34,4	18,5	7,95	1784
TT 32,6x24,80	32,6	24,8	3,9	949	TT 34,4x20	34,4	20	7,2	1661
TT 33x8,40	33	8,4	12,3	2159	TT 34,4x20,50	34,4	20,5	6,95	1618
TT 33x12	33	12	10,5	2004	TT 34,4x26	34,4	26	4,2	1076
TT 33x17,50	33	17,5	7,75	1659	TT 34,4x32,20	34,4	32,2	1,1	310
TT 33x20	33	20	6,5	1461	TT 34,5x14,20	34,5	14,2	10,15	2144
TT 33x20,50	33	20,5	6,25	1418	TT 34,5x21	34,5	21	6,75	1588
TT 33x23	33	23	5	1188	TT 34,5x31	34,5	31	1,75	486
TT 33x24	33	24	4,5	1088	TT 34,65x26,15	34,65	26,15	4,25	1094
TT 33x25	33	25	4	983	TT 34,68x26,28	34,68	26,28	4,2	1084
TT 33x25,50	33	25,5	3,75	930	TT 34,7x25,50	34,7	25,5	4,6	1174
TT 33x25,60	33	25,6	3,7	931	TT 34,85x26,15	34,85	26,15	4,35	1125
TT 33x25,70	33	25,7	3,65	908	TT 35x10	35	10	12,5	2386
TT 33x26	33	26	3,5	876	TT 35x12,20	35	12,2	11,4	2285
TT 33x27	33	27	3	763	TT 35x15	35	15	10	2121
TT 33x28	33	28	2,5	647	TT 35x18,50	35	18,5	8,25	1871
TT 33x29	33	29	2	526	TT 35x19	35	19	8	1831

\* Unless otherwise indicated, profiles are made of EN AW-6060T6 alloy

\* All dimensions are expressed in mm

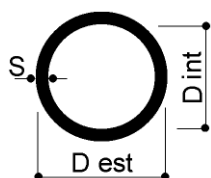

For more sizes of round aluminum tubes visit the site:

[www.tubi-alluminio.it](http://www.tubi-alluminio.it)

## ROUND TUBES

TUBI TONDI	D est	D int	S	GR/MT	TUBI TONDI	D est	D int	S	GR/MT
TT 35x22	35	22	6,5	1572	TT 36,15x33,75	36,15	33,75	1,2	356
TT 35x24,50	35	24,5	5,25	1325	TT 36,2x26	36,2	26	5,1	1345
TT 35x25	35	25	5	1273	TT 36,2x26,60	36,2	26,6	4,8	1278
TT 35x25,30	35	25,3	4,85	1242	TT 36,4x26	36,4	26	5,2	1373
TT 35x25,60	35	25,6	4,7	1212	TT 36,55x26,15	36,55	26,15	5,2	1383
TT 35x26	35	26	4,5	1164	TT 36,6x26,60	36,6	26,6	5	1340
TT 35x27	35	27	4	1052	TT 37x26	37	26	5,5	1470
TT 35x27,60	35	27,6	3,7	981	TT 37x27	37	27	5	1357
TT 35x28	35	28	3,5	935	TT 37x29	37	29	4	1120
TT 35x29	35	29	3	813	TT 37x30	37	30	3,5	994
TT 35x30	35	30	2,5	689	TT 37x31	37	31	3	865
TT 35x30,60	35	30,6	2,2	612	TT 37x32	37	32	2,5	732
TT 35x31	35	31	2	560	TT 37x33	37	33	2	594
TT 35x31,10	35	31,1	1,95	549	TT 37x33,80	37	33,8	1,6	481
TT 35x31,40	35	31,4	1,8	577	TT 37x34	37	34	1,5	452
TT 35x32	35	32	1,5	426	TT 37x34,50	37	34,5	1,25	379
TT 35x32,20	35	32,2	1,4	400	TT 37x35	37	35	1	305
TT 35x32,60	35	32,6	1,2	344	TT 37,1x29,10	37,1	29,1	4	1123
TT 35x33	35	33	1	289	TT 37,2x26	37,2	26	5,6	1501
TT 35,05x25,85	35,05	25,85	4,6	1188	TT 38x21	38	21	8,5	2126
TT 35,05x26,15	35,05	26,15	4,45	1155	TT 38x22,50	38	22,5	7,75	1937
TT 35,2x26	35,2	26	4,6	1193	TT 38x23	38	23	7,5	1940
TT 35,35x25,85	35,35	25,85	4,75	1232	TT 38x23,80	38	23,8	7,1	1861
TT 35,5x27,20	35,5	27,2	4,15	1104	TT 38x24	38	24	7	1841
TT 35,6x26	35,6	26	4,8	1254	TT 38x25	38	25	6,5	1736
TT 35,65x26,15	35,65	26,15	4,75	1243	TT 38x28	38	28	5	1399
TT 35,8x26	35,8	26	4,9	1284	TT 38x29	38	29	4,5	~1270
TT 35,95x26,15	35,95	26,15	4,9	1291	TT 38x30	38	30	4	1156
TT 36x12	36	12	12	2442	TT 38x31	38	31	3,5	1024
TT 36x14	36	14	11	2331	TT 38x32	38	32	3	890
TT 36x16	36	16	10	2204	TT 38x32,80	38	32,8	2,6	781
TT 36x17	36	17	9,5	2134	TT 38x33	38	33	2,5	752
TT 36x18	36	18	9	2060	TT 38x34	38	34	2	610
TT 36x20	36	20	8	1899	TT 38x35	38	35	1,5	464
TT 36x21	36	21	7,5	1813	TT 38x35,40	38	35,4	1,3	404
TT 36x22	36	22	7	1720	TT 38x36	38	36	1	313
TT 36x23	36	23	6,5	1626	TT 38,5x17	38,5	17	10,75	2530
TT 36x26	36	26	5	1314	TT 38,5x19	38,5	19	9,75	2379
TT 36x28	36	28	4	1085	TT 38,5x20	38,5	20	9,25	2294
TT 36x29	36	29	3,5	965	TT 38,5x24	38,5	24	7,25	1921
TT 36x30	36	30	3	840	TT 38,5x25	38,5	25	6,75	1817
TT 36x31	36	31	2,5	711	TT 38,5x26,50	38,5	26,5	6	1654
TT 36x32	36	32	2	577	TT 38,6x35,60	38,6	35,6	1,5	472
TT 36x32,50	36	32,5	1,75	508	TT 38,85x28,65	38,85	28,65	5,1	1459
TT 36x33	36	33	1,5	438	TT 39x29	39	29	5	1440
TT 36x34	36	34	1	297	TT 39x31	39	31	4	1186
TT 36,05x26,15	36,05	26,15	4,95	1306	TT 39x32	39	32	3,5	1054

\* Unless otherwise indicated, profiles are made of EN AW-6060T6 alloy

\* All dimensions are expressed in mm

Via Newton, n.12  
20016 Pero (Milano - Italy)  
Tel. +39 02 3535955 r.a. Fax. +39 02 3539929  
E-Mail: info@omar-alluminio.it

Cataloghi Online: [www.omar-alluminio.it](http://www.omar-alluminio.it)  
[www.omar-alluminio.com](http://www.omar-alluminio.com)

CUSTOM ALUMINUM PROFILES / STANDARD / SPECIAL / AND FOR:  
ELECTRONICS / LED / PHOTOVOLTAIC / ROBOTIC AUTOMATION / PNEUMATICS / AUTOMOTIVE



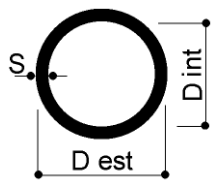

For more sizes of round aluminum tubes  
visit the site:

[www.tubi-alluminio.it](http://www.tubi-alluminio.it)

## ROUND TUBES

TUBI TONDI	D est	D int	S	GR/MT	TUBI TONDI	D est	D int	S	GR/MT
TT 39x33	39	33	3	916	TT 41x33	41	33	4	1256
TT 39x34	39	34	2,5	774	TT 41x35	41	35	3	967
TT 39x36	39	36	1,5	477	TT 41x38	41	38	1,5	503
TT 39,5x17	39,5	17	11,25	2696	TT 41x38,60	41	38,6	1,2	405
TT 39,5x20	39,5	20	9,75	2460	TT 41,03x32,63	41,03	32,63	4,2	1309
TT 39,5x21	39,5	21	9,25	2371	TT 41,2x32,50	41,2	32,5	4,35	1358
TT 39,5x22,40	39,5	22,4	8,55	2243	TT 41,6x32,50	41,6	32,5	4,55	1429
TT 39,5x24,20	39,5	24,2	7,65	2113	TT 41,7x32,50	41,7	32,5	4,6	1447
TT 39,5x32,50	39,5	32,5	3,5	1069	TT 41,8x35,80	41,8	35,8	3	988
TT 39,9x36,90	39,9	36,9	1,5	486	TT 42x21	42	21	10,5	2805
TT 40x10	40	10	15	3180	TT 42x22	42	22	10	2714
TT 40x11	40	11	14,5	2067	TT 42x23	42	23	9,5	2619
TT 40x12,50	40	12,5	13,75	3062	TT 42x26	42	26	8	2306
TT 40x15	40	15	12,5	2914	TT 42x26,50	42	26,5	7,75	2252
TT 40x16	40	16	12	2849	TT 42x26,6	42	26,6	7,7	2240
TT 40x16,50	40	16,5	11,75	3021	TT 42x27	42	27	7,5	2194
TT 40x18	40	18	11	2706	TT 42x27,30	42	27,3	7,35	2160
TT 40x20	40	20	10	2543	TT 42x30	42	30	6	1831
TT 40x21	40	21	9,5	2458	TT 42x32	42	32	5	1568
TT 40x22,50	40	22,5	8,75	2319	TT 42x34	42	34	4	1289
TT 40x24	40	24	8	1256	TT 42x34,40	42	34,4	3,8	1231
TT 40x25	40	25	7,5	2067	TT 42x35	42	35	3,5	1142
TT 40x27	40	27	6,5	1846	TT 42x36	42	36	3	992
TT 40x28	40	28	6	1729	TT 42x37	42	37	2,5	837
TT 40x30	40	30	5	1484	TT 42x38	42	38	2	678
TT 40x32	40	32	4	1221	TT 42x39	42	39	1,5	515
TT 40x33	40	33	3,5	1083	TT 42x40	42	40	1	347
TT 40x34	40	34	3	942	TT 42,1x32,50	42,1	32,5	4,8	1519
TT 40x35	40	35	2,5	795	TT 42,2x32,50	42,2	32,5	4,85	1537
TT 40x36	40	36	2	645	TT 42,3x38	42,3	38	2,15	732
TT 40x36,40	40	36,4	1,8	583	TT 42,4x38,40	42,4	38,4	2	686
TT 40x37	40	37	1,5	490	TT 42,4x40,40	42,4	40,4	1	351
TT 40x37,10	40	37,1	1,45	474	TT 42,5x32,50	42,5	32,5	5	1590
TT 40x37,50	40	37,5	1,25	410	TT 43x22,50	43	22,5	10,25	2846
TT 40x37,60	40	37,6	1,2	394	TT 43x27	43	27	8	2376
TT 40x38	40	38	1	331	TT 43x28	43	28	7,5	2254
TT 40,1x32,10	40,1	32,1	4	1226	TT 43x30	43	30	6,5	2012
TT 40,1x36,50	40,1	36,5	1,8	586	TT 43x30,50	43	30,5	6,25	1948
TT 40,2x38,20	40,2	38,2	1	332	TT 43x33	43	33	5	1611
TT 40,4x32,40	40,4	32,4	4	1235	TT 43x35	43	35	4	1323
TT 40,6x38,50	40,6	38,5	1,05	352	TT 43x37	43	37	3	1018
TT 40,7x36,70	40,7	36,7	2	656	TT 43x39	43	39	2	705
TT 41x14,70	41	14,7	13,15	3106	TT 43x39,80	43	39,8	1,6	561
TT 41x26	41	26	7,5	2131	TT 43x40	43	40	1,5	530
TT 41x30	41	30	5,5	1658	TT 43x41	43	41	1	356
TT 41x31	41	31	5	1527	TT 43,1x32,50	43,1	32,5	5,3	1699
TT 41x32	41	32	4,5	1393	TT 43,7x32,50	43,7	32,5	5,6	1810

\* Unless otherwise indicated, profiles are made of EN AW-6060T6 alloy

\* All dimensions are expressed in mm



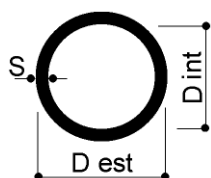

For more sizes of round aluminum tubes visit the site:

[www.tubi-alluminio.it](http://www.tubi-alluminio.it)

## ROUND TUBES

TUBI TONDI	D est	D int	S	GR/MT	TUBI TONDI	D est	D int	S	GR/MT
TT 44x34	44	34	5	1654	TT 46x40	46	40	3	1097
TT 44x36	44	36	4	1357	TT 46x41	46	41	2,5	923
TT 44x37,40	44	37,4	3,3	1139	TT 46x41,40	46	41,4	2,3	850
TT 44x38	44	38	3	1043	TT 46x42	46	42	2	747
TT 44x40	44	40	2	713	TT 46x42,50	46	42,5	1,75	657
TT 44x41	44	41	1,5	541	TT 46x43	46	43	1,5	566
TT 44x41,60	44	41,6	1,2	435	TT 46,2x40,40	46,2	40,4	2,9	1068
TT 44x42	44	42	1	365	TT 46,2x43,20	46,2	43,2	1,5	569
TT 44,8x40	44,8	40	2,4	861	TT 46,5x38,50	46,5	38,5	4	1442
TT 45x15	45	15	15	3817	TT 46,6x44	46,6	44	1,3	500
TT 45x19	45	19	13	3529	TT 47x35	47	35	6	2086
TT 45x20	45	20	12,5	3444	TT 47x37	47	37	5	1781
TT 45x20,5	45	20,5	12,25	3402	TT 47x39	47	39	4	1459
TT 45x22	45	22	11,5	3266	TT 47x40	47	40	3,5	1291
TT 45x25	45	25	10	2967	TT 47x44	47	44	1,5	579
TT 45x26,10	45	26,1	9,45	2848	TT 47x44,80	47	44,8	1,1	426
TT 45x27	45	27	9	2748	TT 47,1x43,50	47,1	43,5	1,8	691
TT 45x28	45	28	8,5	2630	TT 47,3x43,10	47,3	43,1	2,1	1535
TT 45x29	45	29	8	2511	TT 47,38x38,98	47,38	38,98	4,2	1535
TT 45x30	45	30	7,5	2384	TT 47,58x38,98	47,58	38,98	4,3	1580
TT 45x31	45	31	7	2254	TT 47,8x38,90	47,8	38,9	4,45	1636
TT 45x33	45	33	6	1985	TT 47,9x38,90	47,9	38,9	4,5	1656
TT 45x34	45	34	5,5	1842	TT 48x22	48	22	13	3859
TT 45x35	45	35	5	1696	TT 48x25	48	25	11,5	3559
TT 45x37	45	37	4	1391	TT 48x28	48	28	10	3223
TT 45x37,30	45	37,3	3,85	1344	TT 48x28,50	48	28,5	9,75	3163
TT 45x38	45	38	3,5	1231	TT 48x28,60	48	28,6	9,7	3150
TT 45x39	45	39	3	1069	TT 48x29,30	48	29,3	9,35	3064
TT 45x40	45	40	2,5	901	TT 48x31	48	31	8,5	2848
TT 45x41	45	41	2	729	TT 48x38	48	38	5	1823
TT 45x41,50	45	41,5	1,75	643	TT 48x40	48	40	4	1493
TT 45x42	45	42	1,5	554	TT 48x41	48	41	3,5	1321
TT 45x42,60	45	42,6	1,2	446	TT 48x42	48	42	3	1145
TT 45x43	45	43	1	373	TT 48x42,50	48	42,5	2,75	~1050
TT 45,1x24,90	45,1	24,9	10,1	2998	TT 48x43	48	43	2,5	965
TT 45,1x40	45,1	40	2,55	918	TT 48x44	48	44	2	780
TT 45,4x39,40	45,4	39,4	3	1079	TT 48x44,40	48	44,4	1,8	705
TT 46x20,50	46	20,5	12,75	3596	TT 48x45	48	45	1,5	591
TT 46x24	46	24	11	3267	TT 48x45,60	48	45,6	1,2	475
TT 46x27	46	27	9,5	2941	TT 48x46	48	46	1	399
TT 46x27,50	46	27,5	9,25	2882	TT 48,1x38,90	48,1	38,9	4,6	1698
TT 46x28	46	28	9	2824	TT 48,2x38,90	48,2	38,9	4,65	1718
TT 46x29	46	29	8,5	2702	TT 48,2x40,20	48,2	40,2	4	1500
TT 46x31	46	31	7,5	2449	TT 48,25x40,25	48,25	40,25	4	1501
TT 46x34	46	34	6	2036	TT 48,3x38,70	48,3	38,7	4,8	2000
TT 46x38	46	38	4	1425	TT 48,3x40,30	48,3	40,3	4	1502
TT 46x39	46	39	3,5	1262	TT 48,3x40,70	48,3	40,7	3,8	1434

\* Unless otherwise indicated, profiles are made of EN AW-6060T6 alloy

\* All dimensions are expressed in mm

Via Newton, n.12  
20016 Pero (Milano - Italy)  
Tel. +39 02 3535955 r.a. Fax. +39 02 3539929  
E-Mail: info@omar-alluminio.it

Cataloghi Online: [www.omar-alluminio.it](http://www.omar-alluminio.it)  
[www.omat-alluminio.com](http://www.omat-alluminio.com)

CUSTOM ALUMINUM PROFILES / STANDARD / SPECIAL / AND FOR:  
ELECTRONICS / LED / PHOTOVOLTAIC / ROBOTIC AUTOMATION / PNEUMATICS / AUTOMOTIVE



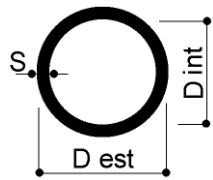

For more sizes of round aluminum tubes visit the site:

[www.tubi-alluminio.it](http://www.tubi-alluminio.it)

## ROUND TUBES

TUBI TONDI	D est	D int	S	GR/MT	TUBI TONDI	D est	D int	S	GR/MT
TT 48,3x41,10	48,3	41,1	3,6	1363	TT 50x44,20	50	44,2	2,9	1139
TT 48,3x41,90	48,3	41,9	3,2	1224	TT 50x44,30	50	44,3	2,85	1139
TT 48,3x42,30	48,3	42,3	3	1153	TT 50x45	50	45	2,5	1007
TT 48,3x43,10	48,3	43,1	2,6	1011	TT 50x45,60	50	45,6	2,2	892
TT 48,3x43,30	48,3	43,3	2,5	971	TT 50x46	50	46	2	814
TT 48,3x43,80	48,3	43,8	2,25	879	TT 50x46,80	50	46,8	1,6	666
TT 48,3x44,30	48,3	44,3	2	783	TT 50x47	50	47	1,5	617
TT 48,4x39,46	48,4	39,46	4,47	1672	TT 50x47,20	50	47,2	1,4	577
TT 48,5x38,90	48,5	38,9	4,8	1778	TT 50x47,40	50	47,4	1,3	537
TT 48,6x38,90	48,6	38,9	4,85	1800	TT 50x47,60	50	47,6	1,2	497
TT 48,7x38,90	48,7	38,9	4,9	1820	TT 50x47,80	50	47,8	1,1	456
TT 48,8x39,10	48,8	39,1	4,85	1800	TT 50x48	50	48	1	415
TT 49x33	49	33	8	2782	TT 50,1x38,90	50,1	38,9	5,6	2114
TT 49x34	49	34	7,5	2641	TT 50,1x40,10	50,1	40,1	5	2014
TT 49x39	49	39	5	1865	TT 50,1x46,90	50,1	46,9	1,6	659
TT 49x42	49	42	3,5	1350	TT 50,2x46,60	50,2	46,6	1,8	739
TT 49x43	49	43	3	1171	TT 50,4x25	50,4	25	12,7	4059
TT 49x44	49	44	2,5	986	TT 50,4x26,50	50,4	26,5	11,95	3897
TT 49x45	49	45	2	797	TT 50,4x32	50,4	32	9,2	3215
TT 49x46	49	46	1,5	1865	TT 50,4x33	50,4	33	8,7	3077
TT 49x46,40	49	46,4	1,3	526	TT 50,4x34	50,4	34	8,2	2935
TT 49x47	49	47	1	407	TT 50,4x44,40	50,4	44,4	3	1209
TT 49,1x38,90	49,1	38,9	5,1	1903	TT 50,5x23,50	50,5	23,5	13,5	4237
TT 49,3x38,90	49,3	38,9	5,2	1945	TT 50,5x26	50,5	26	12,25	3972
TT 49,4x46,40	49,4	46,4	1,5	607	TT 50,5x27,50	50,5	27,5	11,5	3802
TT 49,7x38,90	49,7	38,9	5,4	2029	TT 50,5x28	50,5	28	11,25	3745
TT 49,7x44,70	49,7	44,7	2,5	1001	TT 50,5x29	50,5	29	10,75	3628
TT 50x20	50	20	15	4451	TT 50,5x30,50	50,5	30,5	10	3435
TT 50x23	50	23	13,5	4180	TT 50,5x31,10	50,5	31,1	9,7	3356
TT 50x25	50	25	12,5	3974	TT 50,5x32	50,5	32	9,25	3237
TT 50x27	50	27	11,5	3753	TT 50,5x33	50,5	33	8,75	3099
TT 50x27,50	50	27,5	11,25	3698	TT 50,5x33,50	50,5	33,5	8,5	3027
TT 50x28	50	28	11	3639	TT 50,5x45,20	50,5	45,2	2,65	1076
TT 50x28,50	50	28,5	10,75	3577	TT 50,6x46,40	50,5	46,4	2,05	864
TT 50x29	50	29	10,5	3518	TT 50,6x46,60	50,6	46,6	2	824
TT 50x30	50	30	10	3393	TT 50,8x44,40	50,8	44,4	3,2	1292
TT 50x31	50	31	9,5	3264	TT 50,8x45,30	50,8	45,3	2,75	1121
TT 50x33	50	33	8,5	2992	TT 50,8x46,20	50,8	46,2	2,3	946
TT 50x34	50	34	8	2849	TT 50,8x47,60	50,8	47,6	1,6	670
TT 50x35	50	35	7,5	2702	TT 50,8x47,80	50,8	47,8	1,5	642
TT 50x37	50	37	6,5	2397	TT 51x30	51	30	10,5	3607
TT 50x38	50	38	6	2238	TT 51x40	51	40	5,5	2122
TT 50x38,20	50	38,2	5,9	2209	TT 51x44	51	44	3,5	1410
TT 50x40	50	40	5	1909	TT 51x44,6	51	44,6	3,2	1299
TT 50x42	50	42	4	1560	TT 51x45	51	45	3	1200
TT 50x43	50	43	3,5	1380	TT 51x46	51	46	2,5	1195
TT 50x44	50	44	3	1196	TT 51x47	51	47	2	831

\* Unless otherwise indicated, profiles are made of EN AW-6060T6 alloy

\* All dimensions are expressed in mm

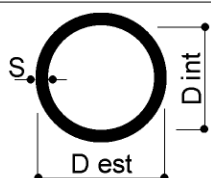

For more sizes of round aluminum tubes  
visit the site:

[www.tubi-alluminio.it](http://www.tubi-alluminio.it)

## ROUND TUBES

TUBI TONDI	D est	D int	S	GR/MT	TUBI TONDI	D est	D int	S	GR/MT
TT 51x48	51	48	1,5	629	TT 55x47	55	47	4	1730
TT 51x49	51	49	1	424	TT 55x48	55	48	3,5	1529
TT 51,5x43	51,5	43	4,25	1703	TT 55x49	55	49	3	1322
TT 52x30	52	30	11	3824	TT 55x50	55	50	2,5	1113
TT 52x34	52	34	9	3281	TT 55x50,20	55	50,2	2,4	1072
TT 52x40	52	40	6	2341	TT 55x50,4	55	50,4	2,3	1028
TT 52x41	52	41	5,5	2168	TT 55x51	55	51	2	899
TT 52x42	52	42	5	1993	TT 55x51,84	55	51,84	1,58	716
TT 52x44	52	44	4	1628	TT 55x52	55	52	1,5	680
TT 52x45	52	45	3,5	1439	TT 55x53	55	53	1	458
TT 52x46	52	46	3	1250	TT 55,2x50,40	55,2	50,4	2,4	1074
TT 52x48	52	48	2	848	TT 55,2x51,20	55,2	51,2	2	~900
TT 52x49	52	49	1,5	642	TT 55,4x49,90	55,4	49,9	2,75	1230
TT 52x49,8	52	49,8	1,1	470	TT 55,50x38,20	55,5	38,2	8,65	~3800
TT 53x37	53	37	8	~3400	TT 55,8x45	55,8	45	5,4	2306
TT 53x48	53	48	2,5	1076	TT 56x25	56	25	15,5	5324
TT 53x49	53	49	2	865	TT 56x30	56	30	13	4739
TT 53x50	53	50	1,5	655	TT 56x30,90	56	30,9	12,55	4624
TT 53x51	53	51	1	440	TT 56x31	56	31	12,5	4611
TT 53,6x50	53,6	50	1,8	792	TT 56x36	56	36	10	3902
TT 53,9x50,82	53,9	50,82	1,54	686	TT 56x37	56	37	9,5	3748
TT 54x25	54	25	14,5	4929	TT 56x40	56	40	8	3256
TT 54x30	54	30	12	~4600	TT 56x52	56	52	2	916
TT 54x37	54	37	8,5	3279	TT 56x53	56	53	1,5	693
TT 54x38	54	38	8	3124	TT 56x54	56	54	1	466
TT 54x38,20	54	38,2	7,9	~3100	TT 56,3x40	56,3	40	8,15	1299
TT 54x46	54	46	4	1696	TT 56,3x53,70	56,3	53,7	1,3	608
TT 54x48	54	48	3	1299	TT 57x30	57	30	13,5	4980
TT 54x48,40	54	48,4	2,8	1216	TT 57x31	57	31	13	4852
TT 54x49	54	49	2,5	1091	TT 57x51	57	51	3	1373
TT 54x50	54	50	2	882	TT 57x52	57	52	2,5	1155
TT 54x51	54	51	1,5	668	TT 57x53	57	53	2	933
TT 54x52	54	52	1	449	TT 57x54	57	54	1,5	706
TT 55x20	55	20	17,5	5564	TT 57x55	57	55	1	474
TT 55x23	55	23	16	5293	TT 58x38	58	38	10	4080
TT 55x25	55	25	15	5087	TT 58x44,5	58	44,5	6,75	2962
TT 55x30	55	30	12,5	4506	TT 58x48	58	48	5	2257
TT 55x32	55	32	11,5	4241	TT 58x49,30	58	49,3	4,35	1980
TT 55x35	55	35	10	3815	TT 58x50	58	50	4	1905
TT 55x36	55	36	9,5	3667	TT 58x53	58	53	2,5	1176
TT 55x37	55	37	9	~3500	TT 58x53,20	58	53,2	2,4	1131
TT 55x38	55	38	8,5	3353	TT 58x54	58	54	2	950
TT 55x39	55	39	8	3188	TT 58x55	58	55	1,5	719
TT 55x40	55	40	7,5	3020	TT 58x56	58	56	1	483
TT 55x43	55	43	6	2494	TT 58,5x45	58,5	45	6,75	2962
TT 55x44	55	44	5,5	2309	TT 58,5x55	58,5	55	1,75	842
TT 55x45	55	45	5	2119	TT 59x49	59	49	5	2289

\* Unless otherwise indicated, profiles are made of EN AW-6060T6 alloy

\* All dimensions are expressed in mm

Via Newton, n.12  
20016 Pero (Milano - Italy)  
Tel. +39 02 353955 r.a. Fax. +39 02 3539929  
E-Mail: info@omar-alluminio.it

Cataloghi Online: [www.omar-alluminio.it](http://www.omar-alluminio.it)  
[www.omat-alluminio.com](http://www.omat-alluminio.com)

CUSTOM ALUMINUM PROFILES / STANDARD / SPECIAL / AND FOR:  
ELECTRONICS / LED / PHOTOVOLTAIC / ROBOTIC AUTOMATION / PNEUMATICS / AUTOMOTIVE



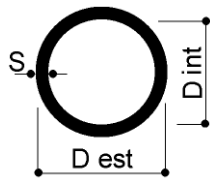

For more sizes of round aluminum tubes visit the site:

[www.tubi-alluminio.it](http://www.tubi-alluminio.it)

## ROUND TUBES

TUBI TONDI	D est	D int	S	GR/MT	TUBI TONDI	D est	D int	S	GR/MT
TT 59x52,40	59	52,4	3,3	1559	TT 61x54,40	61	54,4	3,3	1615
TT 59x55	59	55	2	967	TT 61x57	61	57	2	1001
TT 59x56	59	56	1,5	731	TT 61x58	61	58	1,5	757
TT 59,3x55,80	59,3	55,8	1,75	854	TT 61x59	61	59	1	509
TT 59,5x57,50	59,5	57,5	1	496	TT 62x37	62	37	12,5	~5300
TT 59,7x56,80	59,7	56,8	1,45	718	TT 62x37,50	62	37,5	12,25	5169
TT 60x20	60	20	20	6782	TT 62x42	62	42	10	4410
TT 60x25	60	25	17,5	6305	TT 62x43	62	43	9,5	4231
TT 60x29	60	29	15,5	5851	TT 62x48	62	48	7	3264
TT 60x30	60	30	15	5725	TT 62x50	62	50	6	2851
TT 60x31	60	31	14,5	5597	TT 62x51,70	62	51,7	5,15	2483
TT 60x32	60	32	14	5462	TT 62x56,80	62	56,8	2,6	1309
TT 60x34,50	60	34,5	12,75	5145	TT 62x58	62	58	2	1015
TT 60x35	60	35	12,5	5035	TT 62x58,20	62	58,2	1,9	969
TT 60x36	60	36	12	4886	TT 62x59	62	59	1,5	770
TT 60x38	60	38	11	4570	TT 62x59,40	62	59,4	1,3	670
TT 60x40	60	40	10	4239	TT 62x60	62	60	1	2417
TT 60x41,30	60	41,3	9,35	~3900	TT 62,2x51,60	62,2	51,6	5,3	2558
TT 60x44	60	44	8	3527	TT 62,3x48,3	62,3	48,3	7	1020
TT 60x45	60	45	7,5	3338	TT 62,6x51,70	62,6	51,7	5,45	2641
TT 60x46	60	46	7	3147	TT 63x43	63	43	10	4496
TT 60x48	60	48	6	2748	TT 63x48	63	48	7,5	3530
TT 60x49	60	49	5,5	2543	TT 63x51	63	51	6	2901
TT 60x49,10	60	49,1	5,45	2522	TT 63x52,50	63	52,5	5,25	2570
TT 60x50	60	50	5	2333	TT 63x53	63	53	5	2460
TT 60x51	60	51	4,5	2117	TT 63x54	63	54	4,5	2233
TT 60x52	60	52	4	1900	TT 63x57	63	57	3	1526
TT 60x52,50	60	52,5	3,75	1787	TT 63x58	63	58	2,5	1282
TT 60x53	60	53	3,5	1677	TT 63x59	63	59	2	1034
TT 60x54	60	54	3	1450	TT 63x59,8	63	59,8	1,6	833
TT 60x55	60	55	2,5	1219	TT 63x60	63	60	1,5	782
TT 60x56	60	56	2	984	TT 63,1x51,10	63,1	51,1	6	2905
TT 60x57	60	57	1,5	744	TT 63,1x59,10	63,1	59,1	2	1034
TT 60x57,10	60	57,1	1,45	720	TT 63,5x53,50	63,5	53,5	5	2481
TT 60x57,40	60	57,4	1,3	647	TT 63,5x60,5	63,5	60,5	1,5	789
TT 60x57,60	60	57,6	1,2	598	TT 63,7x57,70	63,7	57,7	3	2933
TT 60x58	60	58	1	500	TT 64x28	64	28	18	7021
TT 60,2x19,80	60,2	19,8	20,2	6854	TT 64x41	64	41	11,5	5121
TT 60,2x24,90	60,2	24,9	17,65	6370	TT 64x57	64	57	3,5	1796
TT 60,3x54,30	60,3	54,3	3	1458	TT 64x59	64	59	2,5	1303
TT 60,5x55,50	60,5	55,5	2,5	1229	TT 64x60	64	60	2	1052
TT 60,8x51,60	60,8	51,6	4,6	2193	TT 64x61	64	61	1,5	795
TT 61x31	61	31	15	5851	TT 64x62	64	62	1	534
TT 61x31,50	61	31,5	14,75	5787	TT 64,6x31	64,6	31	16,8	~6900
TT 61x37	61	37	12	4986	TT 65x30	65	30	17,5	7074
TT 61x37,90	61	37,9	11,55	4841	TT 65x35	65	35	15	6361
TT 61x39	61	39	11	4663	TT 65x39	65	39	13	5731

\* Unless otherwise indicated, profiles are made of EN AW-6060T6 alloy

\* All dimensions are expressed in mm



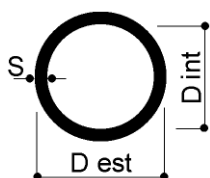

For more sizes of round aluminum tubes visit the site:

[www.tubi-alluminio.it](http://www.tubi-alluminio.it)

## ROUND TUBES

TUBI TONDI	D est	D int	S	GR/MT	TUBI TONDI	D est	D int	S	GR/MT
TT 65x40	65	40	12,5	5564	TT 69,5x43	69,5	43	13,25	6322
TT 65x45	65	45	10	4663	TT 69,5x66,10	69,5	66,1	1,7	978
TT 65x50	65	50	7,5	3656	TT 70x25	70	25	22,5	9066
TT 65x54	65	54	5,5	2776	TT 70x30	70	30	20	8478
TT 65x55	65	55	5	2554	TT 70x32	70	32	19	8219
TT 65x57	65	57	4	2069	TT 70x35	70	35	17,5	7793
TT 65x58,80	65	58,8	3,1	1628	TT 70x36	70	36	17	7638
TT 65x59,80	65	59,8	2,6	1375	TT 70x38	70	38	16	7329
TT 65x60	65	60	2,5	1325	TT 70x40	70	40	15	6994
TT 65x61	65	61	2	1069	TT 70x41	70	41	14,5	7128
TT 65x62	65	62	1,5	808	TT 70x43	70	43	13,5	6470
TT 65x62,20	65	62,2	1,4	755	TT 70x45	70	45	12,5	6097
TT 65x62,40	65	62,4	1,3	705	TT 70x46	70	46	12	6003
TT 65x63	65	63	1	543	TT 70x50	70	50	10	5089
TT 65,3x57,2	65,3	57,2	4,05	2103	TT 70x52	70	52	9	4654
TT 65,3x60,50	65,3	60,5	2,4	1280	TT 70x53	70	53	8,5	~4430
TT 65,4x61,40	65,4	61,4	2	1076	TT 70x54	70	54	8	4207
TT 65,5x51,50	65,5	51,5	7	3472	TT 70x55	70	55	7,5	3974
TT 66x22	66	22	22	8211	TT 70x58	70	58	6	3255
TT 66x23	66	23	21,5	8115	TT 70x60	70	60	5	2758
TT 66x60	66	60	3	1603	TT 70x62	70	62	4	2239
TT 66x61,60	66	61,6	2,2	1190	TT 70x62,40	70	62,4	3,8	2134
TT 66x62	66	62	2	1086	TT 70x63	70	63	3,5	1974
TT 66x63	66	63	1,5	821	TT 70x64	70	64	3	1705
TT 66,5x63	66,5	63	1,75	961	TT 70x65	70	65	2,5	1431
TT 66,5x63,50	66,5	63,5	1,5	826	TT 70x66	70	66	2	1154
TT 66,7x47,70	66,7	47,7	9,5	4607	TT 70x67	70	67	1,5	872
TT 67x45	67	45	11	5225	TT 70x67,50	70	67,5	1,25	729
TT 67x50	67	50	8,5	4218	TT 70x67,60	70	67,6	1,2	699
TT 67x63	67	63	2	1102	TT 70x67,80	70	67,8	1,1	643
TT 67x64	67	64	1,5	833	TT 70x68	70	68	1	586
TT 67x64,50	67	64,5	1,25	697	TT 70,2x45	70,2	45	12,6	6156
TT 68x44	68	44	12	5697	TT 70,2x54,80	70,2	54,8	7,7	4082
TT 68x45	68	45	11,5	5509	TT 70,5x65	70,5	65	2,75	1580
TT 68x50	68	50	9	4502	TT 70,5x65,50	70,5	65,5	2,5	1442
TT 68x56	68	56	6	3155	TT 70,8x67,80	70,8	67,8	1,5	883
TT 68x60	68	60	4	2171	TT 71x54	71	54	8,5	4506
TT 68x63	68	63	2,5	1390	TT 71x61	71	61	5	2797
TT 68x64	68	64	2	1120	TT 71x62	71	62	4,5	2537
TT 68x65	68	65	1,5	846	TT 71x67	71	67	2	1170
TT 69x50	69	50	9,5	4793	TT 72x32	72	32	20	8822
TT 69x61	69	61	4	2205	TT 72x40	72	40	16	7600
TT 69x62	69	62	3,5	1944	TT 72x52	72	52	10	5260
TT 69x65	69	65	2	1137	TT 72x60	72	60	6	3359
TT 69x66	69	66	1,5	859	TT 72,5x68,50	72,5	68,5	2	1196
TT 69,5x33,50	69,5	33,5	18	7863	TT 73x23	73	23	25	10176
TT 69,5x42	69,5	42	13,75	6502	TT 73x28	73	28	22,5	9635

\* Unless otherwise indicated, profiles are made of EN AW-6060T6 alloy

\* All dimensions are expressed in mm

Via Newton, n.12  
20016 Pero (Milano - Italy)  
Tel. +39 02 3535955 r.a. Fax. +39 02 3539929  
E-Mail: info@omar-alluminio.it

Cataloghi Online: [www.omar-alluminio.it](http://www.omar-alluminio.it)  
[www.omar-alluminio.com](http://www.omar-alluminio.com)

CUSTOM ALUMINUM PROFILES / STANDARD / SPECIAL / AND FOR:  
ELECTRONICS / LED / PHOTOVOLTAIC / ROBOTIC AUTOMATION / PNEUMATICS / AUTOMOTIVE



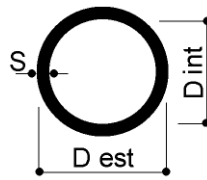

For more sizes of round aluminum tubes visit the site:

[www.tubi-alluminio.it](http://www.tubi-alluminio.it)

## ROUND TUBES

TUBI TONDI	D est	D int	S	GR/MT	TUBI TONDI	D est	D int	S	GR/MT
TT 73x35	73	35	19	8698	TT 76x39	76	39	18,5	8679
TT 73x40	73	40	16,5	7905	TT 76x43	76	43	16,5	8326
TT 73x45	73	45	14	7003	TT 76x44	76	44	16	8138
TT 73x50	73	50	11,5	6000	TT 76x57	76	57	9,5	5359
TT 73x55	73	55	9	4887	TT 76x60	76	60	8	4614
TT 73x61	73	61	6	3410	TT 76x66	76	66	5	3217
TT 73x63,20	73	63,2	4,9	2830	TT 76x68	76	68	4	2443
TT 73x68	73	68	2,5	1495	TT 76x69	76	69	3,5	2152
TT 73x70	73	70	1,5	910	TT 76x70	76	70	3	1858
TT 73,03x62,71	73,03	62,71	5,16	2971	TT 76x71	76	71	2,5	1558
TT 73,5x66	73,5	66	3,75	2218	TT 76x72	76	72	2	1255
TT 74x23	74	23	25,5	10476	TT 76x73	76	73	1,5	948
TT 74x24	74	24	25	10390	TT 76,2x71,20	76,2	71,2	2,5	1562
TT 74x28	74	28	23	9945	TT 76,2x72,20	76,2	72,2	2	1259
TT 74x29	74	29	22,5	9828	TT 76,2x74,20	76,2	74,2	1	638
TT 74x34,50	74	34,5	19,75	~8600	TT 77x57	77	57	10	5683
TT 74x39	74	39	17,5	8386	TT 77x68,20	77	68,2	4,4	2710
TT 74x50	74	50	12	6307	TT 77x70	77	70	3,5	2181
TT 74x71	74	71	1,5	920	TT 77x74	77	74	1,5	960
TT 74x71,40	74	71,4	1,3	802	TT 77,5x55,50	77,5	55,5	11	6205
TT 74,2x70,20	74,2	70,2	2	~1300	TT 77,5x72,80	77,5	72,8	2,35	1499
TT 74,5x28,50	74,5	28,5	23	10047	TT 78x60	78	60	9	5268
TT 74,5x33,50	74,5	33,5	20,5	9385	TT 78x66	78	66	6	3664
TT 74,7x59,70	74,7	59,7	7,5	4273	TT 78x71,5	78	71,5	3,25	2061
TT 75x31	75	31	22	9888	TT 78x75	78	75	1,5	973
TT 75x33	75	33	21	9326	TT 78x76	78	76	1	652
TT 75x35	75	35	20	9330	TT 79x75	79	75	2	1304
TT 75x40	75	40	17,5	8535	TT 79x76	79	76	1,5	986
TT 75x45	75	45	15	7630	TT 79,4x75	79,4	75	2,2	1441
TT 75x50	75	50	12,5	6626	TT 79,7x76,80	79,7	76,8	1,45	962
TT 75x53	75	53	11	~5800	TT 80x25	80	25	27,5	12247
TT 75x55	75	55	10	5511	TT 80x30	80	30	25	11655
TT 75x60	75	60	7,5	4294	TT 80x33	80	33	23,5	11262
TT 75x61	75	61	7	4038	TT 80x34	80	34	23	11120
TT 75x62	75	62	6,5	3777	TT 80x35	80	35	22,5	10968
TT 75x65	75	65	5	2969	TT 80x38	80	38	21	10507
TT 75x67	75	67	4	2409	TT 80x40	80	40	20	10174
TT 75x68	75	68	3,5	2166	TT 80x45	80	45	17,5	9277
TT 75x69	75	69	3	1830	TT 80x46	80	46	17	9085
TT 75x69,20	75	69,2	2,9	1774	TT 80x48	80	48	16	8681
TT 75x70	75	70	2,5	1537	TT 80x49	80	49	15,5	8481
TT 75x71	75	71	2	1238	TT 80x50	80	50	15	8266
TT 75x72	75	72	1,5	935	TT 80x55	80	55	12,5	7158
TT 75x73	75	73	1	627	TT 80x60	80	60	10	5938
TT 75,2x44,80	75,2	44,8	15,2	7736	TT 80x62	80	62	9	~5400
TT 75,2x54,80	75,2	54,8	10,2	5624	TT 80x63	80	63	8,5	5155
TT 75,2x72,60	75,2	72,6	1,3	814	TT 80x64	80	64	8	4886

\* Unless otherwise indicated, profiles are made of EN AW-6060T6 alloy

\* All dimensions are expressed in mm

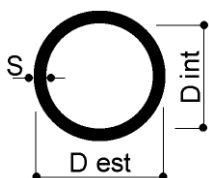

For more sizes of round aluminum tubes  
visit the site:

[www.tubi-alluminio.it](http://www.tubi-alluminio.it)

## ROUND TUBES

TUBI TONDI	D est	D int	S	GR/MT	TUBI TONDI	D est	D int	S	GR/MT
TT 80x65	80	65	7,5	4610	TT 84x68	84	68	8	5157
TT 80x65,80	80	65,8	7,1	4390	TT 84x70	84	70	7	4572
TT 80x67	80	67	6,5	4052	TT 84x78	84	78	3	2389
TT 80x68	80	68	6	3766	TT 84x80	84	80	2	1391
TT 80x70	80	70	5	3181	TT 84,6x55	84,6	55	14,8	8758
TT 80x72	80	72	4	2577	TT 85x40	85	40	22,5	~12500
TT 80x73	80	73	3,5	2274	TT 85x45	85	45	20	11027
TT 80x74	80	74	3	1959	TT 85x50	85	50	17,5	10017
TT 80x75	80	75	2,5	1643	TT 85x55	85	55	15	~8700
TT 80x75,20	80	75,2	2,4	1579	TT 85x60	85	60	12,5	7687
TT 80x76	80	76	2	1323	TT 85x64	85	64	10,5	6633
TT 80x77	80	77	1,5	998	TT 85x65	85	65	10	6359
TT 80x77,10	80	77,1	1,45	967	TT 85x70,60	85	70,6	7,2	4752
TT 80x77,20	80	77,2	1,4	933	TT 85x75	85	75	5	3391
TT 80x77,30	80	77,3	1,35	901	TT 85x79	85	79	3	2086
TT 80x77,40	80	77,4	1,3	867	TT 85x80	85	80	2,5	1749
TT 80x77,60	80	77,6	1,2	802	TT 85x81	85	81	2	1407
TT 80x78	80	78	1	670	TT 85x82	85	82	1,5	1062
TT 80,1x75,30	80,1	75,3	2,4	1582	TT 86x45	86	45	20,5	11387
TT 80,4x77	80,4	77	1,7	1135	TT 86x74	86	74	6	4069
TT 81x46	81	46	17,5	9423	TT 86x81,50	86	81,5	2,25	1598
TT 81x55	81	55	13	7500	TT 87x62	87	62	12,5	~8900
TT 81x60	81	60	10,5	6276	TT 87x80	87	80	3,5	2482
TT 81x61	81	61	10	6018	TT 87x81	87	81	3	2138
TT 81x65	81	65	8	~4800	TT 87x82,20	87	82,2	2,4	1722
TT 81x71	81	71	5	3220	TT 87x83	87	83	2	1442
TT 81,2x76,20	81,2	76,2	2,5	1669	TT 87x84	87	84	1,5	1088
TT 82x54	82	54	14	8075	TT 87,2x81,50	87,2	81,5	2,85	2038
TT 82x62	82	62	10	6104	TT 87,5x63,50	87,5	63,5	12	7680
TT 82x66	82	66	8	5018	TT 88,9x84,90	88,9	84,9	2	1474
TT 82x70	82	70	6	3868	TT 89x58,50	89	58,5	15,25	9539
TT 82x73	82	73	4,5	2957	TT 89x60	89	60	14,5	~9000
TT 82x76	82	76	3	2010	TT 89x63,60	89	63,6	12,7	~7900
TT 82x79	82	79	1,5	1024	TT 89x79	89	79	5	3563
TT 82,5x72,80	82,5	72,8	4,85	3197	TT 89x80,90	89	80,9	4,05	2919
TT 82,5x77	82,5	77	2,75	1857	TT 89x82	89	82	3,5	2538
TT 83x28	83	28	27,5	12943	TT 89x83	89	83	3	2188
TT 83x40	83	40	21,5	11213	TT 89x84	89	84	2,5	1834
TT 83x45	83	45	19	~12300	TT 89x85	89	85	2	1476
TT 83x70	83	70	6,5	4218	TT 89x86,30	89	86,3	1,35	1004
TT 83x73	83	73	5	3307	TT 89x86,60	89	86,6	1,2	894
TT 83x75	83	75	4	2682	TT 89x86,80	89	86,8	1,1	820
TT 83x76	83	76	3,5	2360	TT 89x87	89	87	1	746
TT 83x77	83	77	3	2035	TT 89,2x80	89,2	80	4,6	3302
TT 83,5x76,50	83,5	76,5	3,5	2376	TT 90x40	90	40	25	13784
TT 83,5x77,50	83,5	77,5	3	2047	TT 90x45	90	45	22,5	12881
TT 84x60	84	60	12	7329	TT 90x50	90	50	20	11869

\* Unless otherwise indicated, profiles are made of EN AW-6060T6 alloy

\* All dimensions are expressed in mm

Via Newton, n.12  
20016 Pero (Milano - Italy)  
Tel. +39 02 3539555 r.a. Fax. +39 02 3539929  
E-Mail: info@omar-alluminio.it

Cataloghi Online: [www.omar-alluminio.it](http://www.omar-alluminio.it)

[www.omar-alluminio.com](http://www.omar-alluminio.com)

CUSTOM ALUMINUM PROFILES / STANDARD / SPECIAL / AND FOR:

ELECTRONICS / LED / PHOTOVOLTAIC / ROBOTIC AUTOMATION / PNEUMATICS / AUTOMOTIVE



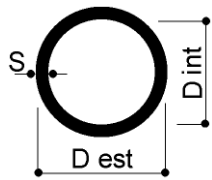

For more sizes of round aluminum tubes  
visit the site:

[www.tubi-alluminio.it](http://www.tubi-alluminio.it)

## ROUND TUBES

TUBI TONDI	D est	D int	S	GR/MT	TUBI TONDI	D est	D int	S	GR/MT
TT 90x55	90	55	17,5	10760	TT 95x56	95	56	19,5	12488
TT 90x58,60	90	58,6	15,7	9920	TT 95x65	95	65	15	10179
TT 90x60	90	60	15	9573	TT 95x70	95	70	12,5	8745
TT 90x63	90	63	13,5	8756	TT 95x75	95	75	10	~6800
TT 90x65	90	65	12,5	8216	TT 95x76	95	76	9,5	6025
TT 90x68	90	68	11	7371	TT 95x81	95	81	7	5224
TT 90x70	90	70	10	6786	TT 95x83	95	83	6	4547
TT 90x74	90	74	8	5565	TT 95x85	95	85	5	3815
TT 90x75	90	75	7,5	5250	TT 95x87	95	87	4	3088
TT 90x78	90	78	6	4275	TT 95x90	95	90	2,5	1963
TT 90x80	90	80	5	3604	TT 95x91	95	91	2	1577
TT 90x82	90	82	4	2916	TT 95x92	95	92	1,5	1195
TT 90x83	90	83	3,5	2568	TT 95x92,60	95	92,6	1,2	954
TT 90x84	90	84	3	2213	TT 95,5x90	95,5	90	2,75	2163
TT 90x85	90	85	2,5	1856	TT 95,5x93,10	95,5	93,1	1,2	959
TT 90x86	90	86	2	1493	TT 96x50	96	50	23	14235
TT 90x86,80	90	86,8	1,6	1200	TT 96x90	96	90	3	2367
TT 90x87	90	87	1,5	1125	TT 96,5x93,70	96,5	93,7	1,4	1129
TT 90,1x85,30	90,1	85,3	2,4	1905	TT 96,85x93,45	96,85	93,45	1,7	1371
TT 90,15x39,75	90,15	39,75	25,2	13862	TT 97x90	97	90	3,5	2774
TT 90,2x49,80	90,2	49,8	20,2	11985	TT 97x91	97	91	3	2392
TT 90,3x39,70	90,3	39,7	25,3	13948	TT 98x64	98	64	17	11674
TT 91x70	91	70	10,5	7166	TT 98x95,10	98	95,1	1,45	1188
TT 91x87	91	87	2	1510	TT 98x96	98	96	1	822
TT 91x88	91	88	1,5	1138	TT 98,4x93,80	98,4	93,8	2,3	1874
TT 91x88,40	91	88,4	1,3	989	TT 99x52	99	52	23,5	15046
TT 91x88,60	91	88,6	1,2	915	TT 100x30	100	30	35	19287
TT 91,2x86,40	91,2	86,4	2,4	1807	TT 100x40	100	40	30	17813
TT 91,5x78,50	91,5	78,5	6,5	4687	TT 100x45	100	45	27,5	16912
TT 92x55	92	55	18,5	~13100	TT 100x50	100	50	25	15896
TT 92x70	92	70	11	~7900	TT 100x55	100	55	22,5	14780
TT 92x76	92	76	8	5700	TT 100x60	100	60	20	13565
TT 92x79	92	79	6,5	4714	TT 100x65	100	65	17,5	12240
TT 92x81,60	92	81,6	5,2	3829	TT 100x68	100	68	16	11400
TT 92x86	92	86	3	2265	TT 100x70	100	70	15	10809
TT 93x28	93	28	32,5	16674	TT 100x71	100	71	14,5	10516
TT 93x35	93	35	29	15739	TT 100x75	100	75	12,5	9307
TT 93x40	93	40	26,5	14944	TT 100x76	100	76	12	8957
TT 93x42	93	42	25,5	14791	TT 100x78	100	78	11	8300
TT 93x45	93	45	24	14043	TT 100x80	100	80	10	7634
TT 93x55	93	55	19	11923	TT 100x84	100	84	8	6243
TT 93x73	93	73	10	7038	TT 100x85	100	85	7,5	5885
TT 94x80	94	80	7	5163	TT 100x86	100	86	7	5522
TT 94x81	94	81	6,5	4825	TT 100x88	100	88	6	4782
TT 94x90	94	90	2	1560	TT 100x90	100	90	5	4029
TT 94x91,30	94	91,3	1,35	1061	TT 100x92	100	92	4	3257
TT 94,5x81,50	94,5	81,5	6,5	4852	TT 100x92,50	100	92,5	3,75	3060

\* Unless otherwise indicated, profiles are made of EN AW-6060T6 alloy

\* All dimensions are expressed in mm



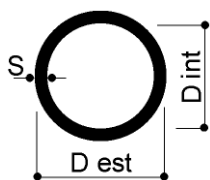

For more sizes of round aluminum tubes  
visit the site:

[www.tubi-alluminio.it](http://www.tubi-alluminio.it)

## ROUND TUBES

TUBI TONDI	D est	D int	S	GR/MT	TUBI TONDI	D est	D int	S	GR/MT
TT 100x94	100	94	3	2467	TT 105x100	105	100	2,5	2174
TT 100x94,40	100	94,4	2,8	2309	TT 105x101	105	101	2	1747
TT 100x95	100	95	2,5	2068	TT 106x70	106	70	18	13435
TT 100x95,4	100	95,4	2,3	1906	TT 106x100	106	100	3	2650
TT 100x96	100	96	2	1663	TT 107x82	107	82	12,5	~10400
TT 100x97	100	97	1,5	1253	TT 107x90	107	90	8,5	7098
TT 100x97,20	100	97,2	1,4	1170	TT 107x92	107	92	7,5	6329
TT 100x97,40	100	97,4	1,3	1088	TT 107x94	107	94	6,5	5541
TT 100x97,60	100	97,6	1,2	1007	TT 107x97	107	97	5	4325
TT 100,5x96,50	100,5	96,5	2	1671	TT 107x102	107	102	2,5	3072
TT 100,5x98,14	100,5	98,14	1,18	994	TT 108x80	108	80	14	11163
TT 100,7x98,30	100,7	98,3	1,2	1012	TT 108x85	108	85	11,5	~9900
TT 101x64	101	64	18,5	12000	TT 108x95,40	108	95,4	6,3	5435
TT 101x75	101	75	13	9699	TT 108x100	108	100	4	3527
TT 101x77	101	77	12	9059	TT 108x102	108	102	3	2672
TT 101x80	101	80	10,5	8057	TT 108x103	108	103	2,5	2237
TT 101x90	101	90	5,5	4455	TT 108x105,40	108	105,4	1,3	1177
TT 101x97	101	97	2	1679	TT 108x105,80	108	105,8	1,1	997
TT 101,5x97,50	101,5	97,5	2	1690	TT 108x106	108	106	1	907
TT 101,6x50,80	101,6	50,8	25,4	~21000	TT 109x102	109	102	3,5	3132
TT 101,6x63,50	101,6	63,5	19,05	~15600	TT 110x40	110	40	35	22260
TT 101,6x96,60	101,6	96,6	2,5	2101	TT 110x45	110	45	32,5	21365
TT 102x35	102	35	33,5	~25400	TT 110x50	110	50	30	20358
TT 102x77	102	77	12,5	9485	TT 110x60	110	60	25	18025
TT 102x86	102	86	8	6376	TT 110x65	110	65	22,5	16690
TT 102x90	102	90	6	4887	TT 110x70	110	70	20	15268
TT 102x95	102	95	3,5	2924	TT 110x71	110	71	19,5	14969
TT 102x96	102	96	3	2519	TT 110x75	110	75	17,5	13775
TT 102x97	102	97	2,5	2118	TT 110x80	110	80	15	12081
TT 102x99,60	102	99,6	1,2	1026	TT 110x85	110	85	12,5	10335
TT 102x100	102	100	1	856	TT 110x90	110	90	10	8479
TT 103x94	103	94	4,5	3758	TT 110x92	110	92	9	7711
TT 103x99	103	99	2	1713	TT 110x94	110	94	8	6920
TT 103,5x101,10	103,5	101,1	1,2	1042	TT 110x95	110	95	7,5	6521
TT 104x99,20	104	99,2	2,4	2068	TT 110x98	110	98	6	5292
TT 104x100	104	100	2	1730	TT 110x100	110	100	5	4451
TT 104x101	104	101	1,5	1303	TT 110x102	110	102	4	3590
TT 104,5x94,50	104,5	94,5	5	4220	TT 110x104	110	104	3	2723
TT 105x45	105	45	30	19080	TT 110x104,80	110	104,8	2,6	2367
TT 105x55	105	55	25	~24350	TT 110x105	110	105	2,5	2279
TT 105x62	105	62	21,5	15220	TT 110x106	110	106	2	1831
TT 105x75	105	75	15	11451	TT 110x106,20	110	106,2	1,9	1741
TT 105x79	105	79	13	~9900	TT 110x107	110	107	1,5	1380
TT 105x80	105	80	12,5	~9500	TT 110x107,60	110	107,6	1,2	1107
TT 105x85	105	85	10	~7600	TT 110,1x104,10	110,1	104,1	3	2863
TT 105x90	105	90	7,5	6201	TT 110,5x77	110,5	77	16,75	13316
TT 105x95	105	95	5	4239	TT 111x72	111	72	19,5	15130

\* Unless otherwise indicated, profiles are made of EN AW-6060T6 alloy

\* All dimensions are expressed in mm

Via Newton, n.12  
20016 Pero (Milano - Italy)  
Tel. +39 02 3535955 r.a. Fax. +39 02 3539929  
E-Mail: info@omar-alluminio.it

Cataloghi Online: [www.omar-alluminio.it](http://www.omar-alluminio.it)  
[www.omar-alluminio.com](http://www.omar-alluminio.com)  
CUSTOM ALUMINUM PROFILES / STANDARD / SPECIAL / AND FOR:  
ELECTRONICS / LED / PHOTOVOLTAIC / ROBOTIC AUTOMATION / PNEUMATICS / AUTOMOTIVE



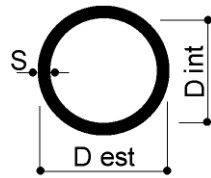

For more sizes of round aluminum tubes visit the site:

[www.tubi-alluminio.it](http://www.tubi-alluminio.it)

## ROUND TUBES

TUBI TONDI	D est	D int	S	GR/MT	TUBI TONDI	D est	D int	S	GR/MT
TT 111x99	111	99	6	5343	TT 120x65	120	65	27,5	~21500
TT 111x106,20	111	106,2	2,4	2205	TT 120x70	120	70	25	20211
TT 111,3x107,70	111,3	107,7	1,8	1671	TT 120x75	120	75	22,5	18600
TT 111,7x106,70	111,7	106,7	2,5	2317	TT 120x80	120	80	20	16956
TT 112x80	112	80	16	13025	TT 120x84	120	84	18	15574
TT 112x88	112	88	12	10179	TT 120x85	120	85	17,5	15210
TT 112x105	112	105	3,5	3220	TT 120x88	120	88	16	14200
TT 112,5x99,50	112,5	99,5	6,5	5843	TT 120x90	120	90	15	13360
TT 113x89	113	89	12	10269	TT 120x95	120	95	12,5	13360
TT 113x100	113	100	6,5	5873	TT 120x96	120	96	12	10993
TT 114x82	114	82	16	13297	TT 120x100	120	100	10	9330
TT 114x105,50	114	105,5	4,25	3956	TT 120x104	120	104	8	7596
TT 114x108,50	114	108,5	2,75	2594	TT 120x105	120	105	7,5	7157
TT 114x109	114	109	2,5	2364	TT 120x106	120	106	7	6709
TT 114x111,20	114	111,2	1,4	1337	TT 120x108	120	108	6	5802
TT 114,3x63,50	114,3	63,5	25,4	~23400	TT 120x109,5	120	109,5	5,25	5109
TT 114,3x108,30	114,3	108,3	3	2762	TT 120x110	120	110	5	4875
TT 114,3x110,70	114,3	110,7	1,8	1717	TT 120x112	120	112	4	3934
TT 115x70	115	70	22,5	17649	TT 120x114	120	114	3	2976
TT 115x75	115	75	20	16116	TT 120x115	120	115	2,5	2492
TT 115x85	115	85	15	12765	TT 120x116	120	116	2	2001
TT 115x88	115	88	13,5	11623	TT 120x117	120	117	1,5	1507
TT 115x90	115	90	12,5	10865	TT 120,15x69,75	120,15	69,75	25,2	20261
TT 115x91	115	91	12	~10200	TT 120,5x114,5	120,5	114,5	3	3003
TT 115x95	115	95	10	8907	TT 121x106	121	106	7,5	7220
TT 115x100	115	100	7,5	6837	TT 121,9x95,20	121,9	95,2	13,35	12286
TT 115x105	115	105	5	4580	TT 122x84	122	84	19	16600
TT 115x106	115	106	4,5	4218	TT 123x100	123	100	11,5	10873
TT 115x108	115	108	3,5	3310	TT 123,6x120	123,6	120	1,8	1897
TT 115x109	115	109	3	823	TT 123,8x120	123,8	120	1,9	1964
TT 115x110	115	110	2,5	2384	TT 124x72	124	72	26	21613
TT 115x112	115	112	1,5	1443	TT 124x83	124	83	20,5	17992
TT 116x74	116	74	21	16921	TT 124x90	124	90	17	15425
TT 116x110	116	110	3	2875	TT 124x121	124	121	1,5	1565
TT 116x112	116	112	2	1914	TT 125x40	125	40	42,5	~36000
TT 117x111	117	111	3	2827	TT 125x42	125	42	41,5	~35200
TT 117x114	117	114	1,5	1469	TT 125x75	125	75	25	21206
TT 118x65	118	65	26,5	~26000	TT 125x80	125	80	22,5	~20000
TT 118x75	118	75	21,5	~21000	TT 125x85	125	85	20	17813
TT 118x115,60	118	115,6	1,2	1188	TT 125x90	125	90	17,5	15953
TT 118,4x78,40	118,4	78,4	20	16685	TT 125x93	125	93	16	14800
TT 119x85	119	85	17	14701	TT 125x95	125	95	15	~14300
TT 119x99	119	99	10	9247	TT 125x100	125	100	12,5	11922
TT 119x110	119	110	4,5	4371	TT 125x101	125	101	12	11502
TT 120x50	120	50	35	25317	TT 125x103	125	103	11	10631
TT 120x55	120	55	32,5	24115	TT 125x105	125	105	10	9752
TT 120x60	120	60	30	22891	TT 125x112	125	112	6,5	6533

\* Unless otherwise indicated, profiles are made of EN AW-6060T6 alloy

\* All dimensions are expressed in mm

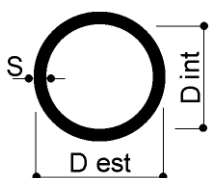

For more sizes of round aluminum tubes visit the site:

[www.tubi-alluminio.it](http://www.tubi-alluminio.it)

## ROUND TUBES

TUBI TONDI	D est	D int	S	GR/MT	TUBI TONDI	D est	D int	S	GR/MT
TT 125x115	125	115	5	5089	TT 132x125	132	125	3,5	3815
TT 125x117	125	117	4	4105	TT 133x105	133	105	14	14132
TT 125x119	125	119	3	3102	TT 133x123	133	123	5	5427
TT 125x120	125	120	2,5	2596	TT 133x128	133	128	2,5	2775
TT 125x122	125	122	1,5	1571	TT 134x107	134	107	13,5	13791
TT 125,1x121,50	125,1	121,5	1,8	1883	TT 134x120	134	120	7	7541
TT 126x106	126	106	10	9875	TT 134x130	134	130	2	2238
TT 126x110	126	110	8	8003	TT 135x65	135	65	35	29670
TT 126x120	126	120	3	3130	TT 135x75	135	75	30	26710
TT 126,9x121,9	126,9	121,9	2,5	2637	TT 135x85	135	85	25	23310
TT 127x88,90	127	88,9	19,05	~19500	TT 135x90	135	90	22,5	21460
TT 127x119,5	127	119,5	3,75	3934	TT 135x95	135	95	20	19509
TT 127x120	127	120	3,5	3665	TT 135x100	135	100	17,5	17430
TT 127x123	127	123	2	2120	TT 135x115	135	115	10	10600
TT 127x124	127	124	1,5	1596	TT 135x119	135	119	8	8610
TT 128x113	128	113	7,5	7664	TT 135x120	135	120	7,5	8110
TT 128x121	128	121	3,5	3695	TT 135x125	135	125	5	5513
TT 128x122	128	122	3	3191	TT 135x129	135	129	3	3359
TT 129x125	129	125	2	2154	TT 135x131	135	131	2	2256
TT 130x45	130	45	42,5	~31500	TT 135,5x95	135,5	95	20,25	19791
TT 130x46	130	46	42	31351	TT 135,5x102	135,5	102	16,75	16867
TT 130x50	130	50	40	30500	TT 135,6x114,30	135,6	114,3	10,65	11282
TT 130x60	130	60	35	28190	TT 136x122	136	122	7	7656
TT 130x70	130	70	30	25447	TT 136x130	136	130	3	3384
TT 130x75	130	75	27,5	~23800	TT 136x132	136	132	2	2273
TT 130x80	130	80	25	22255	TT 137x130	137	130	3,5	3961
TT 130x85	130	85	22,5	20510	TT 138x115	138	115	11,5	12336
TT 130x90	130	90	20	18661	TT 139x127	139	127	6	6765
TT 130x95	130	95	17,5	16690	TT 139,7x82,90	139,7	82,9	28,4	26900
TT 130x100	130	100	15	14625	TT 139,7x119,70	139,7	119,7	10	11002
TT 130x105	130	105	12,5	12458	TT 139,7x131,70	139,7	131,7	4	4607
TT 130x110	130	110	10	10178	TT 140x55	140	55	42,5	~36000
TT 130x114	130	114	8	8270	TT 140x60	140	60	40	34040
TT 130x115	130	115	7,5	7790	TT 140x70	140	70	35	31274
TT 130x118	130	118	6	6311	TT 140x80	140	80	30	27980
TT 130x120	130	120	5	5301	TT 140x90	140	90	25	24370
TT 130x122	130	122	4	4273	TT 140x95	140	95	22,5	22410
TT 130x124	130	124	3	3230	TT 140x100	140	100	20	20358
TT 130x125	130	125	2,5	2703	TT 140x105	140	105	17,5	18170
TT 130x126	130	126	2	2171	TT 140x108	140	108	16	16824
TT 130,15x89,75	130,15	89,75	20,2	18805	TT 140x110	140	110	15	15896
TT 130,2x125,20	130,2	125,2	2,5	2708	TT 140x118,50	140	118,5	10,75	11802
TT 131x96	131	96	17,5	16843	TT 140x120	140	120	10	11021
TT 131x125	131	125	3	3254	TT 140x124	140	124	8	8957
TT 132x85	132	85	23,5	~23100	TT 140x125	140	125	7,5	8456
TT 132x100	132	100	16	15743	TT 140x126	140	126	7	7898
TT 132x110	132	110	11	11290	TT 140x130	140	130	5	5722

\* Unless otherwise indicated, profiles are made of EN AW-6060T6 alloy

\* All dimensions are expressed in mm

Via Newton, n.12  
20016 Pero (Milano - Italy)  
Tel. +39 02 3535955 r.a. Fax. +39 02 3539929  
E-Mail: info@omar-alluminio.it

Cataloghi Online: [www.omar-alluminio.it](http://www.omar-alluminio.it)  
[www.omar-alluminio.com](http://www.omar-alluminio.com)  
CUSTOM ALUMINUM PROFILES / STANDARD / SPECIAL / AND FOR:  
ELECTRONICS / LED / PHOTOVOLTAIC / ROBOTIC AUTOMATION / PNEUMATICS / AUTOMOTIVE



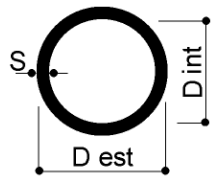

For more sizes of round aluminum tubes visit the site:

[www.tubi-alluminio.it](http://www.tubi-alluminio.it)

## ROUND TUBES

TUBI TONDI	D est	D int	S	GR/MT	TUBI TONDI	D est	D int	S	GR/MT
TT 140x131	140	131	4,5	5173	TT 151,8x143,80	151,8	143,8	4	5015
TT 140x132	140	132	4	4631	TT 152x75	152	75	38,5	37070
TT 140x133	140	133	3,5	4052	TT 152x130	152	130	11	13156
TT 140x134	140	134	3	3486	TT 152x136	152	136	8	9772
TT 140x136	140	136	2	2341	TT 152x139	152	139	6,5	8018
TT 140,1x132,50	140,1	132,5	3,8	4566	TT 152x144	152	144	4	5020
TT 141x100,50	141	100,5	20,25	20741	TT 152x146	152	146	3	3790
TT 141x134	141	134	3,5	4079	TT 152,4x101,60	152,4	101,6	25,4	~27000
TT 141x135	141	135	3	3512	TT 153x101	153	101	26	27994
TT 142x88	142	88	27	26320	TT 153x127	153	127	13	15434
TT 144x132	144	132	6	7023	TT 155x94	155	94	30,5	~32400
TT 145x80	145	80	32,5	~36500	TT 155x95	155	95	30	31790
TT 145x95	145	95	25	~28000	TT 155x100	155	100	27,5	29733
TT 145x98	145	98	23,5	~26400	TT 155x105	155	105	25	27550
TT 145x112	145	112	16,5	17980	TT 155x110	155	110	22,5	25280
TT 145x115	145	115	15	~16800	TT 155x115	155	115	20	22997
TT 145x120	145	120	12,5	14042	TT 155x120	155	120	17,5	20400
TT 145x125	145	125	10	11451	TT 155x121	155	121	17	19900
TT 145x133	145	133	6	7076	TT 155x125	155	125	15	17800
TT 145x135	145	135	5	5936	TT 155x129	155	129	13	15658
TT 145x137	145	137	4	4784	TT 155x135	155	135	10	12298
TT 145x139	145	139	3	3613	TT 155x139	155	139	8	9970
TT 145x140	145	140	2,5	3018	TT 155x140	155	140	7,5	9380
TT 146x130	146	130	8	9366	TT 155x142	155	142	6,5	8188
TT 148x85	148	85	31,5	~37000	TT 155x145	155	145	5	6360
TT 148x94	148	94	27	~31000	TT 155x149	155	149	3	3866
TT 149x140	149	140	4,5	5516	TT 156x140	156	140	8	10043
TT 150x60	150	60	45	~45800	TT 156x150	156	150	3	3891
TT 150x70	150	70	40	~40600	TT 156,3x133,30	156,3	133,3	11,5	14125
TT 150x90	150	90	30	30536	TT 157x150	157	150	3,5	4555
TT 150x100	150	100	25	26494	TT 157x151	157	151	3	3921
TT 150x105	150	105	22,5	24320	TT 158x110	158	110	24	27265
TT 150x110	150	110	20	22043	TT 158x140	158	140	9	11375
TT 150x115	150	115	17,5	19660	TT 158,1x151,20	158,1	151,2	3,45	4525
TT 150x120	150	120	15	17168	TT 159x151	159	151	4	5259
TT 150x125	150	125	12,5	14600	TT 159x152,60	159	152,6	3,2	4228
TT 150x128	150	128	11	~12800	TT 160x50	160	50	55	~60500
TT 150x130	150	130	10	11870	TT 160x62	160	62	49	~53900
TT 150x134	150	134	8	9631	TT 160x90	160	90	35	~38700
TT 150x135	150	135	7,5	9060	TT 160x100	160	100	30	33060
TT 150x136	150	136	7	8486	TT 160x110	160	110	25	28610
TT 150x138	150	138	6	7329	TT 160x115	160	115	22,5	26230
TT 150x140	150	140	5	6147	TT 160x120	160	120	20	23738
TT 150x142	150	142	4	4954	TT 160x125	160	125	17,5	21140
TT 150x144	150	144	3	3739	TT 160x130	160	130	15	18440
TT 150x145	150	145	2,5	3127	TT 160x136	160	136	12	15065
TT 150x146	150	146	2	2509	TT 160x140	160	140	10	12717

\* Unless otherwise indicated, profiles are made of EN AW-6060T6 alloy

\* All dimensions are expressed in mm

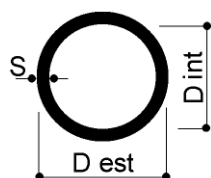

For more sizes of round aluminum tubes  
visit the site:

[www.tubi-alluminio.it](http://www.tubi-alluminio.it)

## ROUND TUBES

TUBI TONDI	D est	D int	S	GR/MT	TUBI TONDI	D est	D int	S	GR/MT
TT 160x144	160	144	8	10314	TT 170x133	170	133	18,5	23770
TT 160x145	160	145	7,5	9700	TT 170x135	170	135	17,5	22630
TT 160x146	160	146	7	9086	TT 170x140	170	140	15	19721
TT 160x148	160	148	6	7800	TT 170x145	170	145	12,5	16700
TT 160x150	160	150	5	6570	TT 170x150	170	150	10	13571
TT 160x152	160	152	4	5293	TT 170x152	170	152	9	12290
TT 160x154	160	154	3	3995	TT 170x154	170	154	8	10990
TT 160x155	160	155	2,5	3340	TT 170x160	170	160	5	6998
TT 160x156	160	156	2	2679	TT 170x164	170	164	3	4250
TT 161x132	161	132	14,5	19679	TT 170x164,60	170	164,6	2,7	3831
TT 162x138	162	138	12	15268	TT 171x108	171	108	31,5	37273
TT 162x152	162	152	5	6657	TT 172x112	171	112	29,5	361
TT 163x152	163	152	5,5	7412	TT 172x158	172	158	7	9797
TT 164x150	164	150	7	9317	TT 172x166	172	166	3	4301
TT 164x152	164	152	6	8039	TT 175x145	175	145	15	20358
TT 165x95	165	95	35	38600	TT 175x161	175	161	7	9975
TT 165x104	165	104	30,5	~35000	TT 175x165	175	165	5	7208
TT 165x105	165	105	30	34340	TT 176x147	176	147	14,5	19863
TT 165x115	165	115	25	29688	TT 178x149	178	149	14,5	~20000
TT 165x120	165	120	22,5	27180	TT 180x40	180	40	70	~77100
TT 165x125	165	125	20	24590	TT 180x70	180	70	55	~60600
TT 165x130	165	130	17,5	21880	TT 180x80	180	80	50	55135
TT 165x135	165	135	15	19080	TT 180x82	180	82	49	54448
TT 165x145	165	145	10	13140	TT 180x100	180	100	40	47501
TT 165x149	165	149	8	10650	TT 180x115	180	115	32,5	40700
TT 165x150	165	150	7,5	10020	TT 180x120	180	120	30	~37700
TT 165x155	165	155	5	6786	TT 180x130	180	130	25	32869
TT 165x157	165	157	4	5463	TT 180x135	180	135	22,5	30040
TT 165x161	165	161	2	2764	TT 180x140	180	140	20	27130
TT 166x160	166	160	3	4146	TT 180x144	180	144	18	24722
TT 167x130	167	130	18,5	23304	TT 180x145	180	145	17,5	24110
TT 167x150	167	150	8,5	11430	TT 180x150	180	150	15	20993
TT 167x154	167	154	6,5	8845	TT 180x155	180	155	12,5	17761
TT 167x156	167	156	5,5	7534	TT 180x156	180	156	12	17100
TT 168x104	168	104	32	~44700	TT 180x160	180	160	10	14413
TT 168x161,20	168	161,2	3,4	4746	TT 180x164	180	164	8	11668
TT 168,3x154,1	168,3	154,1	7,1	9708	TT 180x165	180	165	7,5	10971
TT 168,3x160,30	168,3	160,3	4	5570	TT 180x166	180	166	7	11665
TT 168,3x164,3	168,3	164,3	2	2833	TT 180x168	180	168	6	8566
TT 170x70	170	70	50	55110	TT 180x170	180	170	5	7418
TT 170x90	170	90	40	44080	TT 180x174	180	174	3	4502
TT 170x100	170	100	35	40100	TT 180x174,60	180	174,6	2,7	4061
TT 170x110	170	110	30	35608	TT 180x175	180	175	2,5	3763
TT 170x115	170	115	27,5	33240	TT 181x127	181	127	27	35268
TT 170x120	170	120	25	30730	TT 183x123,50	183	123,5	29,75	~42900
TT 170x125	170	125	22,5	28140	TT 183x157	183	157	13	18746
TT 170x130	170	130	20	25447	TT 183,5x167,20	183,5	167,2	8,15	~11000

\* Unless otherwise indicated, profiles are made of EN AW-6060T6 alloy

\* All dimensions are expressed in mm

Via Newton, n.12  
20016 Pero (Milano - Italy)  
Tel. +39 02 3535955 r.a. Fax. +39 02 3539929  
E-Mail: info@omar-alluminio.it

Cataloghi Online: [www.omar-alluminio.it](http://www.omar-alluminio.it)  
[www.omat-alluminio.com](http://www.omat-alluminio.com)  
CUSTOM ALUMINUM PROFILES / STANDARD / SPECIAL / AND FOR:  
ELECTRONICS / LED / PHOTOVOLTAIC / ROBOTIC AUTOMATION / PNEUMATICS / AUTOMOTIVE



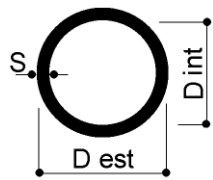

For more sizes of round aluminum tubes  
visit the site:

[www.tubi-alluminio.it](http://www.tubi-alluminio.it)

## ROUND TUBES

TUBI TONDI	D est	D int	S	GR/MT	TUBI TONDI	D est	D int	S	GR/MT
TT 184x107	184	107	38,5	~57400	TT 200x188	200	188	6	9873
TT 184x155	184	155	14,5	20847	TT 200x190	200	190	5	8270
TT 184x168	184	168	8	11942	TT 200x192	200	192	4	6650
TT 184x176	184	176	4	6107	TT 200x194	200	194	3	5013
TT 185x135	185	135	25	33920	TT 200x196	200	196	2	6650
TT 185x145	185	145	20	27977	TT 202x164	202	164	19	29492
TT 185x160	185	160	12,5	18290	TT 203x118	203	118	42,5	57900
TT 185x165	185	165	10	14850	TT 203x152,20	203	152,2	25,4	39000
TT 185x167	185	167	9	13430	TT 203x170	203	170	16,5	26300
TT 185x168	185	168	8,5	12,722	TT 203x177	203	177	13	~20700
TT 186x108	186	108	39	48630	TT 203x196,5	203	196,5	3,25	10835
TT 188x80	188	80	54	~81000	TT 203,2x152,40	203,2	152,4	25,4	~40000
TT 189x120	189	120	34,5	~52000	TT 205x171	205	171	17	27111
TT 190x120	190	120	35	~52300	TT 205x180	205	180	12,5	20529
TT 190x135	190	135	27,5	~41000	TT 205x185	205	185	10	16550
TT 190x145	190	145	22,5	~33672	TT 206x156	206	156	25	38300
TT 190x155	190	155	17,5	25599	TT 208x146	208	146	31	46540
TT 190x150	190	150	20	28840	TT 208x200	208	200	4	6922
TT 190x160	190	160	15	22448	TT 210x140	210	140	35	~54900
TT 190x164	190	164	13	19518	TT 210x160	210	160	25	39231
TT 190x165	190	165	12,5	18819	TT 210x170	210	170	20	32233
TT 190x170	190	170	10	15268	TT 210x179,5	210	179,5	15,25	25185
TT 190x175	190	175	7,5	11607	TT 210x180	210	180	15	26246
TT 190x180	190	180	5	7846	TT 210x190	210	190	10	17090
TT 190x184	190	184	3	4759	TT 210x196	210	196	7	12053
TT 191x165	191	165	13	19623	TT 210x200	210	200	5	8700
TT 194x152	194	152	21	30900	TT 212x184	212	184	14	23512
TT 194x184	194	184	5	8016	TT 212x192	212	192	10	17130
TT 195x93	195	93	51	~70000	TT 212x195	212	195	8,5	14672
TT 195,5x99	195,5	99	48,25	~70000	TT 215x192	215	192	11,5	~21000
TT 197x147	197	147	25	36470	TT 218x193	218	193	12,5	21789
TT 200x100	200	100	50	~67800	TT 219x211,50	219	211,5	3,75	6847
TT 200x104	200	104	48	~65000	TT 220x150	220	150	35	~57900
TT 200x110	200	110	45	~61300	TT 220x170	220	170	25	41351
TT 200x120	200	120	40	54260	TT 220x175	220	175	22,5	37692
TT 200x130	200	130	35	~51900	TT 220x180	220	180	20	34040
TT 200x140	200	140	30	~44500	TT 220x185	220	185	17,5	30059
TT 200x150	200	150	25	37092	TT 220x190	220	190	15	26000
TT 200x155	200	155	22,5	33860	TT 220x192	220	192	14	24463
TT 200x160	200	160	20	30636	TT 220x196	220	196	12	21172
TT 200x165	200	165	17,5	27080	TT 220x200	220	200	10	17800
TT 200x170	200	170	15	23526	TT 220x204	220	204	8	14386
TT 200x175	200	175	12,5	19879	TT 220x207	220	207	6,5	11765
TT 200x176	200	176	12	19136	TT 220x208	220	208	6	10891
TT 200x178,50	200	178,5	10,75	17256	TT 220x210	220	210	5	9118
TT 200x180	200	180	10	16116	TT 222x145	222	145	38,5	~59000
TT 200x184	200	184	8	13029	TT 222x190	222	190	16	~24500

\* Unless otherwise indicated, profiles are made of EN AW-6060T6 alloy

\* All dimensions are expressed in mm

Via Newton, n.12  
20016 Pero (Milano - Italy)  
Tel. +39 02 3535955 r.a. Fax. +39 02 3539929  
E-Mail: info@omar-alluminio.it

Cataloghi Online: [www.omar-alluminio.it](http://www.omar-alluminio.it)  
[www.omar-alluminio.com](http://www.omar-alluminio.com)

CUSTOM ALUMINIUM PROFILES / STANDARD / SPECIAL / AND FOR:  
ELECTRONICS / LED / PHOTOVOLTAIC / ROBOTIC AUTOMATION / PNEUMATICS / AUTOMOTIVE

**OMAR** s.r.l.  
PROFILATI ALLUMINIO  
ALTA TECNOLOGIA

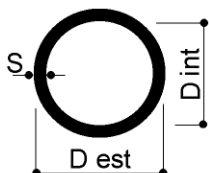

For more sizes of round aluminum tubes  
visit the site:

[www.tubi-alluminio.it](http://www.tubi-alluminio.it)

## ROUND TUBES

TUBI TONDI	D est	D int	S	GR/MT	TUBI TONDI	D est	D int	S	GR/MT
TT 224x138	224	138	43	66100	TT 249x220	249	220	14,5	28842
TT 224x194	224	194	15	26592	TT 249,7x220,30	249,7	220,3	14,7	29300
TT 226x180	226	180	23	39604	TT 250x150	250	150	50	84800
TT 227x190	227	190	18,5	32718	TT 250x180	250	180	35	64300
TT 228x190	228	190	19	33700	TT 250x210	250	210	20	39000
TT 228x200	228	200	14	25400	TT 250x220	250	220	15	30000
TT 228,6x177,80	228,6	177,8	25,4	~43000	TT 250x222	250	222	14	28026
TT 229x178	229	178	25,5	43000	TT 250x226	250	226	12	24214
TT 230x143	230	143	43,5	~73000	TT 250x228	250	228	11	22300
TT 230x160	230	160	35	~59500	TT 250x230	250	230	10	20358
TT 230x170	230	170	30	50890	TT 250x234	250	234	8	16421
TT 230x180	230	180	25	~45800	TT 250x236	250	236	7	14450
TT 230x190	230	190	20	36682	TT 250x238	250	238	6	12418
TT 230x198	230	198	16	29100	TT 250x240	250	240	5	10391
TT 230x200	230	200	15	27356	TT 252x234	252	234	9	~18000
TT 230x210	230	210	10	18700	TT 253x221	253	221	16	32170
TT 230x214	230	214	8	15060	TT 254x203	254	203	25,5	49300
TT 230x220	230	220	5	9543	TT 254x203,20	254	203,2	25,4	49300
TT 232x190	232	190	21	37600	TT 254x218	254	218	18	37112
TT 232x210	232	210	11	22354	TT 254x238	254	238	8	16689
TT 233,5x200	233,5	200	16,75	32496	TT 254x240	254	240	7	14660
TT 234x218	234	218	8	15336	TT 254x242	254	242	6	12630
TT 235x115	235	115	60	89100	TT 255x200	255	200	27,5	53060
TT 235x200	235	200	17,5	32277	TT 256x230	256	230	13	~27400
TT 235x210	235	210	12,5	~18600	TT 256x240	256	240	8	16830
TT 235,5x193	235,5	193	21,25	38618	TT 258x249	258	249	4,5	9677
TT 236x196	236	196	20	36634	TT 259,7x230,30	259,7	230,3	14,7	30550
TT 236x210	236	210	13	24584	TT 260x150	260	150	55	~94400
TT 238x224	238	224	7	13716	TT 260x230	260	230	15	31328
TT 240x140	240	140	50	~84800	TT 260x234	260	234	13	27700
TT 240x160	240	160	40	67858	TT 260x240	260	240	10	23443
TT 240x170	240	170	35	60830	TT 260x250	260	250	5	10815
TT 240x180	240	180	30	53500	TT 260x254	260	254	3	6800
TT 240x200	240	200	20	40310	TT 262x190,50	262	190,5	35,75	68700
TT 240x210	240	210	15	28628	TT 262x250	262	250	6	13100
TT 240x213	240	213	13,5	26100	TT 262,5x252,50	262,5	252,5	5	10920
TT 240x220	240	220	10	19509	TT 264x250	264	250	7	15260
TT 240x226	240	226	7	13831	TT 266x241	266	241	12,5	27859
TT 240x230	240	230	5	9960	TT 267x247	267	247	10	21800
TT 243x195	243	195	24	44583	TT 270x175	270	175	47,5	~103000
TT 244x210	244	210	17	32800	TT 270x180	270	180	45	~97700
TT 244,4x209,80	244,4	209,8	17,3	33326	TT 270x230	270	230	20	43668
TT 244,5x229,50	244,5	229,5	7,5	15077	TT 270x240	270	240	15	32550
TT 245x140	245	140	52,5	~99000	TT 270x250	270	250	10	22054
TT 245x192	245	192	26,5	~50000	TT 272x260	272	260	6	13487
TT 245x225	245	225	10	19933	TT 273,05x236,53	273,05	236,53	18,26	39500
TT 246x230	246	230	8	16150	TT 274x254	274	254	10	22393

\* Unless otherwise indicated, profiles are made of EN AW-6060T6 alloy

\* All dimensions are expressed in mm

Via Newton, n.12  
20016 Pero (Milano - Italy)  
Tel. +39 02 3535955 r.a. Fax. +39 02 3539929  
E-Mail: info@omar-alluminio.it

Cataloghi Online: [www.omar-alluminio.it](http://www.omar-alluminio.it)  
[www.omar-alluminio.com](http://www.omar-alluminio.com)  
CUSTOM ALUMINUM PROFILES / STANDARD / SPECIAL / AND FOR:  
ELECTRONICS / LED / PHOTOVOLTAIC / ROBOTIC AUTOMATION / PNEUMATICS / AUTOMOTIVE



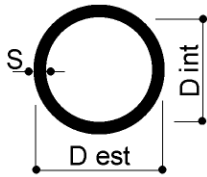

For more sizes of round aluminum tubes visit the site:

[www.tubi-alluminio.it](http://www.tubi-alluminio.it)

## ROUND TUBES

TUBI TONDI	D est	D int	S	GR/MT	TUBI TONDI	D est	D int	S	GR/MT
TT 274,5x232,50	274,5	232,5	21	45156	TT 317,5x284,50	317,5	284,5	16,5	~43400
TT 276x266	276	266	5	11494	TT 320x270	320	270	25	62600
TT 277x125	277	125	76	~163000	TT 320x290	320	290	15	39957
TT 280x125	280	125	77,5	~167000	TT 320x300	320	300	10	26295
TT 280x180	280	180	50	~108000	TT 320x308	320	308	6	~15700
TT 280x230	280	230	25	54075	TT 322x288	322	288	17	43981
TT 280x252	280	252	14	31821	TT 322x296	322	296	13	34145
TT 280x255	280	255	12,5	28474	TT 322x310	322	310	6	16080
TT 280x260	280	260	10	22901	TT 323x289	323	289	17	45735
TT 280x264	280	264	8	18594	TT 324x311	324	311	6,5	17505
TT 280x266	280	266	7	16210	TT 324x313	324	313	5,5	14858
TT 282x250	282	250	16	36102	TT 325x291	325	291	17	44576
TT 285x233	285	233	26	57337	TT 325x292	325	292	16,5	43177
TT 285x235	285	235	25	55130	TT 330x280	330	280	25	64678
TT 285x245	285	245	20	44956	TT 330x305	330	305	12,5	33700
TT 285x260	285	260	12,5	28962	TT 330x317	330	317	6,5	~16800
TT 287x124	287	124	81,5	~173000	TT 336x292	336	292	22	58596
TT 296x256	296	256	20	~49000	TT 340x324	340	324	8	22530
TT 296x282	296	282	7	17159	TT 350x314	350	314	18	50700
TT 300x235	300	235	32,5	73743	TT 350x318	350	318	16	45329
TT 300x268	300	268	16	38524	TT 350x330	350	330	10	28840
TT 300x269	300	269	15,5	~38000	TT 350x334	350	334	8	23208
TT 300x280	300	280	10	24582	TT 355x325	355	325	15	43260
TT 300x284	300	284	8	19815	TT 356x326	356	326	15	43387
TT 300x286	300	286	7	17397	TT 360x280	360	280	40	112530
TT 300x288	300	288	6	14963	TT 360x326	360	326	17	49561
TT 300x292	300	292	4	10043	TT 364,5x325	364,5	325	19,75	59954
TT 301x270	301	270	15,5	37668	TT 365x314	365	314	25,5	73434
TT 301x271	301	271	15	40028	TT 365x331	365	331	17	50181
TT 302x290	302	290	6	~14500	TT 366x350	366	350	8	24295
TT 303x250	303	250	26,5	62200	TT 367x347	367	347	10	30282
TT 303x267	303	267	18	43500	TT 370x338	370	338	16	48044
TT 304x227	304	227	38,5	89869	TT 370x350	370	350	10	30536
TT 306x284	306	284	11	27525	TT 370x354	370	354	8	24565
TT 308x272	308	272	18	~44500	TT 372x360	372	360	6	18627
TT 310x250	310	250	30	71250	TT 374x348	374	348	13	40986
TT 310x255	310	255	27,5	65897	TT 378x335	378	335	21,5	65015
TT 310x260	310	260	25	60574	TT 380x334	380	334	23	69648
TT 310x270	310	270	20	49197	TT 380x360	380	360	10	31385
TT 310x294	310	294	8	20500	TT 386x346	386	346	20	62090
TT 312x282,50	312	282,5	14,75	37190	TT 386x350	386	350	18	56187
TT 312x300	312	300	6	15574	TT 390x338	390	338	26	80276
TT 312,5x299,50	312,5	299,5	6,5	16872	TT 392x380	392	380	6	19640
TT 312,5x302,5	312,5	302,5	5	13040	TT 394x380	394	380	7	23647
TT 315x285	315	285	15	38200	TT 395x375	395	375	10	32657
TT 315x300	315	300	7,5	19600	TT 398x384	398	384	7	23300
TT 317x247	317	247	35	86777	TT 400x360	400	360	20	64465

\* Unless otherwise indicated, profiles are in EN AW-6060T6 alloy, extruded only (not drawn)

\* All dimensional measurements are expressed in mm



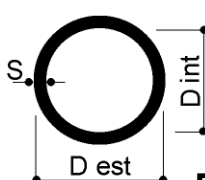

For more sizes of round aluminum tubes  
visit the site:

[www.tubi-alluminio.it](http://www.tubi-alluminio.it)

## ROUND TUBES

TUBI TONDI	D est	D int	S	GR/MT
TT 400x368	400	368	16	52115
TT 400x380	400	380	10	33000
TT 402x380	402	380	11	36480
TT 406x390	406	390	8	27000
TT 407x371	407	371	18	59393
TT 410x374	410	374	18	59851
TT 412x360	412	360	26	85200
TT 412x383	412	383	14,5	48890
TT 414x400	414	400	7	24166
TT 418x396	418	396	11	37975
TT 442x420	442	420	11	40300
TT 450x426	450	426	12	44600
TT 450x430	450	430	10	37330
TT 450x436	450	436	7	26304
TT 454x434	454	434	10	37650
TT 464x407	464	407	28,5	105280
TT 466x444,40	466	444,4	10,8	41800
TT 471x456	471	456	7,5	29487
TT 480x460	480	460	10	42983
TT 488x464	488	464	12	94459
TT 493x469,80	493	469,8	11,6	44900
TT 495x470	495	470	12,5	51150
TT 512x500	512	500	6	25752
TT 542x428	542	428	57	23500
TT 550x530	550	530	10	45800
TT 580x560	580	560	10	48349
TT 600x580	600	580	10	50046

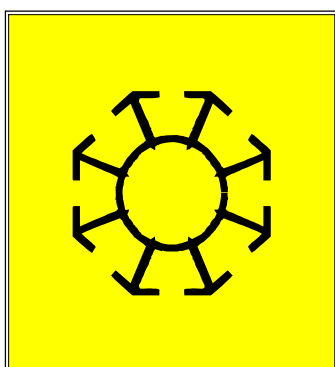

Pdf catalog profiles for exhibition stands / showcases, exhibitors:  
[www.stand.alluminio.eu](http://www.stand.alluminio.eu)

\* Unless otherwise indicated, profiles are in EN AW-6060T6 alloy, extruded only (not drawn)  
\* All dimensional measurements are expressed in mm

Via Newton, n.12  
20016 Pero (Milano - Italy)  
Tel. +39 02 3535955 r.a. Fax. +39 02 3539929  
E-Mail: [info@omar-alluminio.it](mailto:info@omar-alluminio.it)

Cataloghi Online: [www.omar-alluminio.it](http://www.omar-alluminio.it)  
[www.omar-alluminio.com](http://www.omar-alluminio.com)  
CUSTOM ALUMINUM PROFILES / STANDARD / SPECIAL / AND FOR:  
ELECTRONICS / LED / PHOTOVOLTAIC / ROBOTIC AUTOMATION / PNEUMATICS / AUTOMOTIVE



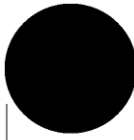

## ROUND BARS

## ROUND BARS

BARRE TONDE	D	GR/MT	BARRE TONDE	D	GR/MT
BT 3	3	20	BT 14,2	14,2	428
BT 3,5	3,5	26	BT 14,5	14,5	446
BT 3,7	3,7	30	BT 14,6	14,6	452
BT 4	4	34	BT 14,7	14,7	458
BT 5	5	53	BT 15	15	477
BT 5,3	5,3	59	BT 15,2	15,2	490
BT 5,35	5,35	61	BT 15,5	15,5	509
BT 5,7	5,7	70	BT 15,88	15,88	535
BT 5,9	5,9	74	BT 15,9	15,9	537
BT 6	6	76	BT 16	16	542
BT 6,3	6,3	79	BT 16,2	16,2	557
BT 7	7	104	BT 16,3	16,3	563
BT 8	8	136	BT 16,4	16,4	570
BT 8,5	8,5	153	BT 16,7	16,7	591
BT 9	9	172	BT 17	17	613
BT 9,2	9,2	179	BT 17,2	17,2	627
BT 9,4	9,4	187	BT 17,5	17,5	649
BT 9,5	9,5	191	BT 18	18	687
BT 9,7	9,7	200	BT 18,2	18,2	702
BT 9,8	9,8	204	BT 18,3	18,3	710
BT 10	10	212	BT 18,5	18,5	725
BT 10,1	10,1	216	BT 19	19	765
BT 10,2	10,2	221	BT 19,2	19,2	782
BT 10,3	10,3	225	BT 19,7	19,7	823
BT 10,5	10,5	234	BT 20	20	848
BT 10,8	10,8	247	BT 20,2	20,2	865
BT 10,9	10,9	252	BT 20,4	20,4	883
BT 11	11	256	BT 20,5	20,5	891
BT 11,2	11,2	266	BT 20,6	20,6	900
BT 11,4	11,4	276	BT 20,9	20,9	926
BT 11,5	11,5	280	BT 21	21	935
BT 11,7	11,7	290	BT 21,2	21,2	953
BT 11,9	11,9	300	BT 21,6	21,6	989
BT 12	12	305	BT 21,8	21,8	1008
BT 12,2	12,2	316	BT 21,9	21,9	1016
BT 12,3	12,3	321	BT 22	22	1026
BT 12,5	12,5	331	BT 22,2	22,2	1045
BT 12,6	12,6	337	BT 22,6	22,6	1083
BT 12,7	12,7	342	BT 22,9	22,9	1111
BT 13	13	359	BT 23	23	1121
BT 13,2	13,2	369	BT 23,1	23,1	1132
BT 13,5	13,5	386	BT 23,2	23,2	1141
BT 13,8	13,8	404	BT 23,3	23,3	1151
BT 13,9	13,9	410	BT 23,5	23,5	1161
BT 14	14	416	BT 23,6	23,6	1181

\* Unless otherwise indicated, profiles are in EN AW-6060T6 alloy, extruded only (not drawn)

\* All dimensional measurements are expressed in mm

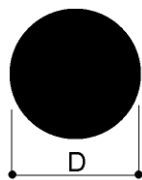

## ROUND BARS

## ROUND BARS

BARRE TONDE	D	GR/MT	BARRE TONDE	D	GR/MT
BT 24	24	1221	BT 34,5	34,5	2524
BT 24,2	24,2	1242	BT 34,8	34,8	2568
BT 24,9	24,9	1315	BT 34,92	34,92	2585
BT 25	25	1325	BT 35	35	2598
BT 25,2	25,2	1347	BT 35,2	35,2	2627
BT 25,3	25,3	1357	BT 35,3	35,3	2642
BT 25,4	25,4	1368	BT 35,5	35,5	2672
BT 25,5	25,5	1379	BT 36	36	2748
BT 25,8	25,8	1412	BT 36,2	36,2	2779
BT 26	26	1433	BT 36,5	36,5	2824
BT 26,2	26,2	1456	BT 37	37	2902
BT 26,3	26,3	1467	BT 37,3	37,3	2950
BT 26,8	26,8	1523	BT 37,9	37,9	3045
BT 27	27	1545	BT 38	38	3061
BT 27,2	27,2	1569	BT 38,1	38,1	3077
BT 27,55	27,55	1610	BT 38,2	38,2	3094
BT 28	28	1662	BT 38,3	38,3	3111
BT 28,2	28,2	1686	BT 38,5	38,5	3142
BT 28,4	28,4	1710	BT 39	39	3344
BT 28,5	28,5	1722	BT 40	40	3393
BT 28,57	28,57	1731	BT 40,6	40,6	3495
BT 28,6	28,6	1735	BT 40,8	40,8	3530
BT 28,8	28,8	1759	BT 41	41	3563
BT 29	29	1782	BT 41,27	41,27	3610
BT 29,2	29,2	1808	BT 42	42	3738
BT 29,8	29,8	1883	BT 43	43	3921
BT 30	30	1909	BT 43,5	43,5	4011
BT 30,2	30,2	1934	BT 43,8	43,8	4066
BT 30,3	30,3	1947	BT 44	44	4103
BT 31	31	2037	BT 44,45	44,45	4190
BT 31,2	31,2	2064	BT 45	45	4294
BT 31,3	31,3	2078	BT 46	46	4487
BT 31,45	31,45	2097	BT 46,8	46,8	4645
BT 31,5	31,5	2103	BT 47	47	4685
BT 31,7	31,7	2130	BT 47,62	47,62	4806
BT 31,75	31,75	2137	BT 48	48	4886
BT 32	32	2171	BT 49	49	5280
BT 32,10	32,1	2184	BT 49,8	49,8	5256
BT 32,2	32,2	2199	BT 50	50	5301
BT 33	33	2308	BT 50,8	50,8	5472
BT 33,2	33,2	2337	BT 51	51	5719
BT 33,5	33,5	2380	BT 52	52	5734
BT 33,8	33,8	2422	BT 53	53	6177
BT 34	34	2456	BT 53,98	53,98	6176
BT 34,2	34,2	2480	BT 54	54	6183

\* Unless otherwise indicated, profiles are in EN AW-6060T6 alloy, extruded only (not drawn)

\* All dimensional measurements are expressed in mm

Via Newton, n.12

20016 Pero (Milano - Italy)

Tel. +39 02 3535955 r.a. Fax. +39 02 3539929

E-Mail: info@omar-alluminio.it

Cataloghi Online: [www.omar-alluminio.it](http://www.omar-alluminio.it)

[www.omar-alluminio.com](http://www.omar-alluminio.com)

CUSTOM ALUMINUM PROFILES / STANDARD / SPECIAL / AND FOR:

ELECTRONICS / LED / PHOTOVOLTAIC / ROBOTIC AUTOMATION / PNEUMATICS / AUTOMOTIVE



## ROUND BARS

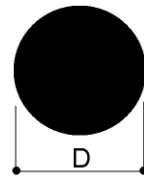

## ROUND BARS

BARRE TONDE	D	GR/MT	BARRE TONDE	D	GR/MT
BT 55	55	6415	BT 87	87	16645
BT 56	56	6650	BT 88	88	17030
BT 57	57	6890	BT 88,9	88,9	16759
BT 57,15	57,15	6923	BT 89	89	17419
BT 57,8	57,8	7085	BT 90	90	17168
BT 58	58	7397	BT 91	91	18210
BT 59	59	7655	BT 92	92	17949
BT 60	60	7630	BT 92,25	92,25	18037
BT 60,32	60,32	7712	BT 93	93	19020
BT 61	61	8183	BT 93,7	93,7	18609
BT 62	62	8151	BT 94	94	19413
BT 62,2	62,2	8200	BT 95	95	19128
BT 63	63	8728	BT 95,25	95,25	19,229
BT 63,5	63,5	8546	BT 96	96	20267
BT 64	64	9007	BT 97	97	20691
BT 65	65	8954	BT 98	98	20356
BT 65,5	65,5	9093	BT 99	99	21553
BT 65,8	65,8	9181	BT 100	100	21195
BT 66	66	9579	BT 101	101	21621
BT 66,7	66,7	9429	BT 101,6	101,6	21879
BT 67	67	9872	BT 102	102	22051
BT 67,7	67,7	9719	BT 103	103	22497
BT 68	68	9806	BT 104	104	22935
BT 69	69	10470	BT 104,77	104,77	23265
BT 69,85	69,85	10341	BT 105	105	23379
BT 70	70	10390	BT 106	106	23815
BT 71	71	11096	BT 107	107	~25600
BT 72	72	11400	BT 107,95	107,95	24710
BT 73	73	11719	BT 108	108	24722
BT 74	74	11612	BT 109	109	~25200
BT 74,5	74,5	11770	BT 110	110	25646
BT 75	75	11922	BT 111	111	26127
BT 76	76	12242	BT 112	112	26587
BT 76,2	76,2	12307	BT 113	113	~27000
BT 77	77	13038	BT 114	114	~27500
BT 78	78	13379	BT 114,3	114,3	27690
BT 79	79	13724	BT 114,5	114,5	27787
BT 80	80	13572	BT 115	115	28030
BT 81	81	13906	BT 116	116	28520
BT 82	82	14786	BT 117	117	29014
BT 82,55	82,55	14450	BT 117,48	117,48	29252
BT 83	83	14609	BT 118	118	29512
BT 84	84	15517	BT 119	119	~30200
BT 85	85	15313	BT 120	120	30521
BT 86	86	16264	BT 120,65	120,65	30521

\* Unless otherwise indicated, profiles are in EN AW-6060T6 alloy, extruded only (not drawn)

\* All dimensional measurements are expressed in mm



## ROUND BARS

## ROUND BARS

BARRE TONDE	D	GR/MT	BARRE TONDE	D	GR/MT
BT 121	121	31000	BT 160	160	54259
BT 122	122	31547	BT 162	162	55624
BT 123	123	~31700	BT 165	165	59870
BT 124	124	~31900	BT 165,1	165,1	57773
BT 125	125	33134	BT 166	166	58405
BT 126	126	33649	BT 167	167	59110
BT 127	127	34185	BT 168	168	59821
BT 128	128	~34400	BT 170	170	63554
BT 129	129	~34700	BT 171,45	141,45	62303
BT 130	130	35838	BT 175	175	67347
BT 130,17	130,17	35913	BT 177,8	177,8	67003
BT 131	131	~36000	BT 178	178	67154
BT 132	132	~36200	BT 180	180	71251
BT 133	133	~36400	BT 184,15	184,15	71875
BT 133,35	133,35	37689	BT 185	185	72540
BT 134	134	~36800	BT 190	190	79347
BT 135	135	40078	BT 190,5	190,5	76917
BT 136	136	~40300	BT 195	195	80594
BT 137	137	~40600	BT 196,85	196,85	82130
BT 138	138	~40900	BT 198	198	83133
BT 139	139	~41200	BT 200	200	87920
BT 139,7	139,7	41364	BT 203,2	203,2	87515
BT 140	140	41563	BT 205	205	89072
BT 141	141	~42200	BT 206	206	89943
BT 142	142	~42800	BT 209	209	92582
BT 143	143	~43400	BT 210	210	96980
BT 144	144	~44000	BT 213	213	96160
BT 145	145	~44600	BT 215	215	97974
BT 146	146	~45200	BT 215,9	215,9	98796
BT 146,05	146,05	45210	BT 219,07	219,07	101718
BT 147	147	45800	BT 220	220	10643
BT 148	148	~46400	BT 225	225	107351
BT 149	149	~47000	BT 228	228	110180
BT 150	150	47713	BT 228,6	228,6	110761
BT 151	151	~47720	BT 230	230	11633
BT 152	152	48969	BT 235	235	117049
BT 152,4	152,4	49251	BT 240	240	12666
BT 153	153	49615	BT 241,3	241,3	123409
BT 154	154	~49700	BT 245	245	127223
BT 155	155	52833	BT 250	250	13744
BT 156	156	~53000	BT 254	254	136742
BT 157	157	~53200	BT 255	255	137820
BT 158	158	~53400	BT 257,12	257,12	137820
BT 158,75	158,75	53415	BT 260	260	143300
BT 159	159	~53800	BT 265	265	148842

\* Unless otherwise indicated, profiles are in EN AW-6060T6 alloy, extruded only (not drawn)

\* All dimensional measurements are expressed in mm

Via Newton, n.12  
20016 Pero (Milano - Italy)  
Tel. +39 02 3535955 r.a. Fax. +39 02 3539929  
E-Mail: info@omar-alluminio.it

Cataloghi Online: [www.omar-alluminio.it](http://www.omar-alluminio.it)  
[www.omar-alluminio.com](http://www.omar-alluminio.com)

CUSTOM ALUMINUM PROFILES / STANDARD / SPECIAL / AND FOR:  
ELECTRONICS / LED / PHOTOVOLTAIC / ROBOTIC AUTOMATION / PNEUMATICS / AUTOMOTIVE



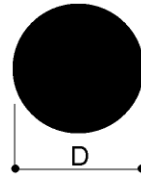

## ROUND BARS

## ROUND BARS

BARRE TONDE	D	GR/MT	BARRE TONDE	D	GR/MT
BT 266,7	266,7	150758	BT 370	370	290300
BT 270	270	154511	BT 375	375	299000
BT 273,05	273,05	158022	BT 380	380	306256
BT 274	274	159124	BT 390	390	334320
BT 275	275	160400	BT 400	400	339320
BT 279,4	279,4	165457	BT 403	403	344230
BT 280	280	166200	BT 405	405	347650
BT 282,57	282,57	169233	BT 410	410	369480
BT 283	283	169749	BT 420	420	374879
BT 285	285	172156	BT 440	440	~411000
BT 285,75	285,75	173064	BT 450	450	430400
BT 290	290	179240	BT 460	460	448490
BT 292,1	292,1	180841	BT 470	470	468200
BT 300	300	190900	BT 480	480	488330
BT 304,8	304,8	196908	BT 500	500	530400
BT 305	305	197166	BT 502	502	534120
BT 307,97	307,97	201025	BT 510	510	551280
BT 310	310	203683	BT 520	520	537110
BT 315	315	210307	BT 550	550	653022
BT 320	320	217100	BT 600	600	777150
BT 330	330	231000	BT 610	610	827058
BT 340	340	245014	BT 640	640	900300
BT 350	350	259700	BT 660	660	~930000
BT 360	360	274887			

\* Unless otherwise indicated, profiles are in EN AW-6060T6 alloy, extruded only (not drawn)  
\* All dimensional measurements are expressed in mm

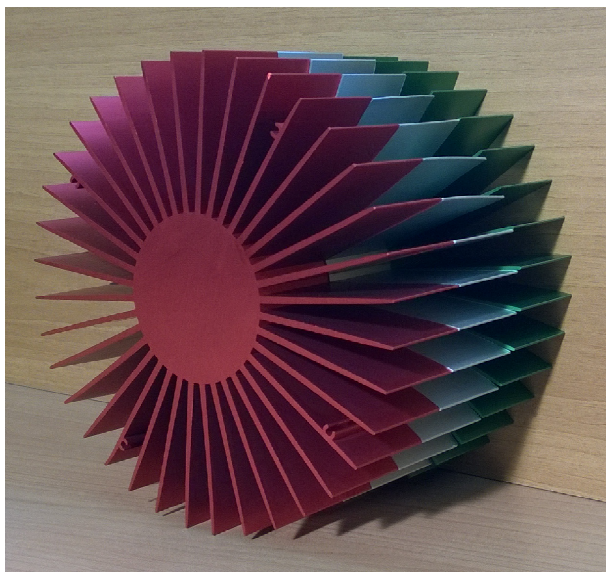

EXAMPLE PHOTO: LARGE ANODIZED ALUMINUM EXTRUDED (FLOWER)



EXAMPLE PHOTO: ROUND HEAT SINKS TYPE "FLOWER" ANODIZED

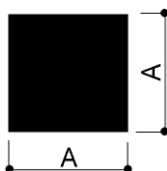

## SQUARE BAR

## SQUARE BAR

BARRE QUADRE	A	GR/MT	BARRE QUADRE	A	GR/MT
BQ 4	4	43	BQ 40	40	4320
BQ 4,5	4,5	55	BQ 40,2	40,2	4363
BQ 5	5	68	BQ 41	41	4706
BQ 6	6	97	BQ 42	42	4939
BQ 7	7	132	BQ 43	43	5177
BQ 8	8	173	BQ 44	44	5420
BQ 9	9	220	BQ 44,45	44,45	5335
BQ 10	10	270	BQ 45	45	5468
BQ 10,2	10,2	281	BQ 45,2	45,2	5516
BQ 11	11	327	BQ 46	46	5924
BQ 12	12	389	BQ 47	47	6185
BQ 12,2	12,2	402	BQ 48	48	6451
BQ 12,3	12,3	408	BQ 49	49	6722
BQ 13	13	456	BQ 50	50	6750
BQ 14	14	529	BQ 50,4	50,4	6858
BQ 14,2	14,2	544	BQ 51	51	7282
BQ 15	15	608	BQ 52	52	7571
BQ 15,4	15,4	640	BQ 53	53	7865
BQ 16	16	691	BQ 54	54	8165
BQ 17	17	780	BQ 55	55	8168
BQ 18	18	875	BQ 56	56	8780
BQ 19	19	975	BQ 57	57	9097
BQ 20	20	1080	BQ 58	58	9419
BQ 21	21	1234	BQ 59	59	9746
BQ 22	22	1307	BQ 60	60	9720
BQ 22,2	22,2	1331	BQ 61	61	10418
BQ 23	23	1481	BQ 62	62	10763
BQ 24	24	1613	BQ 63	63	11113
BQ 25	25	1688	BQ 64	64	11468
BQ 25,4	25,4	1742	BQ 65	65	11408
BQ 26	26	1893	BQ 66	66	12196
BQ 27	27	1968	BQ 67	67	12569
BQ 28	28	2195	BQ 68	68	12947
BQ 29	29	2355	BQ 69	69	13330
BQ 30	30	2430	BQ 70	70	13230
BQ 30,2	30,2	2463	BQ 71	71	14115
BQ 31	31	2690	BQ 72	72	14515
BQ 31,75	31,75	2722	BQ 73	73	14921
BQ 32	32	2765	BQ 74	74	15332
BQ 33	33	3049	BQ 75	75	15188
BQ 34	34	3236	BQ 76	76	16173
BQ 35	35	3307	BQ 76,2	76,2	15677
BQ 35,5	35,5	3403	BQ 77	77	16601
BQ 36	36	3628	BQ 78	78	17035
BQ 37	37	3833	BQ 79	79	17475
BQ 38	38	4043	BQ 80	80	17280
BQ 39	39	4258	BQ 81	81	18370

\* Unless otherwise indicated, profiles are in EN AW-6060T6 alloy, extruded only (not drawn)

\* All dimensional measurements are expressed in mm

Via Newton, n.12  
20016 Pero (Milano - Italy)  
Tel. +39 02 3535955 r.a. Fax. +39 02 3539929  
E-Mail: info@omar-alluminio.it

Cataloghi Online: [www.omar-alluminio.it](http://www.omar-alluminio.it)  
[www.omar-alluminio.com](http://www.omar-alluminio.com)

CUSTOM ALUMINUM PROFILES / STANDARD / SPECIAL / AND FOR:  
ELECTRONICS / LED / PHOTOVOLTAIC / ROBOTIC AUTOMATION / PNEUMATICS / AUTOMOTIVE



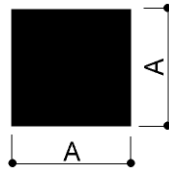

## SQUARE BAR

## SQUARE BAR

BARRE QUADRE	A	GR/MT	BARRE QUADRE	A	GR/MT
BQ 82	82	18827	BQ 110	110	32670
BQ 83	83	19290	BQ 115	115	37030
BQ 84	84	19756	BQ 120	120	40320
BQ 85	85	19506	BQ 125	125	43750
BQ 86	86	20708	BQ 130	130	47230
BQ 87	87	21193	BQ 135	135	51000
BQ 88	88	21683	BQ 140	140	54880
BQ 88,9	88,9	21339	BQ 145	145	58870
BQ 89	89	22178	BQ 150	150	63000
BQ 90	90	21870	BQ 155	155	67270
BQ 91	91	23186	BQ 160	160	71680
BQ 92	92	23649	BQ 165	165	76230
BQ 93	93	24217	BQ 170	170	80920
BQ 94	94	24740	BQ 180	180	87480
BQ 95	95	24638	BQ 190	190	97470
BQ 96	96	25805	BQ 200	200	108000
BQ 97	97	26345	BQ 210	210	119500
BQ 98	98	26891	BQ 220	220	136488
BQ 99	99	27442	BQ 250	250	178125
BQ 100	100	27000	BQ 300	300	256500
BQ 105	105	30870			

\* Unless otherwise indicated, profiles are in EN AW-6060T6 alloy, extruded only (not drawn)

\* All dimensional measurements are expressed in mm



EXAMPLE PHOTO: CUSTOM CUT ALUMINUM PROFILES  
MACHINED AND ANODIZED

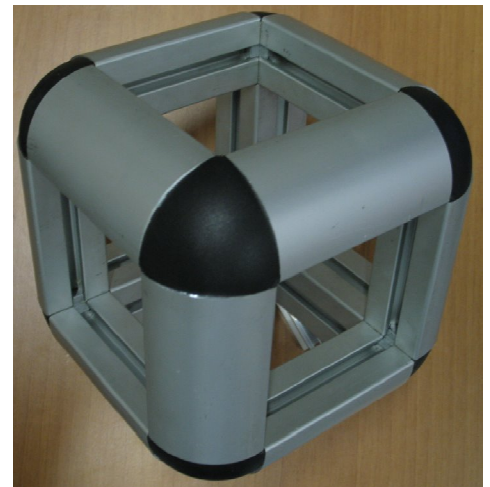



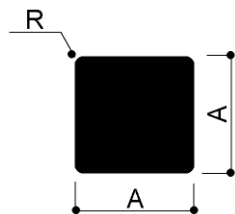

## RADIATED SQUARE BARS

## RADIATED SQUARE BARS

BARRE QUADRE RAGGIATE	A	R	GR/MT	BARRE QUADRE RAGGIATE	A	R	GR/MT
BQR 5x1	5	1	68	BQR 30x0,8	30	0,8	2430
BQR 5,9x1	5,9	1	94	BQR 30x1	30	1	2430
BQR 6x0,5	6	0,5	96	BQR 30x1,5	30	1,5	2430
BQR 6x1	6	1	98	BQR 30x2,5	30	2,5	2416
BQR 6x1,2	6	1,2	94	BQR 30,5x6,5	30,5	6,5	2414
BQR 6x1,5	6	1,5	87	BQR 32x0,8	32	0,8	2765
BQE 7x0,3	7	0,3	129	BQR 32x1	32	1	2765
BQR 8x0,5	8	0,5	172	BQR 32x1,5	32	1,5	2765
BQR 9,3x2	9,3	2	233	BQR 35x1	35	1	3320
BQR 9,8x0,5	9,8	0,5	259	BQR 35x1,5	35	1,5	3308
BQR 9,8x0,8	9,8	0,8	259	BQR 35,2x1	35,2	1	3345
BQR 10x0,6	10	0,6	270	BQR 36X2	36	2	3308
BQR 10x1	10	1	270	BQR 38,10x1,5	38,1	1,5	3919
BQR 10x1,5	10	1,5	270	BQR 40x1	40	1	4320
BQR 10,5x0,5	10,5	0,5	297	BQR 40x1,5	40	1,5	4320
BQR 11x0,5	11	0,5	326	BQR 41x0,5	41	0,5	4539
BQR 12x0,75	12	0,75	386	BQR 42x1	42	1	4763
BQR 12x1,5	12	1,5	389	BQR 42,8x5,5	42,8	5,5	5050
BQR 12,8x0,5	12,8	0,5	441	BQR 42x5	42	5	4763
BQR 15x0,8	15	0,8	608	BQR 43x3	43	3	4992
BQR 15x0,9	15	0,9	605	BQR 44,45x1,5	44,45	1,5	5335
BQR 15x1	15	1	608	BQR 45x0,8	45	0,8	5468
BQR 15,1x0,3	15,1	0,3	612	BQR 45x1	45	1	5467
BQR 15,15x0,5	15,15	0,5	620	BQR 45x1,5	45	1,5	5468
BQR 15,2x0,8	15,2	0,8	624	BQR 46x0,8	46	0,8	5713
BQR 15,2x1	15,2	1	624	BQR 46x1,5	46	1,5	5713
BQR 16x0,8	16	0,8	691	BQR 47x6	47	6	5964
BQR 16,2x0,8	16,2	0,8	709	BQR 50x1	50	1	6750
BQR 16,2x1	16,2	1	709	BQR 50x1,5	50	1,5	6750
BQR 20x0,8	20	0,8	1080	BQR 50,2x1	50,2	1	6804
BQR 20x1	20	1	1080	BQR 50,8x0,9	50,8	0,9	6968
BQR 20,2x0,5	20,2	0,5	1102	BQR 50,8x1	50,8	1	6968
BQR 20,2x0,8	20,2	0,8	1102	BQR 50,8x3	50,8	3	6968
BQR 20,2x1	20,2	1	1102	BQR 55x1,5	55	1,5	8168
BQR 21x0,7	21	0,7	1191	BQR 55x2	55	2	8168
BQR 22x0,8	22	0,8	1307	BQR 55x3	55	3	8168
BQR 22x5	22	5	1250	BQR 57,15x2	57,15	2	8819
BQR 23x1,5	23	1,5	1423	BQR 60x0,5	60	0,5	9719
BQR 25x0,5	25	0,5	1688	BQR 60x1	60	1	9700
BQR 25x0,8	25	0,8	1688	BQR 60x2	60	2	9720
BQR 25x1	25	1	1687	BQR 60x3	60	3	9720
BQR 25x4	25	4	1650	BQR 60x6	60	6	9720
BQR 25,2x1	25,2	1	1715	BQR 61x2	61	2	10047
BQR 25,4X1,5	25,4	1,5	1742	BQR 62x3	62	3	10379
BQR 28x1	28	1	2114	BQR 63,5x2	63,5	2	10887

\* Unless otherwise indicated, profiles are in EN AW-6060T6 alloy, extruded only (not drawn)

\* All dimensional measurements are expressed in mm

Via Newton, n.12  
20016 Pero (Milano - Italy)  
Tel. +39 02 3535955 r.a. Fax. +39 02 3539929  
E-Mail: info@omar-alluminio.it

Cataloghi Online: [www.omar-alluminio.it](http://www.omar-alluminio.it)  
[www.omar-alluminio.com](http://www.omar-alluminio.com)  
CUSTOM ALUMINUM PROFILES / STANDARD / SPECIAL / AND FOR:  
ELECTRONICS / LED / PHOTOVOLTAIC / ROBOTIC AUTOMATION / PNEUMATICS / AUTOMOTIVE



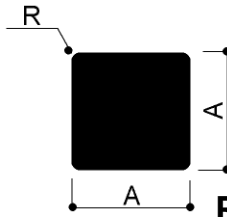

## RADIATED SQUARE BARS

## RADIATED SQUARE BARS

BARRE QUADRE RAGGIATE	A	R	GR/MT	BARRE QUADRE RAGGIATE	A	R	GR/MT
BQR 65x1	65	1	11407	BQR 91x2,5	91	2,5	22359
BQR 65x2	65	2	11408	BQR 92x3	92	3	22853
BQR 65x3	65	3	11408	BQR 95x1	95	1	24368
BQR 66x1	66	1	11761	BQR 95x2	95	2	24267
BQR 70x1	70	1	13200	BQR 95x2,5	95	2,5	24368
BQR 70x2	70	2	13230	BQR 95x3	95	3	24368
BQR 70x3	70	3	13230	BQR 95x10	95	10	24368
BQR 72x1	72	1	13997	BQR 100x1	100	1	27000
BQR 72x3	72	3	13997	BQR 100x2	100	2	27000
BQR 75x1	75	1	15185	BQR 100x2,5	100	2,5	27000
BQR 75x2	75	2	15188	BQR 100x3	100	3	27000
BQR 75x3	75	3	15188	BQR 101,60x1	101,6	1	27869
BQR 75x7,5	75	7,5	15052	BQR 101,60x2	101,6	2	27860
BQR 75x8	75	8	15188	BQR 101,60x2,5	101,6	2,5	27871
BQR 75,5x1,5	75,5	1,5	15384	BQR 101,60x3	101,6	3	27871
BQR 76x1	76	1	15595	BQR 102x3	102	3	28091
BQR 76,2x1	76,2	1	15677	BQR 105x1	105	1	29768
BQR 76,2x2	76,2	2	15677	BQR 105x2	105	2	29657
BQR 76,37x10	76,37	10	15052	BQR 105x2,5	105	2,5	29768
BQR 77x3	77	3	16008	BQR 105x3	105	3	29768
BQR 80x0,5	80	0,5	17279	BQR 107,95x1	107,95	1	31463
BQR 80x1	80	1	1728	BQR 107,95x2,5	107,95	2,5	31464
BQR 80x2	80	2	17280	BQR 110x1	110	1	32670
BQR 80x3	80	3	17280	BQR 110x2	110	2	32670
BQR 80x4	80	4	17280	BQR 110x2,5	110	2,5	32670
BQR 81x2,5	81	2,5	17715	BQR 110x3	110	3	32670
BQR 82x2	82	2	18147	BQR 114,3x1	114,3	1	35274
BQR 82x2,5	82	2,5	18155	BQR 114,3x2,5	114,3	2,5	35274
BQR 82x3	82	3	18155	BQR 115x1	115	1	35708
BQR 82,55x1	82,55	1	18395	BQR 115x2	115	2	35700
BQR 82,55x2,5	82,55	2,5	18399	BQR 115x2,5	115	2,5	35708
BQR 85x1	85	1	19508	BQR 115x3	115	3	35708
BQR 85x2	85	2	19508	BQR 115x12	115	12	35345
BQR 85x2,5	85	2,5	19508	BQR 120x1	120	1	38880
BQR 85x3	85	3	19508	BQR 120x2	120	2	38890
BQR 87x2,5	87	2,5	20436	BQR 120x2,5	120	2,5	38880
BQR 87x3	87	3	20436	BQR 120x3	120	3	38880
BQR 88,9x1	88,9	1	21335	BQR 123x1	123	1	40848
BQR 88,9x2,5	88,9	2,5	21339	BQR 123x2,5	123	2,5	40848
BQR 90x1	90	1	21870	BQR 125x1	125	1	42188
BQR 90x2	90	2	22671	BQR 125x2,5	125	2,5	42188
BQR 90x2,5	90	2,5	21870	BQR 125x3	125	3	42188
BQR 90x3	90	3	21870	BQR 125x4	125	4	42188
BQR 90x8	90	8	21870	BQR 125x12	125	12	42188
BQR 91x2	91	2	22355	BQR 127x1	127	1	43546

\* Unless otherwise indicated, profiles are in EN AW-6060T6 alloy, extruded only (not drawn)

\* All dimensional measurements are expressed in mm

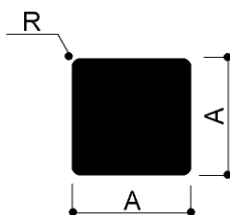

## RADIATED SQUARE BARS

## RADIATED SQUARE BARS

BARRE QUADRE RAGGIATE	A	R	GR/MT	BARRE QUADRE RAGGIATE	A	R	GR/MT
BQR 127x1,6	127	1,6	43534	BQR 160x2,5	160	2,5	69120
BQR 127x2,5	127	2,5	43548	BQR 160x4	160	4	69120
BQR 127x4	127	4	43548	BQR 162x2,5	162	2,5	70859
BQR 130x1	130	1	45630	BQR 165x2,5	165	2,5	73508
BQR 130x2,5	130	2,5	45630	BQR 165x4	165	4	73508
BQR 130x4	130	4	45630	BQR 165,1x2,5	165,1	2,5	73597
BQR 134x4	134	4	48481	BQR 170x2,5	170	2,5	78030
BQR 135x2,5	135	2,5	49208	BQR 170x4	170	4	78030
BQR 135x4	135	4	49208	BQR 175x2,5	175	2,5	82688
BQR 139,7x2,5	139,7	2,5	52693	BQR 175x4	175	4	82688
BQR 140x1	140	1	52920	BQR 177,8x2,5	177,8	2,5	85355
BQR 140x2,5	140	2,5	52920	BQR 180x2,5	180	2,5	87480
BQR 140x4	140	4	52920	BQR 180x4	180	4	87480
BQR 145x2,5	145	2,5	56750	BQR 185x5	185	5	92408
BQR 145x4	145	4	56768	BQR 190x3,5	190	3,5	97470
BQR 150x1	150	1	60750	BQR 190x5	190	5	97470
BQR 150x2,5	150	2,5	60750	BQR 200x3,5	200	3,5	108000
BQR 150x4	150	4	60750	BQR 200x5	200	5	108000
BQR 152,4x1	152,4	1	62694	BQR 203,2x4	203,2	4	111484
BQR 152,4x2,5	152,4	2,5	62710	BQR 210x6	210	6	119070
BQR 155x2,5	155	2,5	64868	BQR 220x6	220	6	130680

\* Unless otherwise indicated, profiles are in EN AW-6060T6 alloy, extruded only (not drawn)

\* All dimensional measurements are expressed in mm

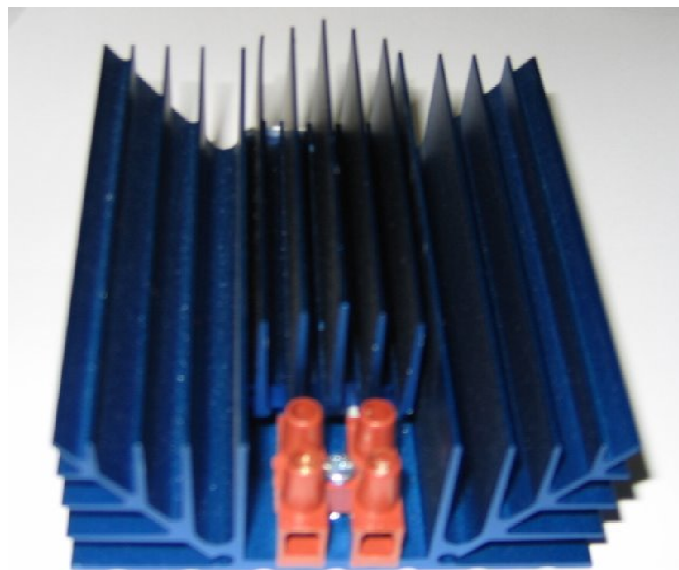

EXAMPLE PHOTO: EXTRUDED AND PROCESSED PROFILES FOR USE AS HEATERS / RESISTANCES

Via Newton, n.12  
20016 Pero (Milano - Italy)  
Tel. +39 02 3535955 r.a. Fax. +39 02 3539929  
E-Mail: info@omar-alluminio.it

Cataloghi Online: [www.omar-alluminio.it](http://www.omar-alluminio.it)  
[www.omar-alluminio.com](http://www.omar-alluminio.com)

CUSTOM ALUMINIUM PROFILES / STANDARD / SPECIAL / AND FOR:  
ELECTRONICS / LED / PHOTOVOLTAIC / ROBOTIC AUTOMATION / PNEUMATICS / AUTOMOTIVE



## HEXAGONAL BARS

## HEXAGONAL BARS

BARRE ESAGONALI	A	GR/MT	BARRE ESAGONALI	A	GR/MT
BE 5	5	61	BE 32	32	2483
BE 6	6	84	BE 33	33	2640
BE 7	7	115	BE 34	34	2803
BE 8	8	155	BE 34,2	34,2	2735
BE 9	9	196	BE 35	35	2970
BE 10	10	234	BE 35,3	35,3	2914
BE 10,3	10,3	257	BE 36	36	3142
BE 11	11	293	BE 36,2	36,2	3178
BE 11,3	11,3	310	BE 37	37	3319
BE 12	12	337	BE 38	38	3501
BE 12,3	12,3	367	BE 39	39	3688
BE 13	13	409	BE 40	40	3879
BE 13,2	13,2	423	BE 40,2	40,2	3919
BE 13,5	13,5	426	BE 41	41	4076
BE 14	14	475	BE 42	42	4277
BE 14,3	14,3	496	BE 43	43	4483
BE 15	15	545	BE 44	44	4694
BE 15,2 r.0,5	15,2	560	BE 45	45	4910
BE 16	16	620	BE 46	46	5131
BE 16,2 r.0,8	16,2	636	BE 47	47	5356
BE 17	17	700	BE 48	48	5586
BE 17,2	17,2	717	BE 49	49	5822
BE 17,3	17,3	726	BE 50	50	6062
BE 18	18	785	BE 51	51	6307
BE 18,2	18,2	803	BE 52	52	6556
BE 19	19	844	BE 53	53	6811
BE 19,2	19,2	894	BE 54	54	7071
BE 19,3	19,3	903	BE 55	55	7335
BE 20	20	969	BE 56	56	7604
BE 20,2	20,2	990	BE 57	57	7878
BE 21	21	1069	BE 58	58	8157
BE 22	22	1132	BE 59	59	8441
BE 22,3	22,3	1206	BE 60	60	8729
BE 23	23	1282	BE 61	61	9023
BE 23,2	23,2	1305	BE 62	62	9321
BE 24	24	1396	BE 63	63	9624
BE 25	25	1515	BE 64	64	9932
BE 25,4	25,4	1510	BE 65	65	10245
BE 26	26	1679	BE 66	66	10562
BE 27	27	1707	BE 67	67	10885
BE 27,2	27,2	1794	BE 68	68	11212
BE 28	28	1901	BE 69	69	11544
BE 28,3	28,3	1942	BE 70	70	11881
BE 29	29	2039	BE 71	71	12223
BE 30	30	2104	BE 72	72	12570
BE 30,2	30,2	2133	BE 73	73	12922
BE 31	31	2330	BE 74	74	13278

\* Unless otherwise indicated, profiles are in EN AW-6060T6 alloy, extruded only (not drawn)  
 \* All dimensional measurements are expressed in mm

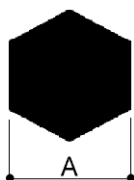

## HEXAGONAL BARS

BARRE ESAGONALI	A	GR/MT
BE 75	75	13639
BE 76	76	14006
BE 77	77	14377
BE 78	78	14753
BE 79	79	15133
BE 80	80	15519
BE 81	81	15909
BE 82	82	16305
BE 83	83	16705
BE 84	84	17109
BE 85	85	17519
BE 86	86	17934
BE 87	87	18353
BE 88	88	18778

## HEXAGONAL BARS

BARRE ESAGONALI	A	GR/MT
BE 89	89	19207
BE 90	90	19641
BE 91	91	20080
BE 92	92	20524
BE 93	93	20972
BE 94	94	21426
BE 95	95	21884
BE 96	96	22347
BE 97	97	22815
BE 98	98	23288
BE 99	99	23766
BE 100	100	24248
BE 125	125	35684

\* Unless otherwise indicated, profiles are in EN AW-6060T6 alloy, extruded only (not drawn)

\* All dimensional measurements are expressed in mm



EXAMPLE PHOTO: ALUMINIUM PROFILES IN STOCK EVEN FOR SMALL QUANTITIES

Via Newton, n.12  
20016 Pero (Milano - Italy)  
Tel. +39 02 3535955 r.a. Fax. +39 02 3539929  
E-Mail: info@omar-alluminio.it

Cataloghi Online: [www.omar-alluminio.it](http://www.omar-alluminio.it)  
[www.omar-alluminio.com](http://www.omar-alluminio.com)

CUSTOM ALUMINIUM PROFILES / STANDARD / SPECIAL / AND FOR:  
ELECTRONICS / LED / PHOTOVOLTAIC / ROBOTIC AUTOMATION / PNEUMATICS / AUTOMOTIVE

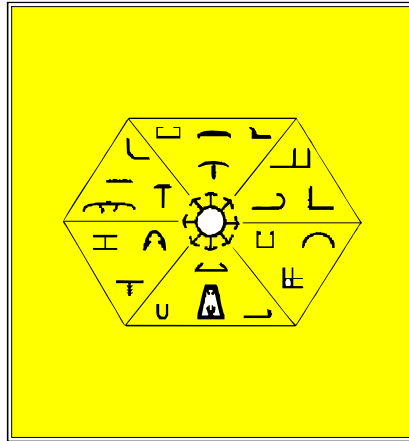

Pdf catalogue special profiles  
nails, glass stops, edgings,  
joint covers, frames, handrails,  
handles, drainers,  
water guards, edge guards,  
corner guards, stair nosings,  
slider holders,  
tag holders, price holders etc...):  
[www.omar-alluminio.it](http://www.omar-alluminio.it)

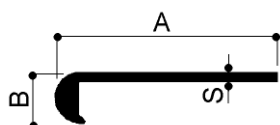

For more sizes of closed aluminum nails  
visit the site:

[www.unghietta-alluminio.biz](http://www.unghietta-alluminio.biz)

## "CLOSED NAIL" PROFILES

PROFILI A "UNGHETTA CHIUSA"	A	B	S	GR/MT
FM3062	13	5	1,2	65
FM3261	13	6	1	60
FM3061	13	7	1,2	80
FM3329	14	10	1,5	~150
FM3060	15	7	1,2	85
FM3245	16	6	0,8	72
	16	7	1	71
FM3328	17	6	1	~100
FM3240	18	6		75
	18	7	1	77
FM3059	18	7	1,2	90
FM3241	20	6	2	80
FM3262	20	6,5	1	83
FM3248	20	7		102
FM3253	20,5	4,9		93
FM3327	21	6,5	1,2	~150
FM3263	22	6		135
FM3058	22	7	1	95
FM3330	22	12	2	~270
FM3257	22,5	6	2	194
FM3170	23	6	2	145
FM3246	25	6		160
	25	7	1	96
FM3057	25	7	1,2	115
FM3269	25	12		174
FM3249	27	8	2	212
FM3242	28	7	1,2	120
FM3056	28	8	1,5	155
FM3243	30	6		103
FM3055	30	7	1,2	125
FM3054	33	7	1,2	130
FM3260	34,5	6		202
FM3076	35	8		305
FM3331	38	7	1,2	~145
FM3268	39	6		225
FM3053	39	9	1,2	190
FM3244	40	7	1,5	185
FM3052	46	7	2	285
FM3051	49	9	1,2	215
FM3332	50	7	1,2	~180

- \* Unless otherwise indicated, profiles are made of EN AW-6060T6 alloy
- \* All dimensional measurements are expressed in mm
- \* Dimensions, shape and weight are purely indicative

Via Newton, n.12  
20016 Pero (Milano - Italy)  
Tel. +39 02 3535955 r.a. Fax. +39 02 3539929  
E-Mail: [info@omar-alluminio.it](mailto:info@omar-alluminio.it)

Cataloghi Online: [www.omar-alluminio.it](http://www.omar-alluminio.it)

[www.omar-alluminio.com](http://www.omar-alluminio.com)

CUSTOM ALUMINUM PROFILES / STANDARD / SPECIAL / AND FOR:

ELECTRONICS / LED / PHOTOVOLTAIC / ROBOTIC AUTOMATION / PNEUMATICS / AUTOMOTIVE



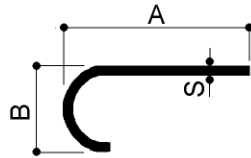

For more sizes of open aluminum nails  
visit the site:

[www.unghietta-alluminio.biz](http://www.unghietta-alluminio.biz)

## "OPEN NAIL" PROFILES

PROFILI A "UNGHETTA APERTA"	A	B	S	GR/MT
FM3264	14	6		54
FM3063	17	5,7	1,1	75
FM3259	18	12		115
FM3072	20	8		85
FM3267	24	14,5		150
FM3247	25	12		117
FM3073	25	13		135
FM3074	27,5	13		195
FM3252	28	7,9	1,4	138
FM3266	29	13		170
FM3065	30	10	1,6	180
FM3250	35,5	6	2	~200
FM3068	40	13		245
FM3075	40	20	2	290
FM3066	40	28	1,9	340

\*Unless otherwise indicated, profiles are made of EN AW-6060T6 alloy

\* All dimensional measurements are expressed in mm

\* Dimensions, shape and weight are purely indicative

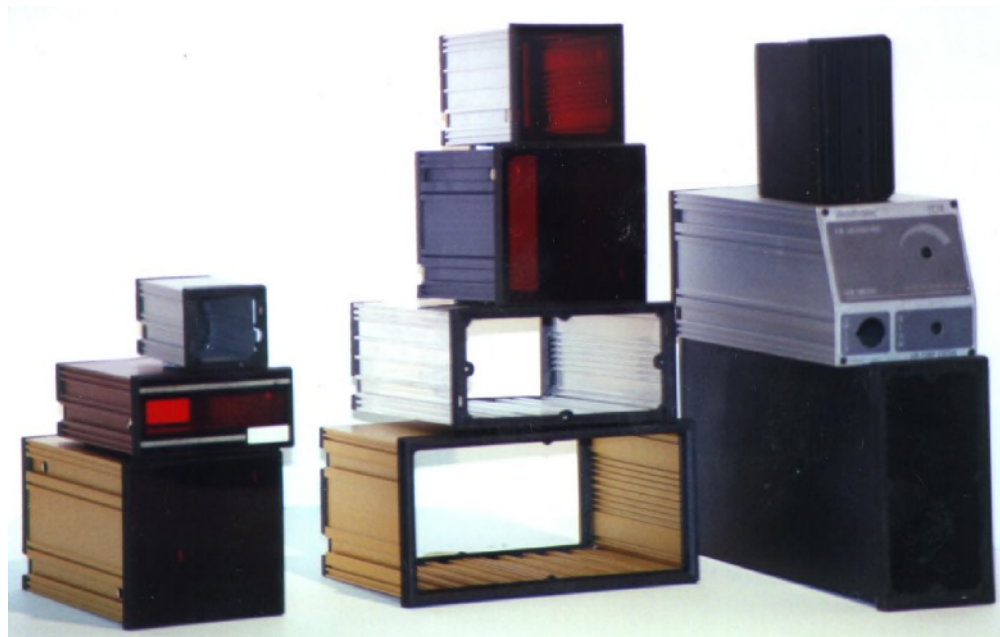

EXAMPLE PHOTO: EXTRUDED PROFILES FOR ELECTRONIC BOARD CONTAINERS  
ANODIZED WITH CUSTOMIZED ALUMINUM PANELS



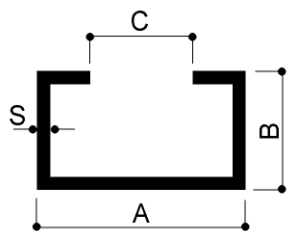

For more dimensions of aluminum C-profiles visit the site:

[www.canalini-alluminio.it](http://www.canalini-alluminio.it)

## "C" PROFILES

PROFILI A "C"	A	B	C	S	GR/MT
	10	4	4	1,1	58
FM2318	11	2,5	6,5	1	45
FM3001	14	3	9,5	0,8	47
FM2341	14	5	4,5	1	80
	14,2	8	6,4	1,2	108
FM2344	14,4	8	6,5	1,1/1,5	102
	15	5	5	1	84
	15	8	5	1,5	142
FM3000	15	14	7	2	234
FM2333	16	6	6	1,5	130
	16	10,5	8	1,5	158
FM2321	16,2	4,7	6	1	85
FM3251	17	14	11,3	2	215
FM2349	18	8	6	1,2	125
FM2339	18	8	7,5	1,5	155
	19,2	10	9,2	1,8	204
FM2326	20	4,5	10	1,3	118
	20	4,6	10	1,3	119
FM2352	20	5	12	1,5	130
FM2335	20	9,5	13,4	1,4	151
	21	9	11	1	122
	21	9	11	1,2	143
FM2328	21	9	11	1,5	120
FM2319	21,5	6	13	1,2/1,6	149
FM2324	21,5	4	13,5	1,2	100
FM2323	21,5	4	16,5	1,5	115
FM2334	21,5	10	9	1,5	216
FM2327	22	6	16	1,2	120
FM2350	22	7,5	12	2	200
FM2331	22	10	11	2,5	280
FM2322	22,2	4	17	1,1	90
FM2329	24,5	17,7	11	1,5	222
	25	4,5	12	1,2	137
	25	5	17	1,5	150
FM2351	25	9	12,9	1,7	218
FM3003	25	9,2	12	1,75	240
	25	9,5	17	1,5	186
	25	10	10	2,5	338
	25,5	10	12	2	275
FM2332	27	5,5	12	1,2	145
FM2348	29,5	12	20,5	1	170
	30	10	10	1	178
FM2340	30	10	10	1,5	260
FM2346	30	10	10	2	330
FM2353	30,2	12,2	16,8	1,6	262
FM2345	34	9,2	21	1,75	280
FM2338	34	10	30	1	145

\* Unless otherwise indicated, profiles are made of EN AW-6060T6 alloy

\* All dimensional measurements are expressed in mm

\* Dimensions, shape and weight are purely indicative



Cataloghi Online: [www.omar-alluminio.it](http://www.omar-alluminio.it)

[www.omar-alluminio.com](http://www.omar-alluminio.com)

CUSTOM ALUMINUM PROFILES / STANDARD / SPECIAL / AND FOR:

ELECTRONICS / LED / PHOTOVOLTAIC / ROBOTIC AUTOMATION / PNEUMATICS / AUTOMOTIVE

Via Newton, n.12

20016 Pero (Milano - Italy)

Tel. +39 02 3535955 r.a. Fax. +39 02 3539929

E-Mail: [info@omar-alluminio.it](mailto:info@omar-alluminio.it)

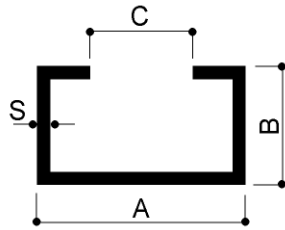

For more dimensions of aluminum C-profiles visit the site:

[www.canalini-alluminio.it](http://www.canalini-alluminio.it)

## "C" PROFILES

PROFILI A "C"	A	B	C	S	GR/MT
	35	13	19	1,5	288
FM3004-1	35	18	15	2	512
FM3004	36	18	22	2	550
FM2336	40	5	30	1,5	215
FM2347	40	8,3	29	2	367
	40	13	20	1,5	324
FM3270	40	15	20	2	340
FM3044	44	13	23,5	2	443
FM2325	45	13	21	2,5	564
	45	8,3	33	2,4	415
FM2343	45	8,3	40,2	2,4/1,5	445
FM3045	45	5,8	35	1,5	257
FM3017	50	15	40	2	626
	54	10,6	42	2	428
FM2342	54	10,6	50	2	435
	55	6,7	49,5	1	189
FM3046	60	30	18	2	832
FM3256	70	30	40	2	~860
FM3254	70	40	60	2	~860
FM3043	90	35	70	3	743
FM3192	120	20	106	2	664
FM3255	147	20	127	2	918
	160	70	4		3876

\* Unless otherwise indicated, profiles are made of EN AW-6060T6 alloy

\* All dimensional measurements are expressed in mm

\* Dimensions, shape and weight are purely indicative

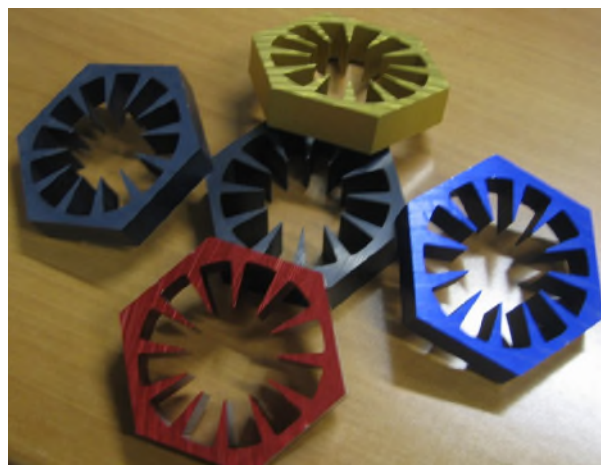

EXAMPLE PHOTO: EXTRUDED ALUMINUM PROFILES CUSTOM ANODIZED

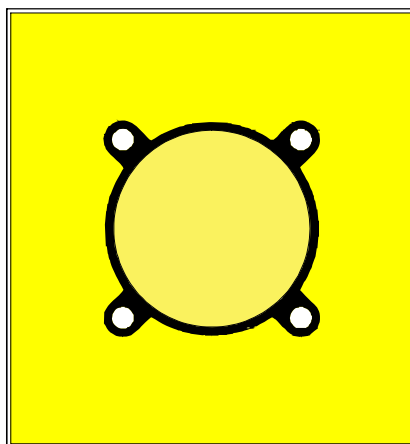

Pdf Catalog Profiles for Pneumatic Cylinders

[www.pneumatica.sm](http://www.pneumatica.sm)

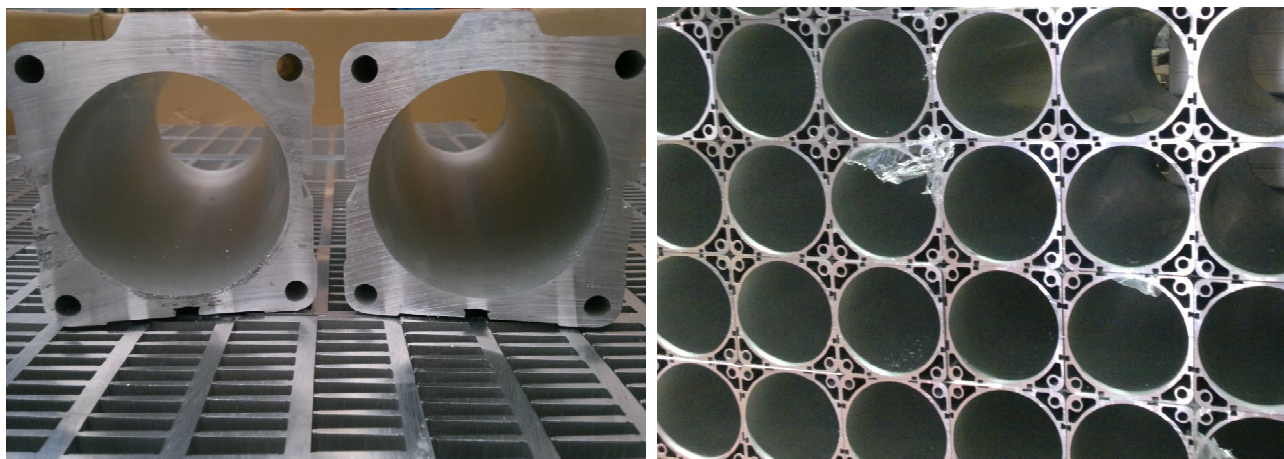

EXAMPLE PHOTO: ALUMINUM PROFILES FOR PNEUMATIC CYLINDERS WITH SPECIAL TECHNICAL CHARACTERISTICS  
HIGH QUALITY PRODUCT: after careful extrusion the profile is subjected to special cold calibration process of the jacket (internal part)  
Thickness of the oxide layer: 20  $\mu$  having hardness 420 HV25

Via Newton, n.12  
20016 Pero (Milano - Italy)  
Tel. +39 02 3535955 r.a. Fax. +39 02 3539929  
E-Mail: [info@omar-alluminio.it](mailto:info@omar-alluminio.it)

Cataloghi Online: [www.omar-alluminio.it](http://www.omar-alluminio.it)  
[www.omar-alluminio.com](http://www.omar-alluminio.com)

CUSTOM ALUMINUM PROFILES / STANDARD / SPECIAL / AND FOR:  
ELECTRONICS / LED / PHOTOVOLTAIC / ROBOTIC AUTOMATION / PNEUMATICS / AUTOMOTIVE



A) flat matrix for open profile

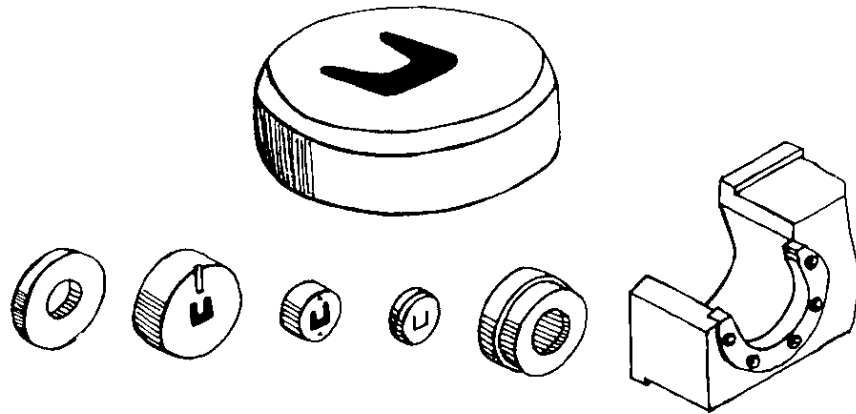

B) Spyder matrix for hollow profile

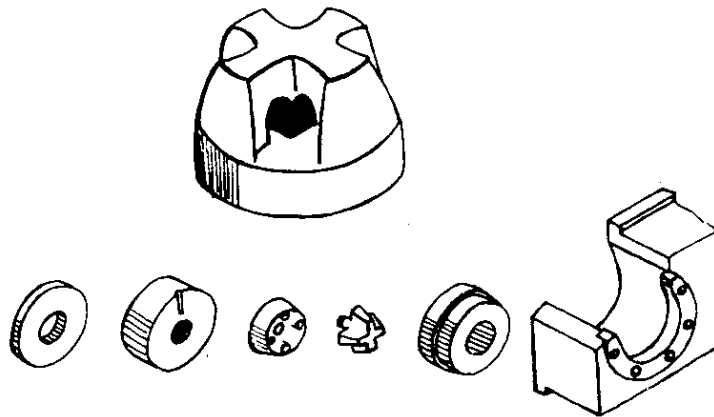

C) Porthole matrix for hollow profile

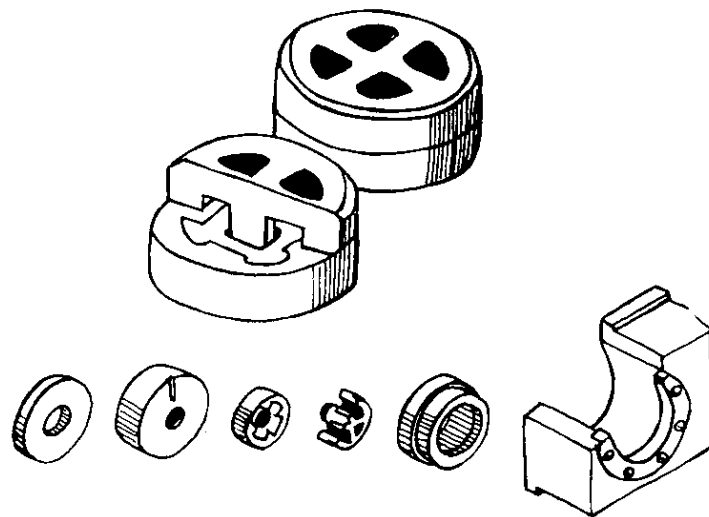

D) Bridge matrix similar to Porthole for hollow profile

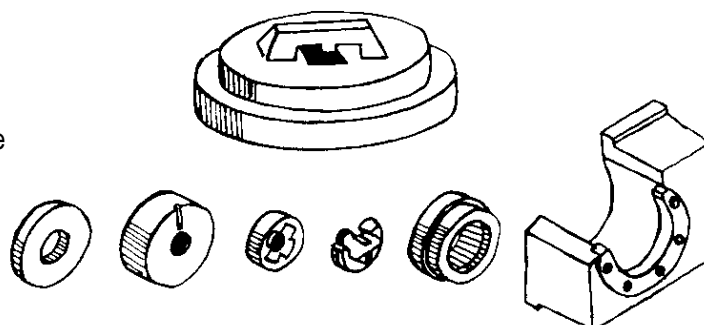

# - MAXIMUM EXTRUDABLE DIMENSIONS -

SCALA 1:3

470

330

R145

R90

PRESSA 3200 TON

PRESSA 6050 TON

Cataloghi Online: [www.omar-alluminio.it](http://www.omar-alluminio.it)

[www.omar-alluminio.com](http://www.omar-alluminio.com)

CUSTOM ALUMINUM PROFILE / STANDARD / SPECIAL / AND FOR:  
450  
630  
ELECTRONICS / LED / PHOTOVOLTAIC / ROBOTIC AUTOMATION / PNEUMATICS / AUTOMOTIVE



Via Newton, n.12  
20016 Pero (Milano - Italy)  
Tel. +39 02 3535955 r.a. Fax. +39 02 3539929  
E-Mail: [info@omar-alluminio.it](mailto:info@omar-alluminio.it)

# Main extrusion alloys

Extrusion aluminium alloy proprieties

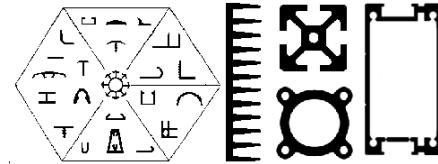

## LEGA DI ALLUMINIO DA ESTRUSIONE EN AW-6060

La lega EN AW 6060 è lega da estrusione più diffusa sul mercato europeo, per le sue doti di alta velocità di deformazione a caldo.

Essa consente la realizzazione di profilati con sezione anche complessa, comprendente cavità e scanalature, per avvicinare quanto più possibile il disegno dell'estruso a quello del manufatto finito, e ridurre al minimo le lavorazioni intermedie.

Essa inoltre presenta ottima resistenza alla corrosione ambientale, anche in atmosfera industriale e marina.

### Caratteristiche fisiche

Massa volumica	2,70	Gr/cm3	Conducibilità termica a 20°C	Nello stato 0: 2,09 W/cm °Kelvin Nello stato T6: 1,75 W/cm °Kelvin
Punto di fusione inferiore	605	C	Coeff. Di dilatazione termica lineare	Tra 20° e 100°C: 23,0 -10-6 1°/Kelvin Tra 20° e 200°C: 24,0 -10-6 1°/Kelvin Tra 20° e 300°C: 25,0 -10-6 1°/Kelvin
Calore specifico tra 0° e 100°C	890	Joule/Kg °Kelvin	Resistività elettrica a 20°C	Nello stato 0: 3,14 microOhm *cm Nello stato T6: 3,25 microOhm *cm
Modulo di elasticità lineare E	69000	Newton/mm2		
Modulo di elasticità tangenziale G	26000	Newton/mm2		

Tipo profilo	(1) stato fisico di fornitura	Diámetro D		Carico	Di rottura a	Carico di	Rottura a	Allungamento					
		o spess. S	[mm] per tonde,					Trazione	Rm [Mpa]	Trazione	Rm [Mpa]	A %	A50 mm%
		o spess. Di parete	e per profili										
tondi e barre piane	T4 (*)	D ≤150	S ≤150	120	-	60	-	16	14				
	T5	D ≤150	S ≤150	160	-	120	-	8	6				
	T6 (*)	D ≤150	S ≤150	190	-	150	-	8	6				
	T64 (*)	D ≤50	S ≤50	180	-	120	-	12	10				
	T66 (*)	D ≤150	S ≤150	215	-	160	-	8	6				
tubi	T4(*)	e ≤15		120	-	60	-	16	14				
	T5	e ≤15		160	-	120	-	8	6				
	T6(*)	e ≤15		190	-	150	-	8	6				
	T64(*)	e ≤15		180	-	120	-	12	10				
	T66(*)	e ≤15		215	-	160	-	8	6				
Profili aperti e cavi	T4 (*)	e ≤25		120	-	60	-	16	14				
	T5	e ≤5		160	-	120	-	8	6				
		5 < e ≤ 25		140	-	100	-	8	6				
	T6 (*)	e ≤3		190	-	150	-	8	6				
		3 < e ≤ 25		170	-	140	-	8	6				
	T64 (*)	e ≤15		180	-	120	-	12	10				
	T66 (*)	e ≤3		215	-	160	-	8	6				
3 < e ≤ 25			195	-	150	-	8	6					

LEGA	Stato fisico	Deformabilità plastica		Lavorabilità su macchina utensile	Saldabilità	Lucidabilità	Ossidazione	anodica		Resistenza alla corrosione		
		a freddo	a caldo					protettiva	decorativa	urbana	industriale	marina
EN AW-3103	F,H 112	2	1	5	3	4	3	3	1	1	2	
	O,H 111	2	1	5	3	4	3	3	1	1	2	
EN AW-6060	O	2	1	5	2	4	1	2	1	2	2	
	T1,T4	3	2	4	2	3	1	1	1	2	2	
	T5,T6	4	X	3	2	2	1	1	1	2	2	
EN AW-6063	O,H 111	2	1	5	2	4	1	2	2	2	3	
	T4	3	2	4	2	3	1	1	2	2	3	
	T5,T6	4	X	3	2	2	1	1	2	2	3	
EN AW-6005A	O	2	1	4	2	3	2	4	2	3	3	
	T4	3	2	3	2	2	2	3	2	3	3	
	T5,T6	4	X	2	2	1	2	3	2	3	3	
EN AW-6082	O,H 111	2	1	4	2	3	2	3	3	3	3	
	T4	3	2	3	2	2	2	2	3	3	3	
	T5,T6	4	X	2	2	1	2	2	3	3	3	

EVALUATION INDEX: 1=EXCELLENT 2=GOOD 3=SUFFICIENT 4=MEDIOCRE 5=POOR X=NOT APPLICABLE TO STATES T5 AND T6



# FIERA MILANO RHO - PERO

MONZA

AUTOSTRADA  
MILANO-TORINO  
TANGENZIALE  
OVEST

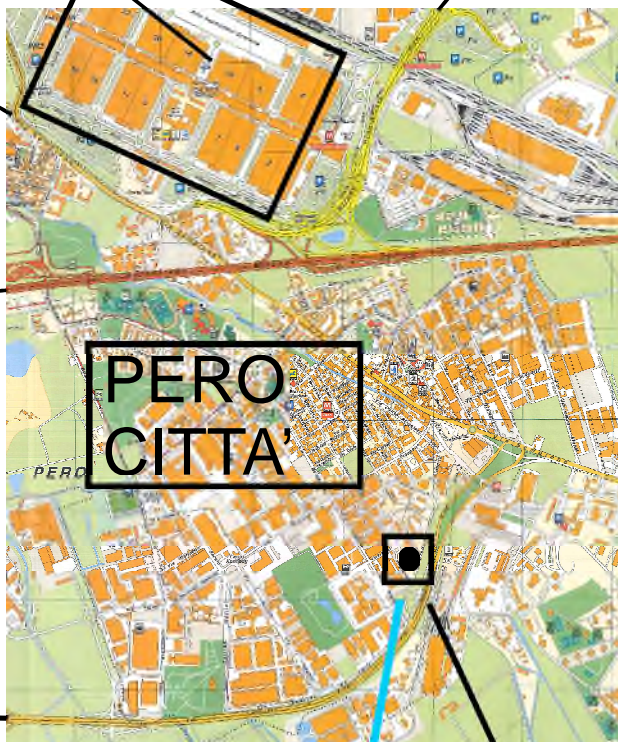

AUTOSTRADA  
MILANO-VENEZIA

MILANO CITTA'  
VIA GALLARATE

TANGENZIALE OVEST

DIREZIONE TORINO  
DIREZIONE GENOVA

USCITA PERO SUD ZONA  
INDUSTRIALE



**OMAR** s.r.l.  
PROFILATI ALLUMINIO  
ALTA TECNOLOGIA

**Via Newton, n.12**  
**20016 Pero (Milano - Italy)**  
**Tel.+39 02 3535955 r.a.**  
**Fax.+39 02 3539929**  
**E.Mail: info@omar-alluminio.it**

Consult our updated catalogue online at:

[www.omar-alluminio.it](http://www.omar-alluminio.it)

[www.omar-alluminio.com](http://www.omar-alluminio.com)

[www.omar-alluminio.eu](http://www.omar-alluminio.eu)

ALUMINUM PROFILES  
CUSTOM-DECORATED-STANDARD-SPECIAL



AND FOR: ELECTRONICS-LED-PHOTOVOLTAIC  
AUTOMATION ROBOTICS-PNEUMATICS-AUTOMOTIVE