

- ° Profilati in alluminio a disegno/standard/speciali
- ° Dissipatori di calore in barre
- ° Dissipatori di calore ad ALTO RENDIMENTO
- ° Dissipatori di calore per LED
- ° Dissipatori di calore lavorati a disegno e anodizzati
- ° Contenitori porta schede per elettronica in alluminio tipo DIN 43700
- ° Profilati strutturali modulari per robotica
- ° Profilati strutturali modulari per impianti FOTOVOLTAICI

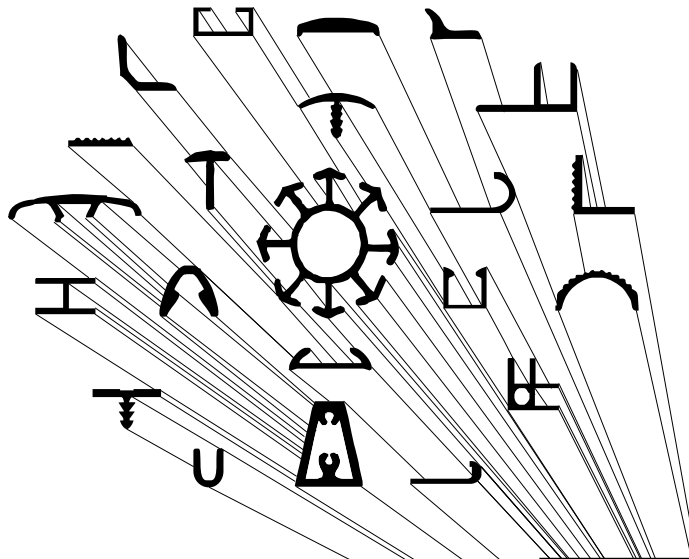

OMAR s.r.l.
PROFILATI ALLUMINIO
ALTA TECNOLOGIA

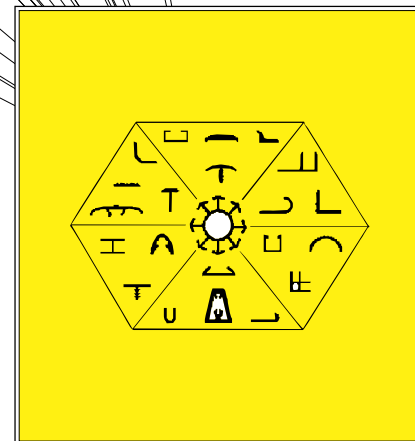

Le "molte forme" della billetta d'alluminio

Profili Speciali Alluminio
 Edizione Settembre 2022

Consultate il catalogo aggiornato online su:
www.omar-alluminio.it
www.omar-alluminio.com
www.omar-alluminio.eu

- ° Profilati per pneumatica
- ° Profilati per stand
- ° Profilati per battiscopa copri fili zoccolini
- ° Prodotti derivati da profili di alluminio
- ° Lavorazione meccanica profili di alluminio



Via Newton, n.12
20016 Pero (Milano - Italy)
Tel.+39 02 3535955 r.a.
Fax.+39 02 3539929
E.Mail: info@omar-alluminio.it

PROFILATI IN ALLUMINIO
 A DISEGNO-STANDARD-SPECIALI



ED: ELETTRONICA-LED-FOTOVOLTAICO
 AUTOMAZIONE-ROBOTICA-PNEUMATICA-AUTOMOTIVE

Profili Speciali - Aluminium profile custom sections

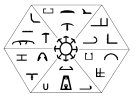

DISEGNI AL VERO (1:1)- SCALE 1:1

Cataloghi Online: www.omar-alluminio.it

www.omar-alluminio.com

PROFILATI ALLUMINIO A DISEGNO / STANDARD / SPECIALI / E PER:

ELETTRONICA / LED / FOTOVOLTAICO / AUTOMAZIONE ROBOTICA / PNEUMATICA / AUTOMOTIVE

Via Newton, n.12

20016 Pero (Milano - Italy)

Tel. +39 02 3535955 r.a. Fax. +39 02 3539929

E-Mail: info@omar-alluminio.it

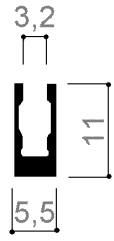

1303

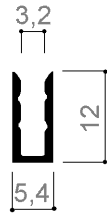

1300



1306



1333



1312

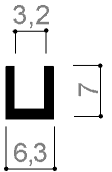

1315

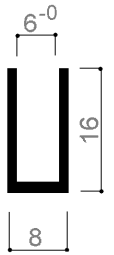

1326

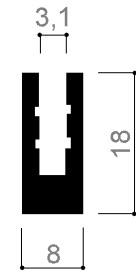

1309



1322



1324



1313

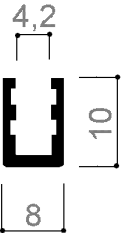

1302
OX ORO

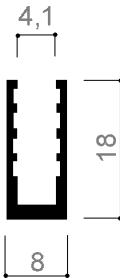

1321

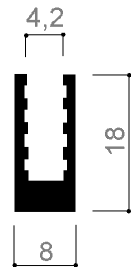

1308



1338

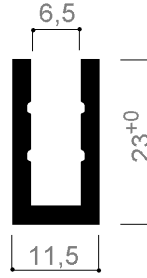

1325

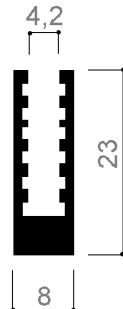

1323

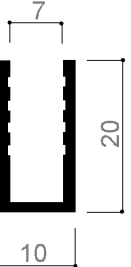

1329

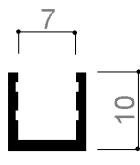

1328

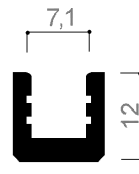

1330

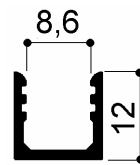

2048*

*PROFILO RISERVATO

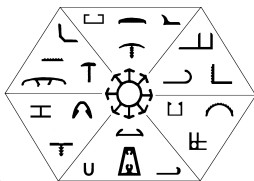

ANCHE PER MODESTE QUANTITA' SI POSSONO FORNIRE
PREVIO ALLESTIMENTO MATRICE, ULTERIORI PROFILI
SECONDO LE VS. SPECIFICHE

AGGIORNAMENTO CONTINUO - ED. DEL 09-2022

Profili in alluminio e scorrevoli per vetrinette



DISEGNI AL VERO (1:1)

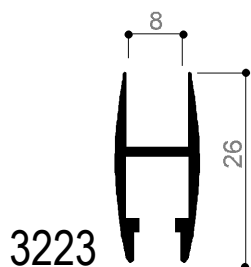

3223

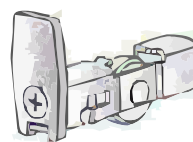
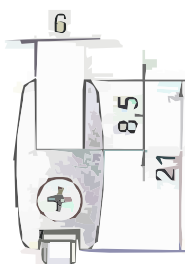

1621/D

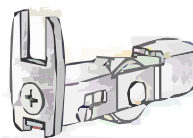

1621/D/F

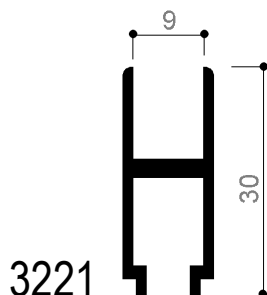

3221

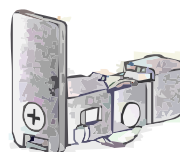
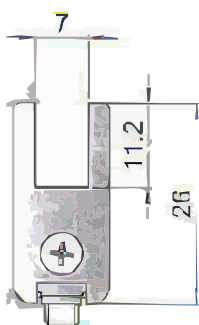
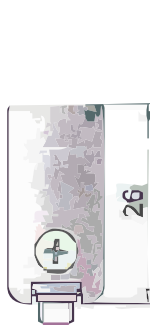

1824/N

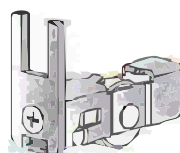

1824/N/F



3162

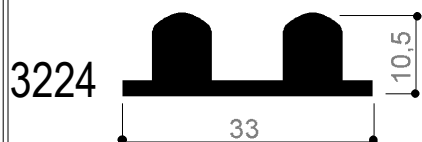

3224



3225

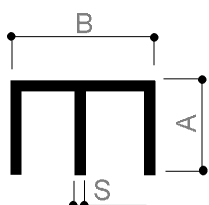

A x B x S
20x15x1
20x18x1,2
20x20x1

3222

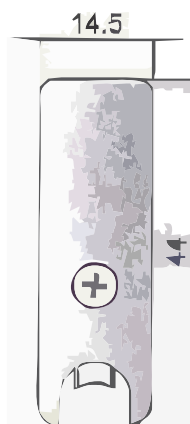
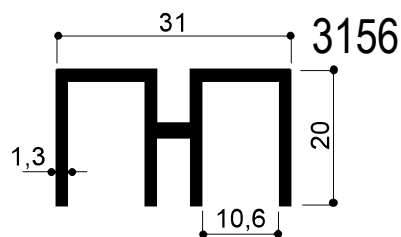
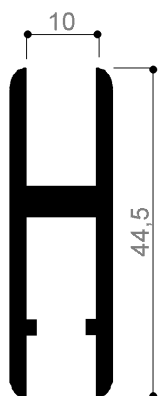

140-03



FOTO DI ESEMPIO: DISSIPATORE
CON ALETTATURA MICRO PER
ILLUMINAZIONE A LED

Via Newton, n.12
20016 Pero (Milano - Italy)
Tel. +39 02 3535955 r.a. Fax. +39 02 3539929
E-Mail: info@omar-alluminio.it

Cataloghi Online: www.omar-alluminio.it
www.omar-alluminio.com

PROFILATI ALLUMINIO A DISEGNO / STANDARD / SPECIALI / E PER:
ELETTRONICA / LED / FOTOVOLTAICO / AUTOMAZIONE ROBOTICA / PNEUMATICA / AUTOMOTIVE

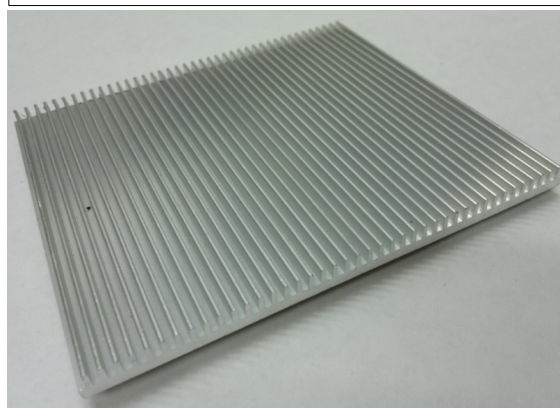

Profili Speciali - Aluminium profile custom sections

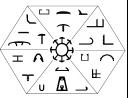

DISEGNI AL VERO (1:1)- SCALE 1:1

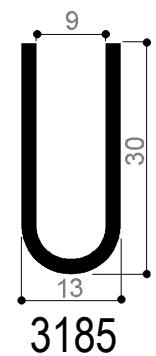
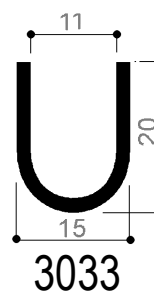
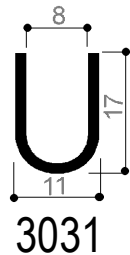
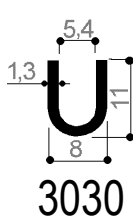
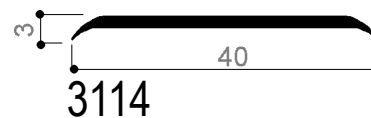
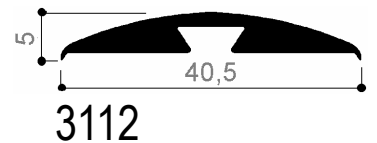
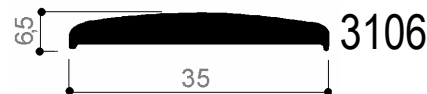
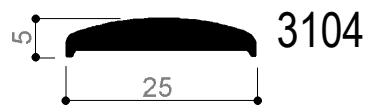
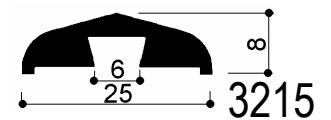
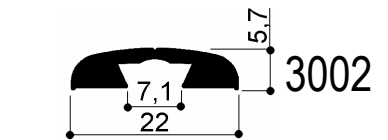
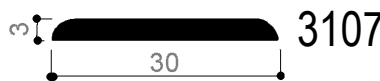
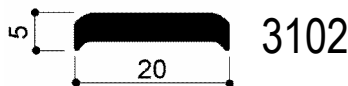
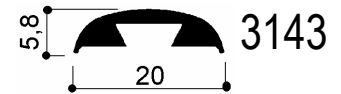
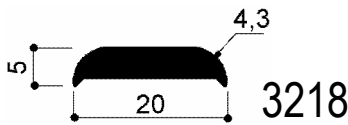
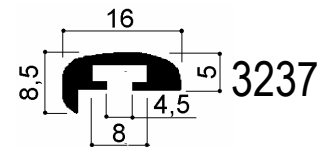
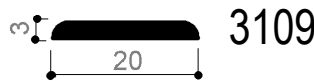
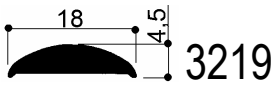
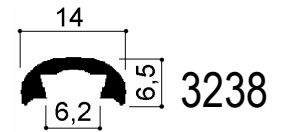
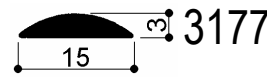
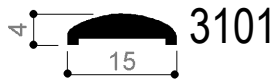
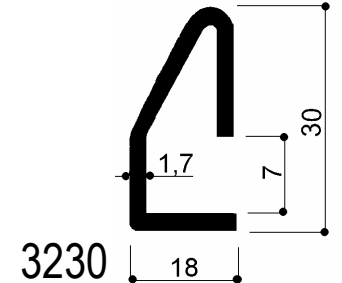
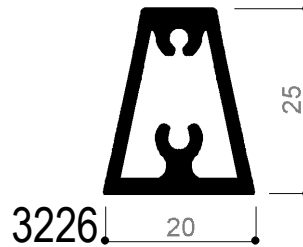
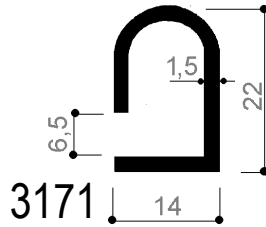
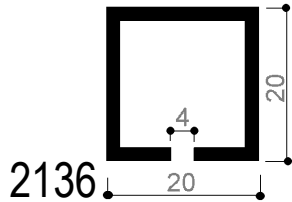
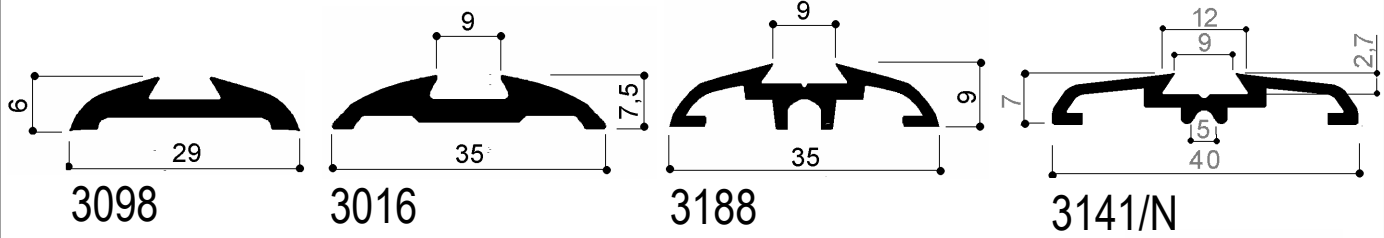

Profili Speciali - Aluminium profile custom sections

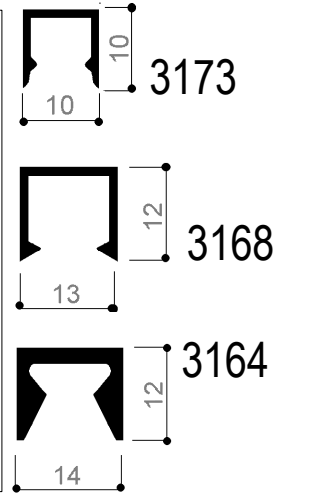
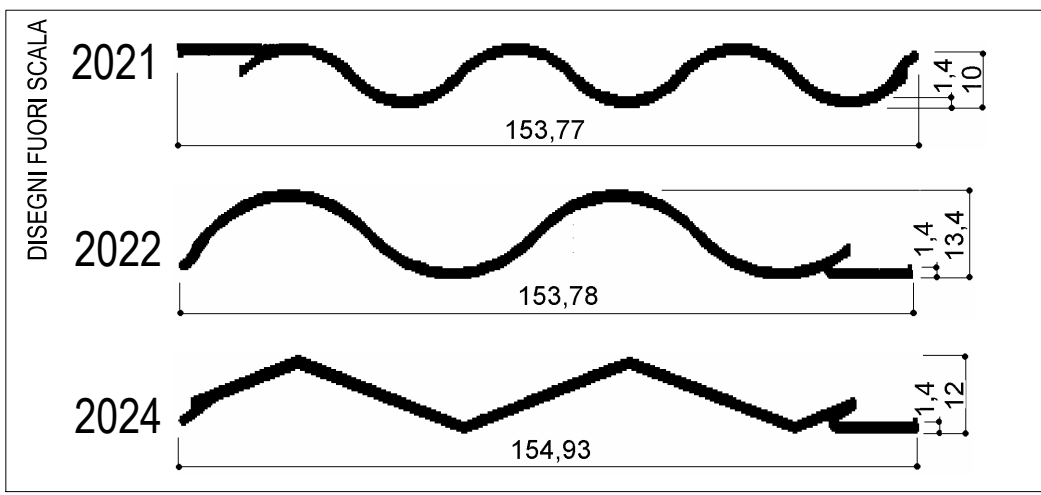
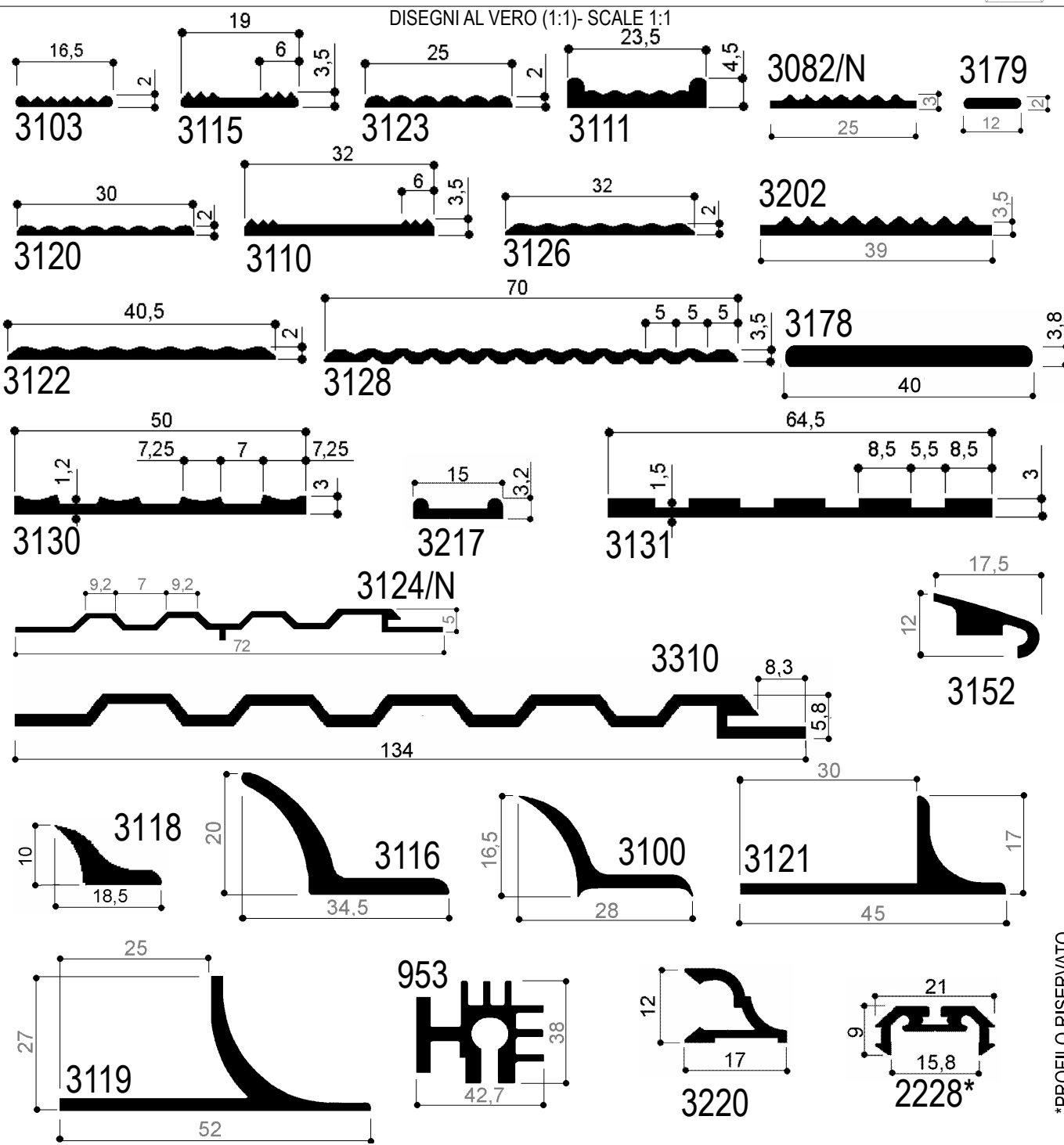

*PROFILO RISERVATO

Via Newton, n.12
20016 Pero (Milano - Italy)
Tel. +39 02 3535955 r.a. Fax. +39 02 3539929
E-Mail: info@omar-alluminio.it

Cataloghi Online: www.omar-alluminio.it
www.omar-alluminio.com

PROFILATI ALLUMINIO A DISEGNO / STANDARD / SPECIALI / E PER:
ELETTRONICA / LED / FOTOVOLTAICO / AUTOMAZIONE ROBOTICA / PNEUMATICA / AUTOMOTIVE



Profili Speciali - Aluminium profile custom sections

DISEGNI AL VERO (1:1)

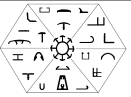

Cataloghi Online: www.omar-alluminio.it
www.omar-alluminio.com

Via Newton, n.12
 20016 Pero (Milano - Italy)
 Tel. +39 02 3535955 r.a. Fax. +39 02 3539929
 E-Mail: info@omar-alluminio.it

PROFILATI ALLUMINIO A DISEGNO / STANDARD / SPECIALI / E PER:
 ELETTRONICA / LED / FOTOVOLTAICO / AUTOMAZIONE ROBOTICA / PNEUMATICA / AUTOMOTIVE

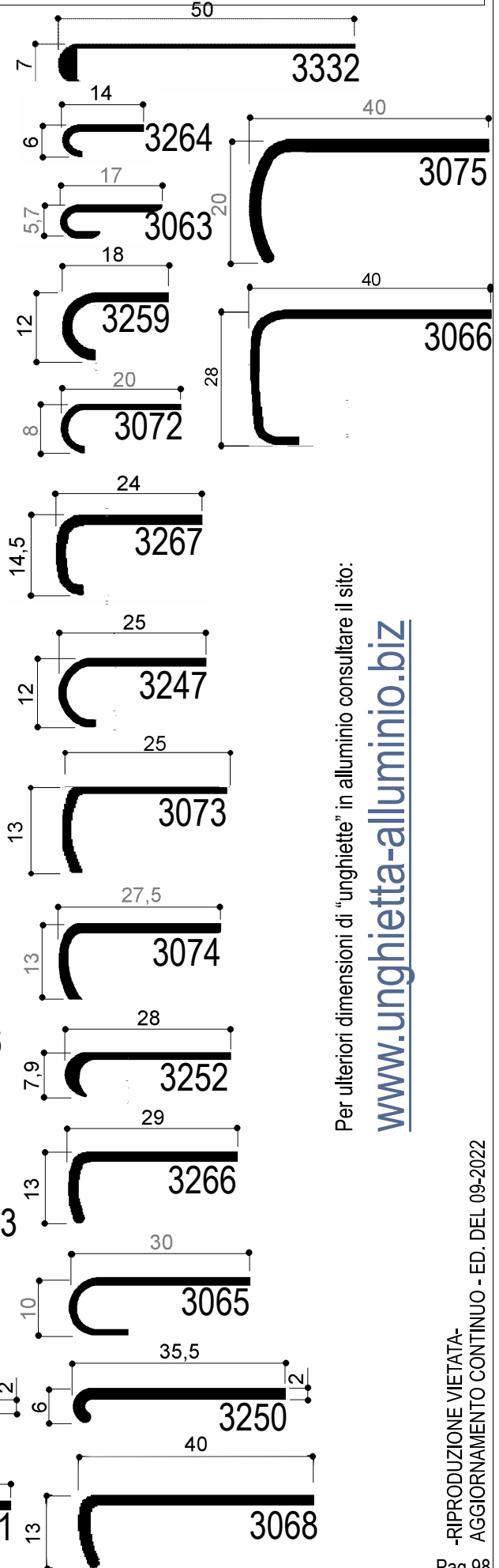
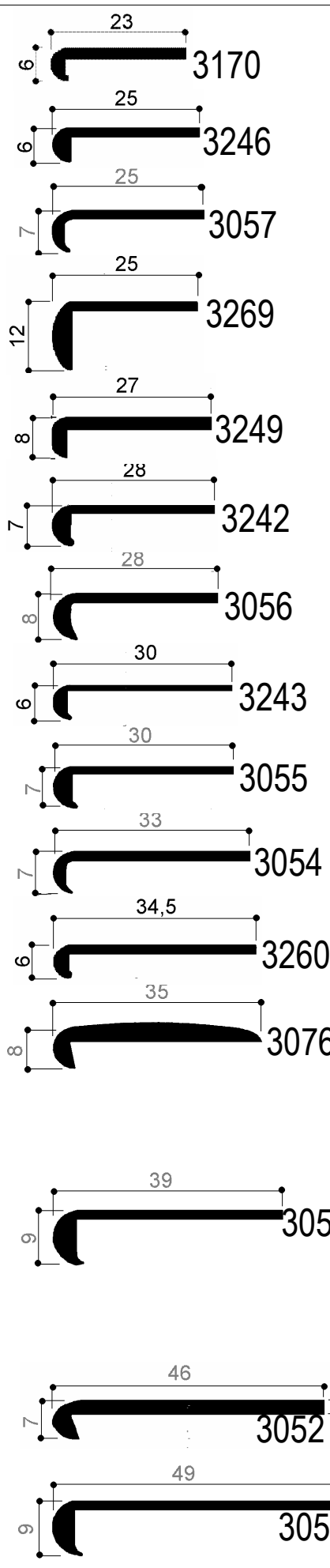
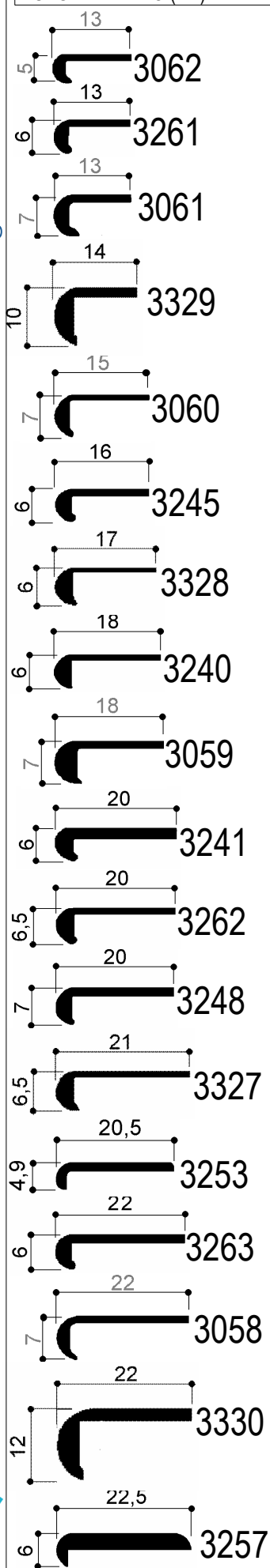

Per ulteriori dimensioni di "unghiette" in alluminio consultare il sito:

www.unghietta-alluminio.biz



Profili Speciali - Aluminium profile custom sections



DISEGNI AL VERO (1:1) - SCALE 1:1

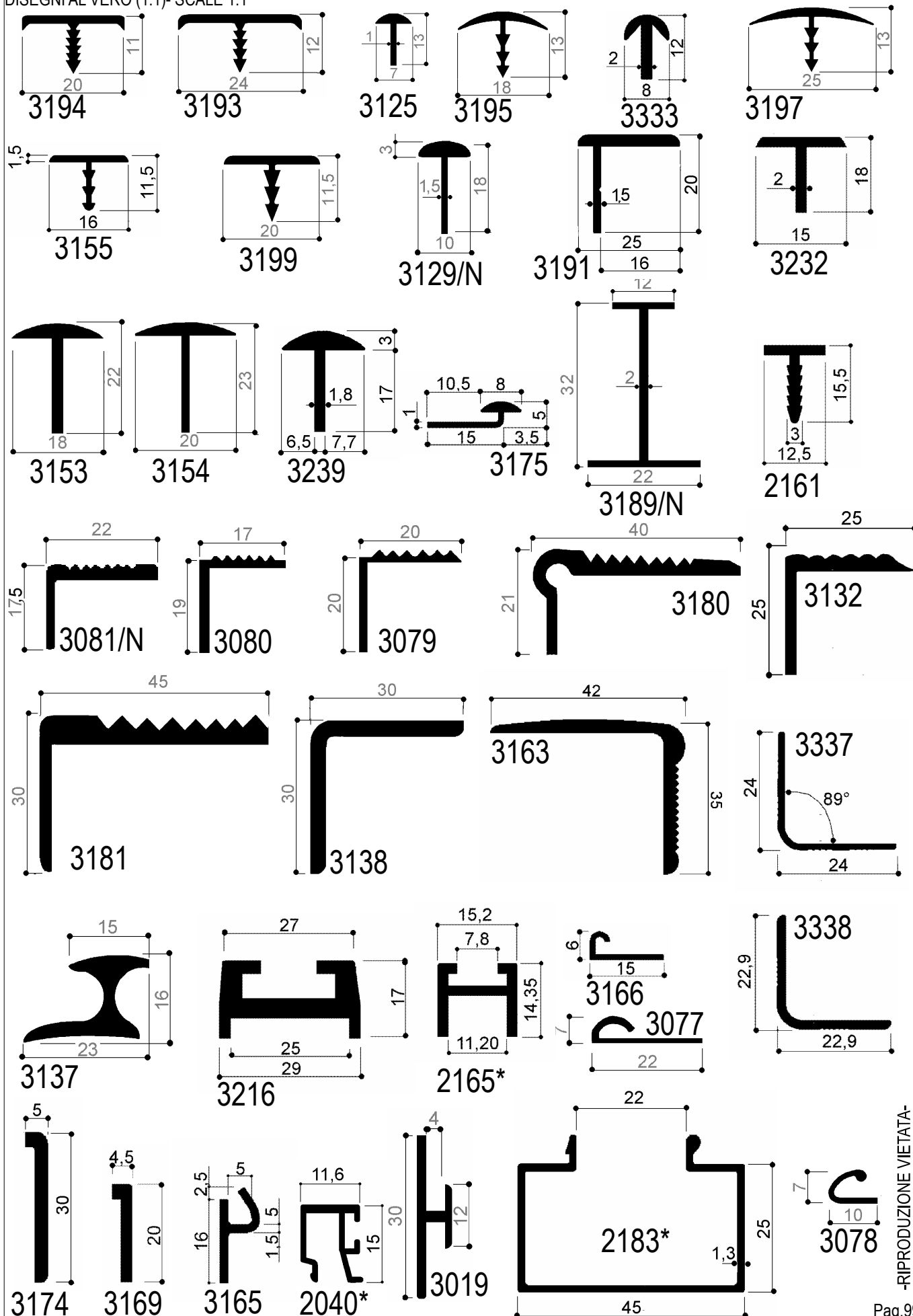

Via Newton, n.12
20016 Pero (Milano - Italy)
Tel. +39 02 3535955 r.a. Fax. +39 02 3535929
E-Mail: info@omar-alluminio.it

Cataloghi Online: www.omar-alluminio.it
www.omar-alluminio.com

PROFILATI ALLUMINIO A DISEGNO / STANDARD / SPECIALI / E PER:
ELETTRONICA / LED / FOTOVOLTAICO / AUTOMAZIONE ROBOTICA / PNEUMATICA / AUTOMOTIVE

-RIPRODUZIONE VIETATA-
AGGIORNAMENTO CONTINUO - ED. DEL 09-2022
Pag.99



Profili Speciali - Aluminium profile custom sections



Via Newton, n.12
20016 Pero (Milano - Italy)
Tel. +39 02 3535955 r.a. Fax. +39 02 3539929
E-Mail: info@omar-alluminio.it

Cataloghi Online: www.omar-alluminio.it
www.omar-alluminio.com
PROFILATI ALLUMINIO A DISEGNO / STANDARD / SPECIALI / E PER:
ELETTRONICA / LED / FOTOVOLTAICO / AUTOMAZIONE ROBOTICA / PNEUMATICA / AUTOMOTIVE

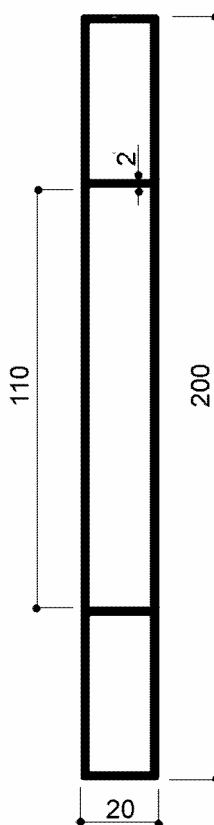

TR200X20/S

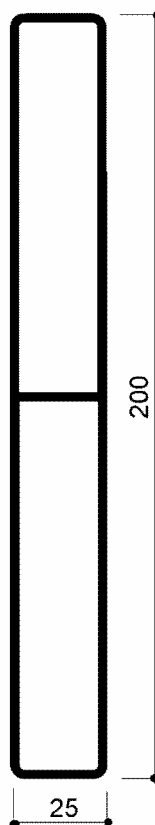

TR200X25/S

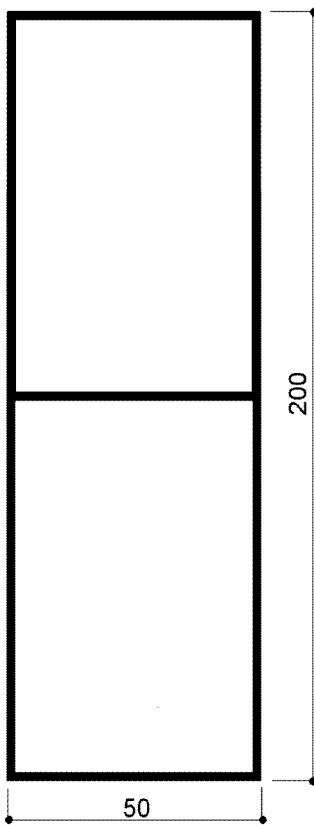

TR200X50/S

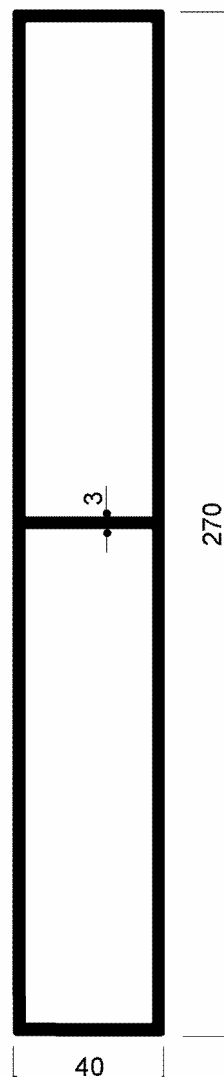

TR270X40/S

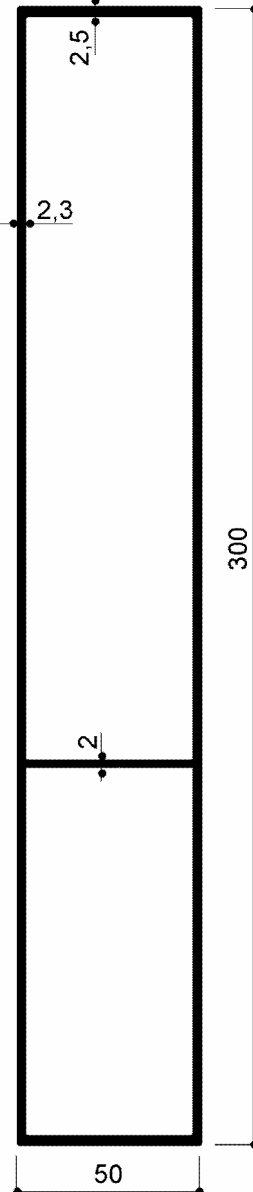

TR300X50/S

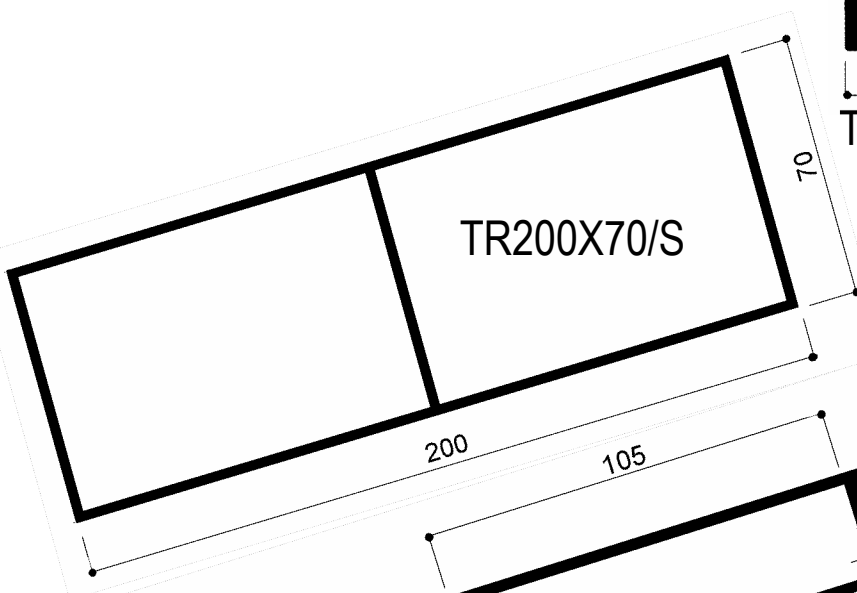

TR200X70/S

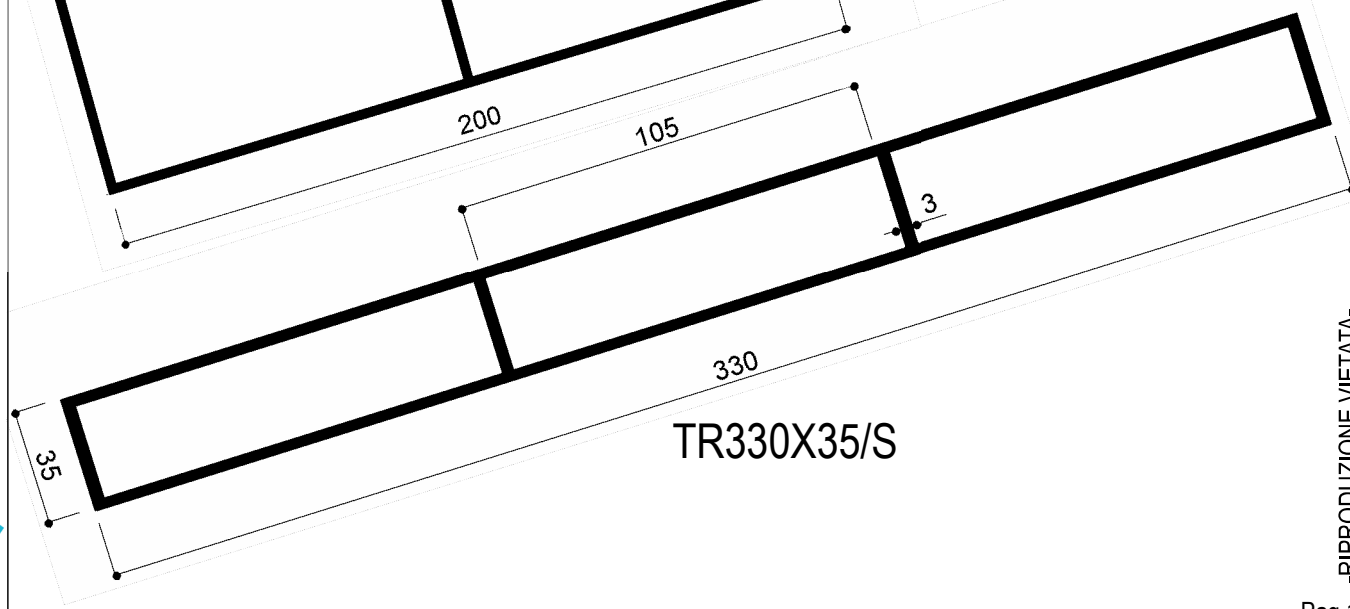

TR330X35/S

Profili Speciali - Aluminium profile custom sections

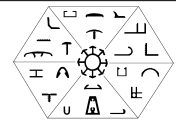

DISEGNI AL VERO (1:1)- SCALE 1:1

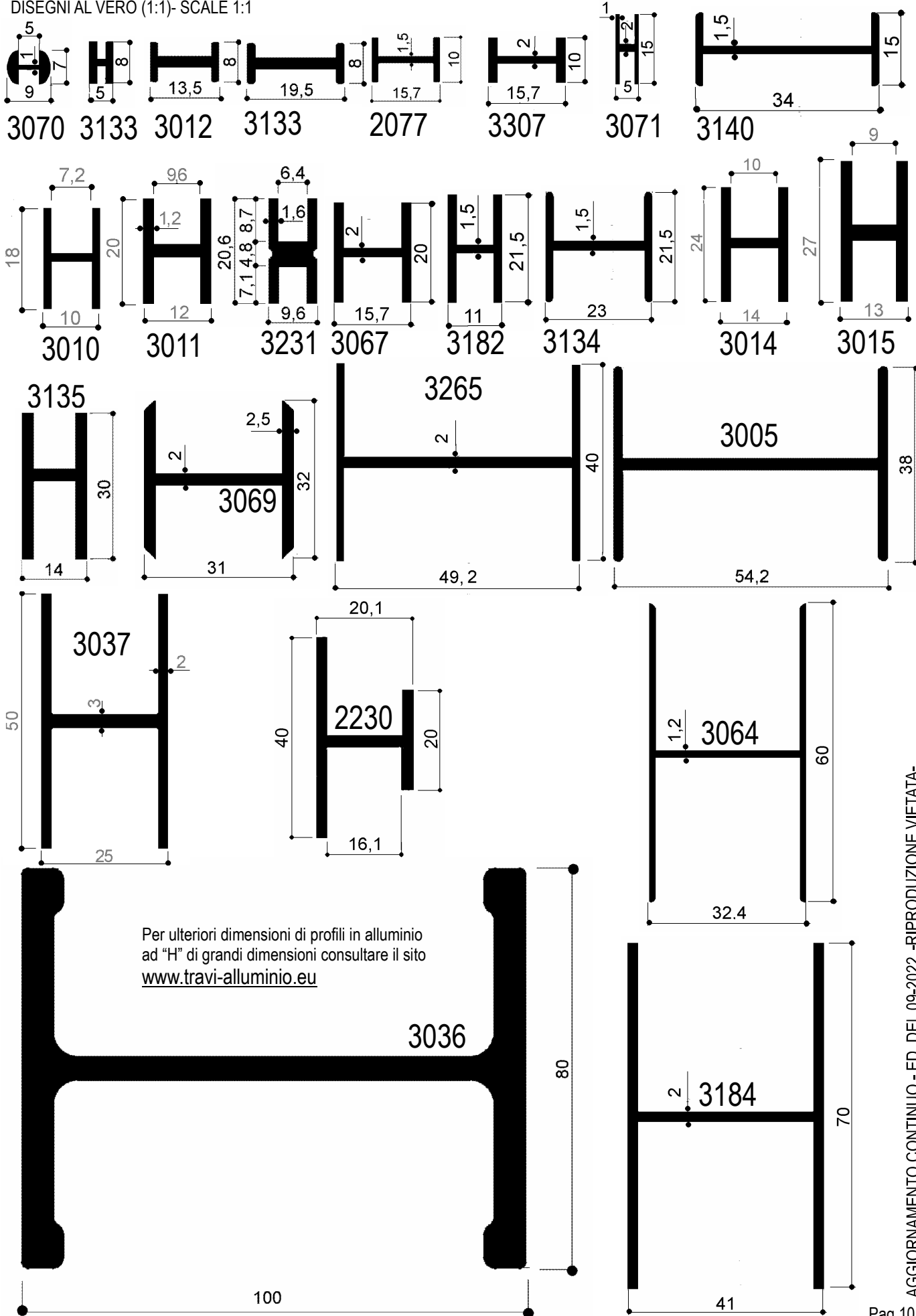

Per ulteriori dimensioni di profili in alluminio ad "H" di grandi dimensioni consultare il sito www.travi-alluminio.eu

Via Newton, n.12
20016 Pero (Milano - Italy)
Tel.+39 02 3535955 r.a. Fax.+39 02 3539929
E.Mail: info@omar-alluminio.it

Cataloghi Online: www.omar-alluminio.it
www.omar-alluminio.com

PROFILATI ALLUMINIO A DISEGNO / STANDARD / SPECIALI / E PER:
ELETTRONICA / LED / FOTOVOLTAICO / AUTOMAZIONE ROBOTICA / PNEUMATICA / AUTOMOTIVE

AGGIORNAMENTO CONTINUO - ED. DEL 09-2022 - RIPRODUZIONE VIETATA-



Profili Speciali - Aluminium profile custom sections



DISEGNI AL VERO (1:1) - SCALE 1:1

Via Newton, n.12
20016 Pero (Milano - Italy)
Tel. +39 02 3535955 r.a. Fax. +39 02 3539929
E-Mail: info@omar-alluminio.it

Cataloghi Online: www.omar-alluminio.it
www.omar-alluminio.com

PROFILATI ALLUMINIO A DISEGNO / STANDARD / SPECIALI / E PER:
ELETTRONICA / LED / FOTOVOLTAICO / AUTOMAZIONE ROBOTICA / PNEUMATICA / AUTOMOTIVE

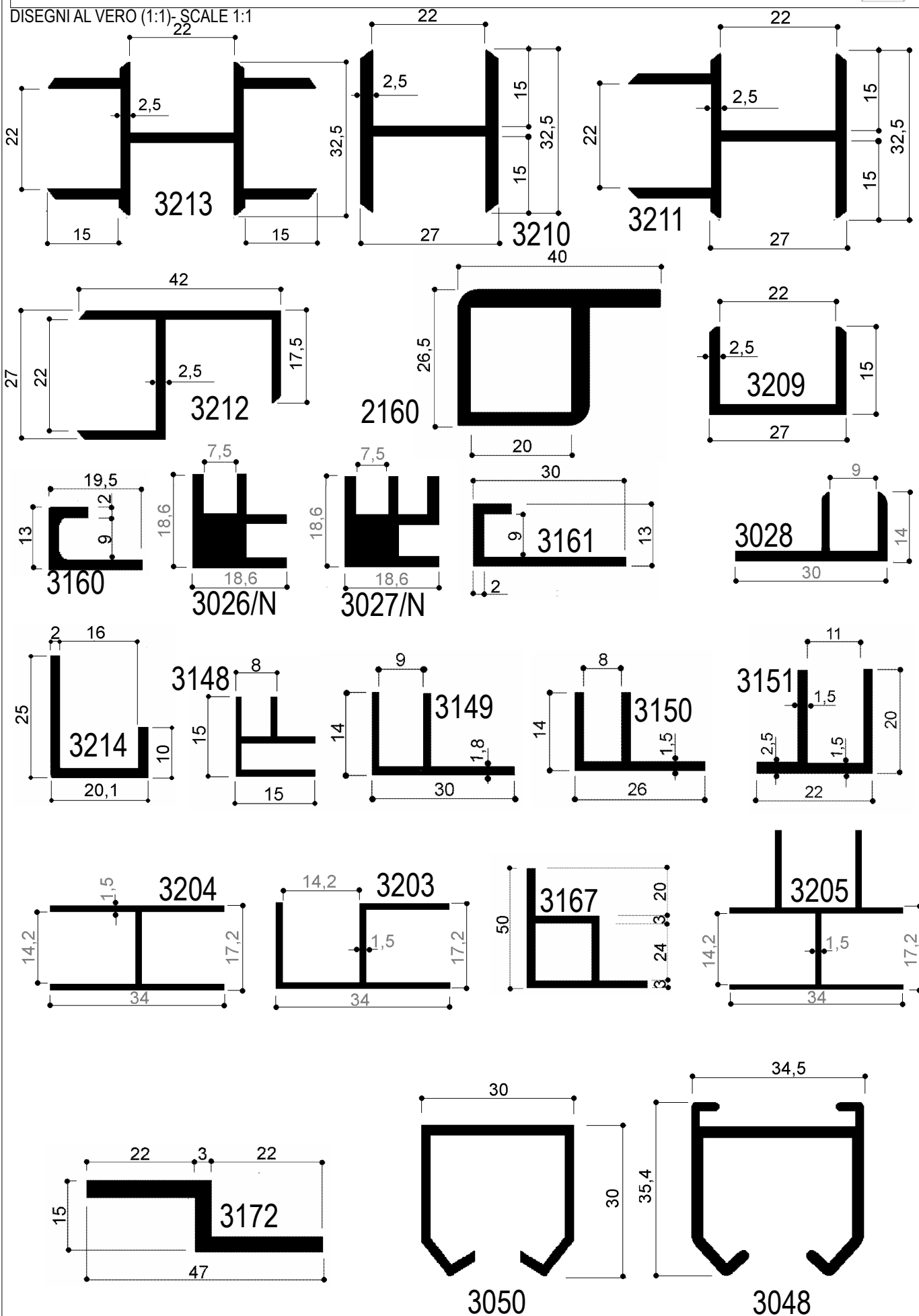



DISEGNI AL VERO (1:1)

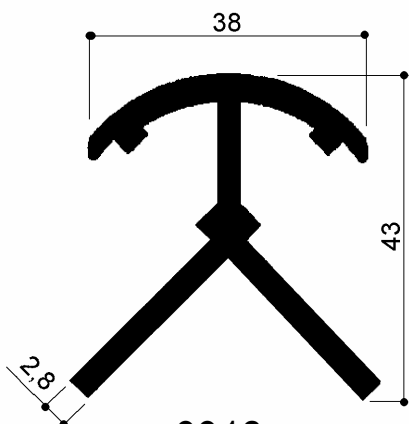

3312

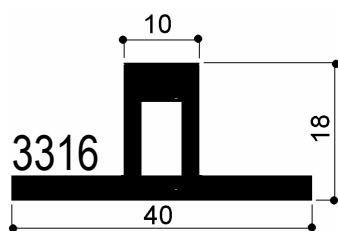

3316

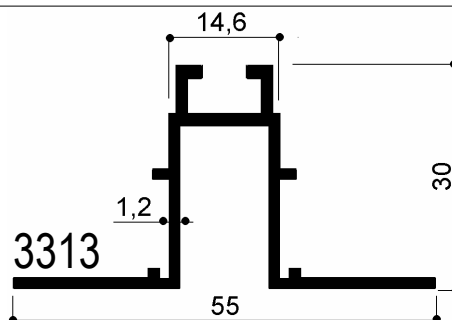

3313

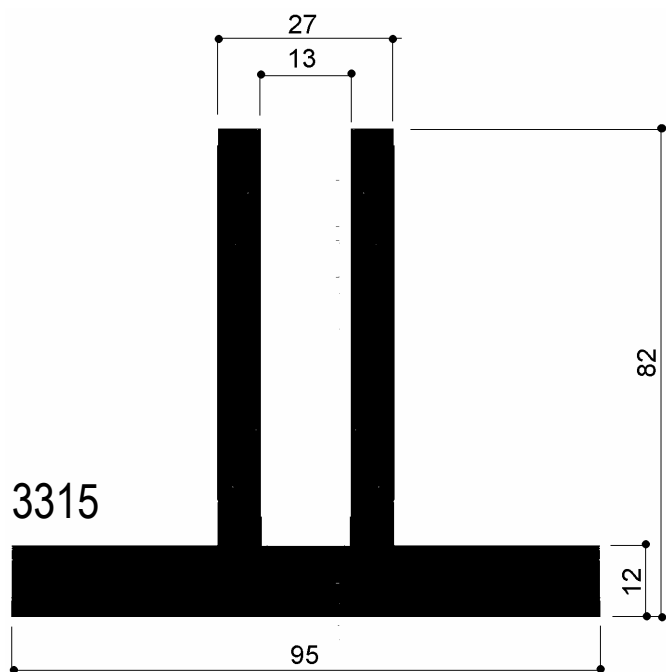

3315

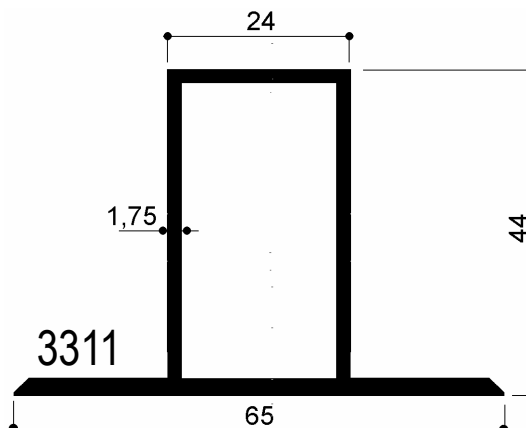

3311

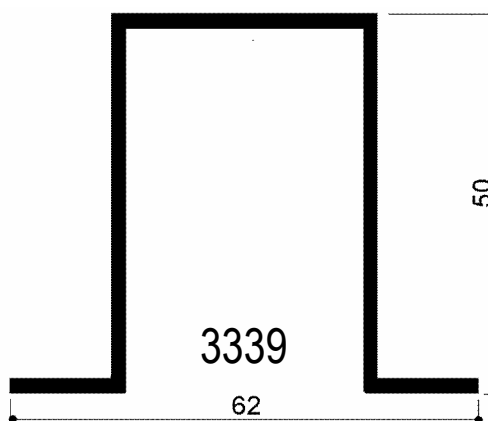

3339

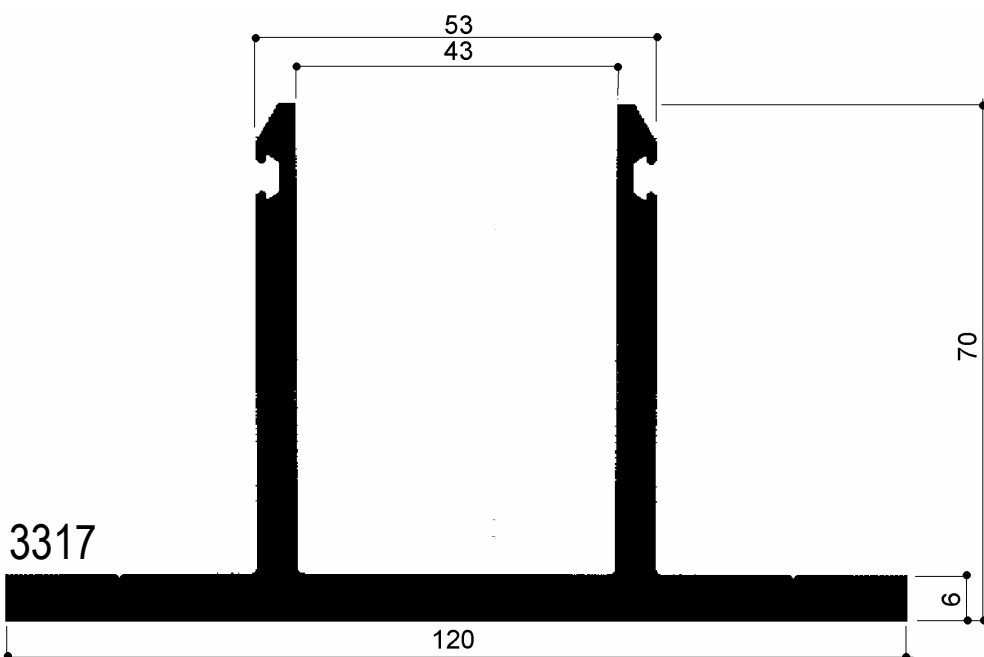

3317

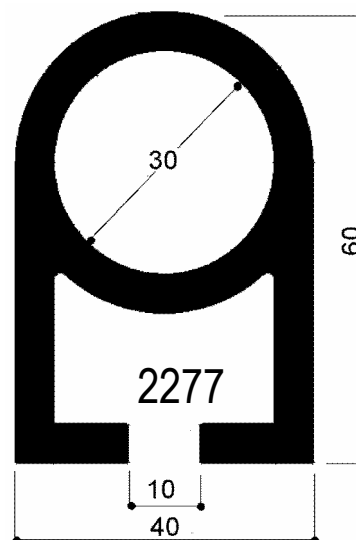

2277

Via Newton, n.12
20016 Pero (Milano - Italy)
Tel.+39 02 3535955 r.a. Fax.+39 02 3539929
E-Mail: info@omar-alluminio.it

Cataloghi Online: www.omar-alluminio.it
www.omar-alluminio.com

PROFILATI ALLUMINIO A DISEGNO / STANDARD / SPECIALI / E PER:

ELETTRONICA / LED / FOTOVOLTAICO / AUTOMAZIONE ROBOTICA / PNEUMATICA / AUTOMOTIVE



Profili Speciali - Aluminium profile custom sections

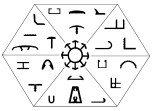

Cataloghi Online: www.omar-alluminio.it

www.omar-alluminio.com

PROFILATI ALLUMINIO A DISEGNO / STANDARD / SPECIALI / E PER:

ELETTRONICA / LED / FOTOVOLTAICO / AUTOMAZIONE ROBOTICA / PNEUMATICA / AUTOMOTIVE

Via Newton, n.12

20016 Pero (Milano - Italy)

Tel. +39 02 3535955 r.a. Fax. +39 02 3539929

E-Mail: info@omar-alluminio.it

DISEGNI AL VERO (1:1)

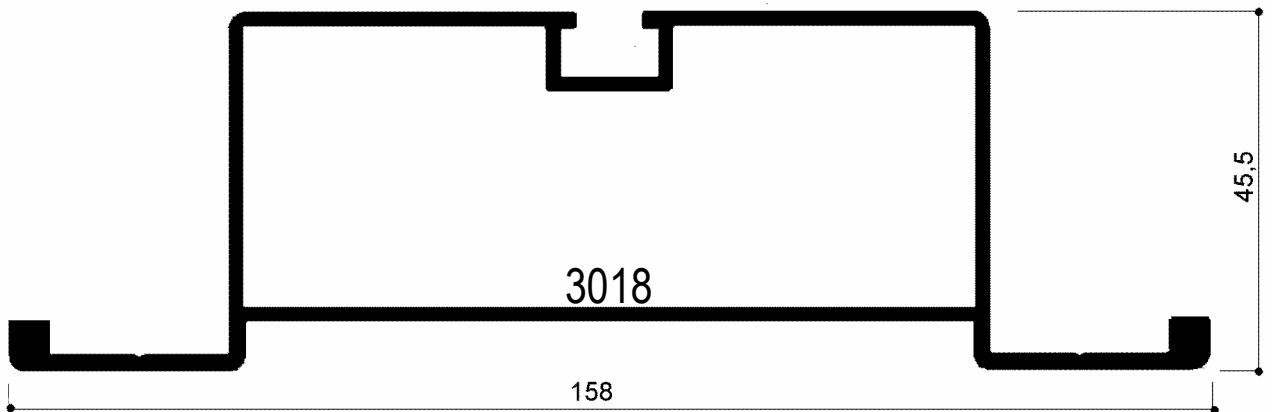
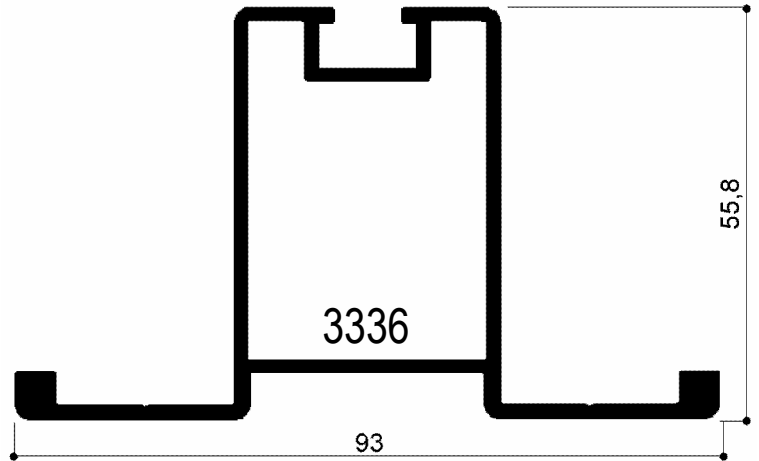
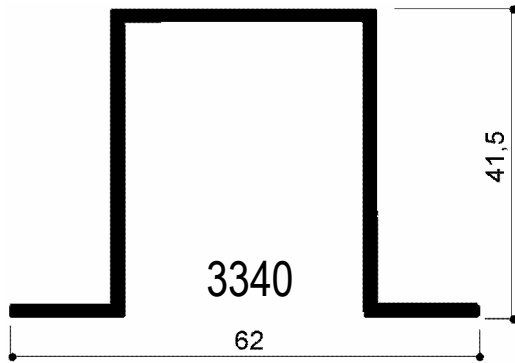
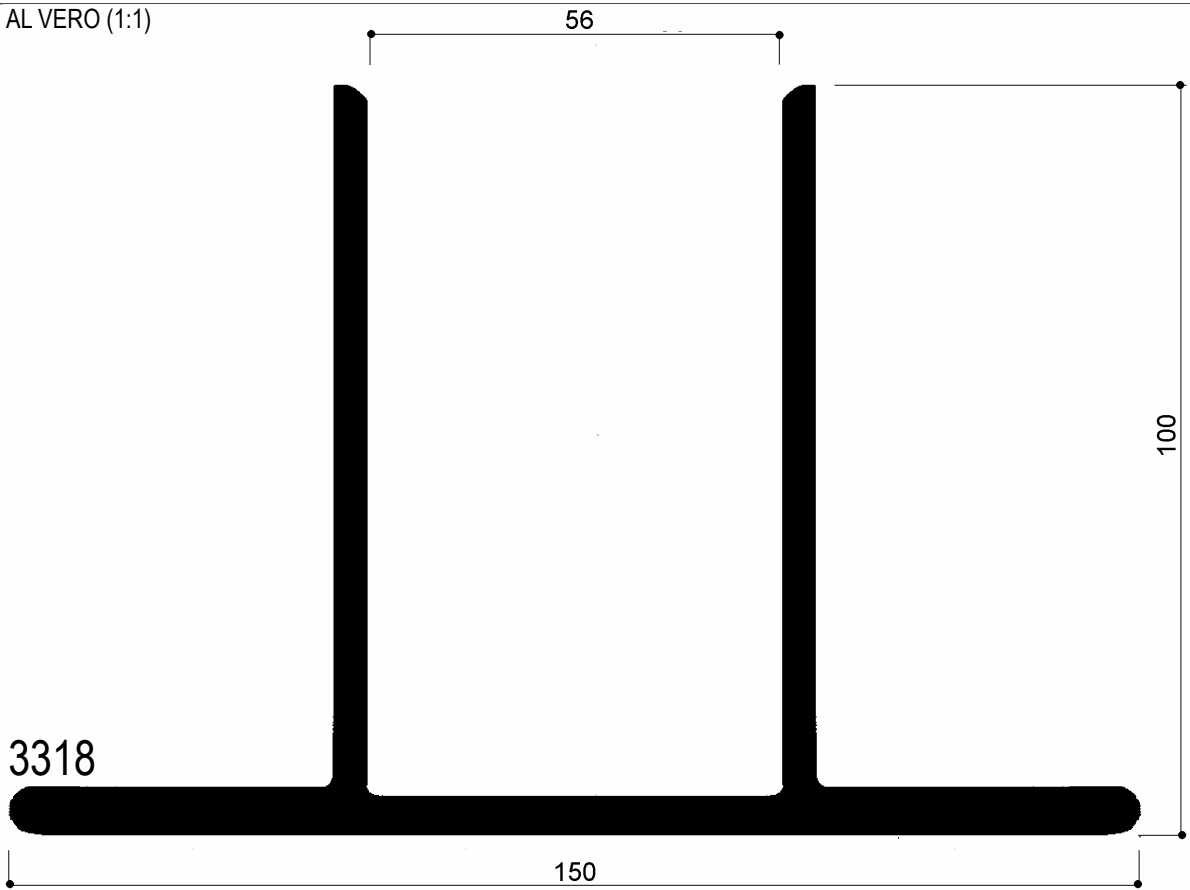

Profili Speciali - Aluminium profile custom sections



DISEGNI AL VERO (1:1)- SCALE 1:1

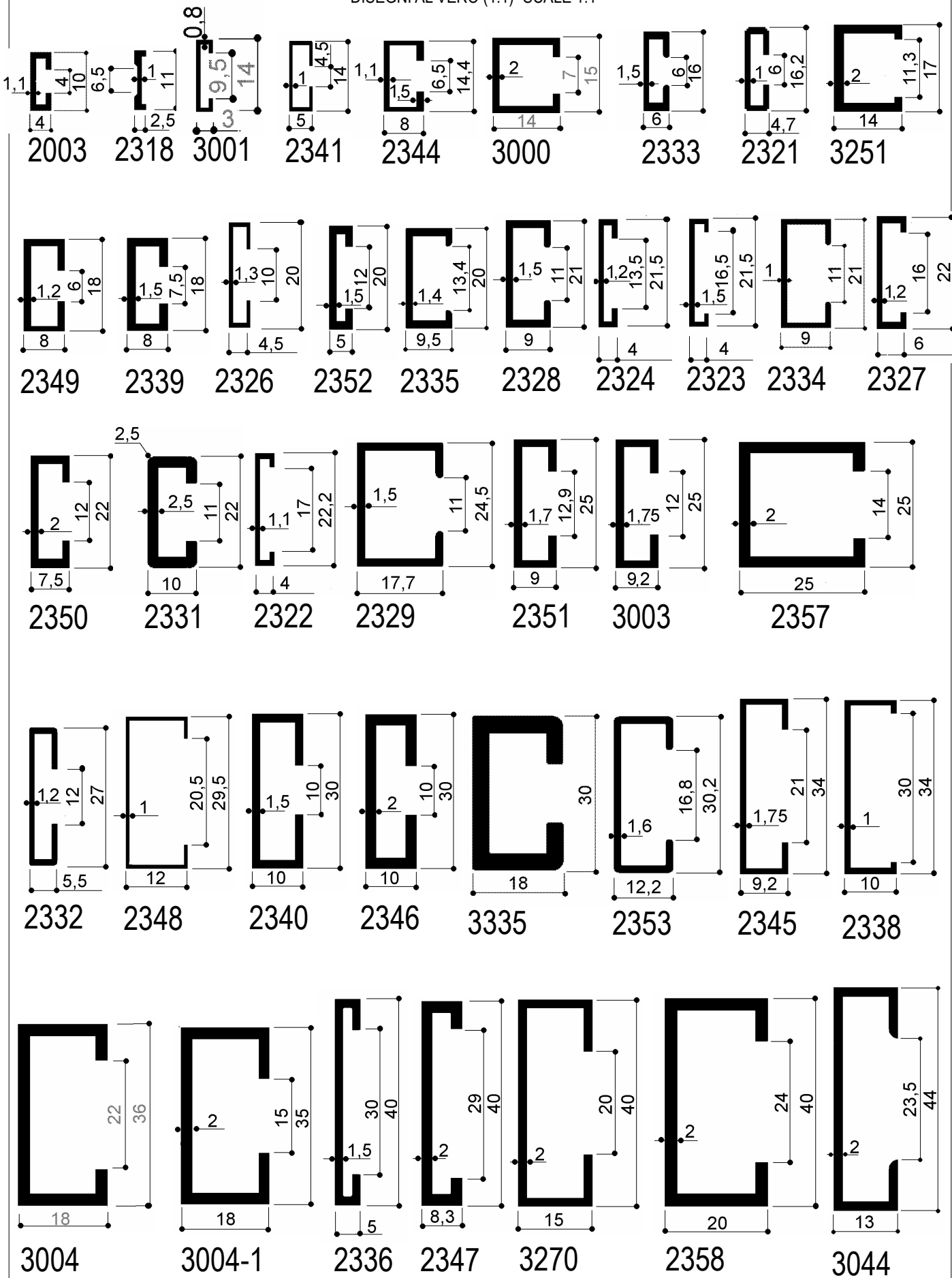

Via Newton, n.12

20016 Pero (Milano - Italy)

Tel. +39 02 3535955 r.a. Fax. +39 02 3539929

E-Mail: info@omar-alluminio.it

Cataloghi Online: www.omar-alluminio.it

www.omar-alluminio.com

PROFILATI ALLUMINIO A DISEGNO / STANDARD / SPECIALI / E PER:

ELETTRONICA / LED / FOTOVOLTAICO / AUTOMAZIONE ROBOTICA / PNEUMATICA / AUTOMOTIVE



Per ulteriori dimensioni di profili a C in alluminio consultare il sito: www.canalini-alluminio.it

-RIPRODUZIONE VIETATA-

AGGIORNAMENTO CONTINUO - ED. DEL 09-2022

Profili Speciali - Aluminium profile custom sections

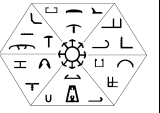

DISEGNI AL VERO (1:1)

Via Newton, n.12

20016 Pero (Milano - Italy)

Tel. +39 02 3535955 r.a. Fax. +39 02 3539929

E-Mail: info@omar-alluminio.it

Cataloghi Online: www.omar-alluminio.it

www.omar-alluminio.com

PROFILATI ALLUMINIO A DISEGNO / STANDARD / SPECIALI / E PER:

ELETTRONICA / LED / FOTOVOLTAICO / AUTOMAZIONE ROBOTICA / PNEUMATICA / AUTOMOTIVE

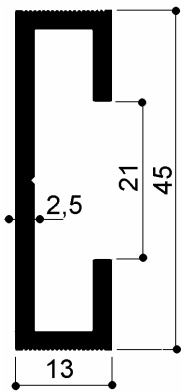

2325*

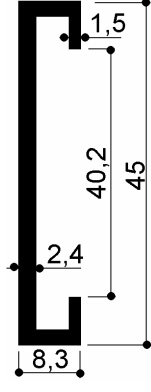

2343

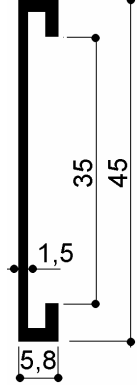

3045

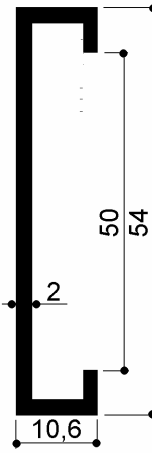

2342

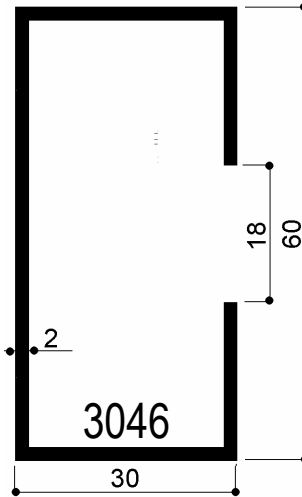

3046

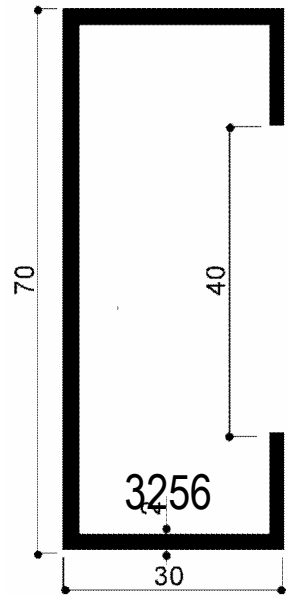

3256

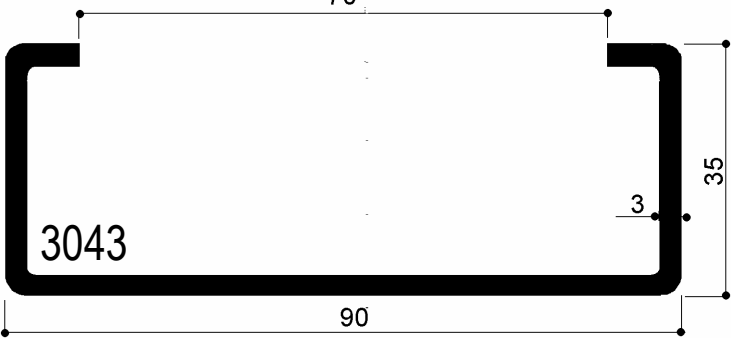

3043

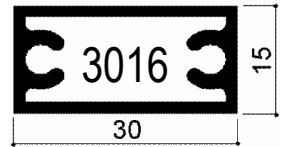

3016

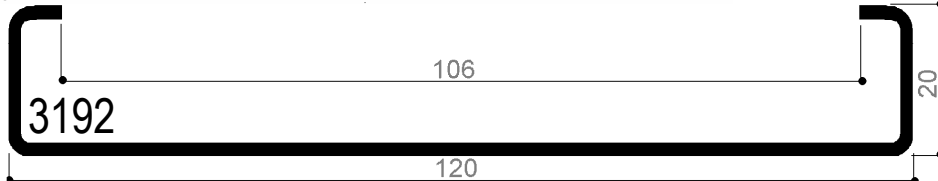

3192

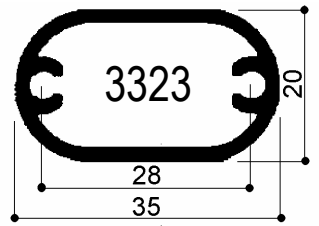

3323

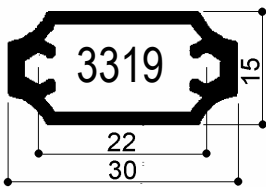

3319

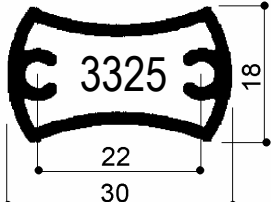

3325

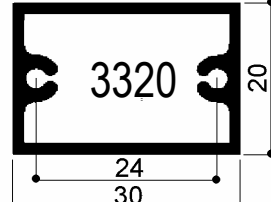

3320

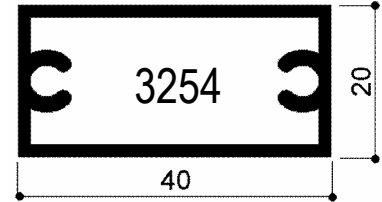

3254

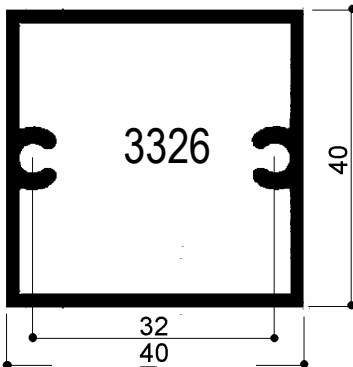

3326

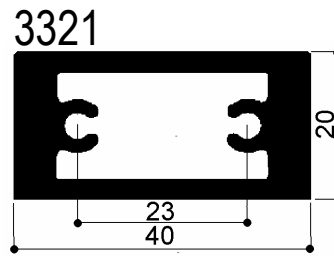

3321

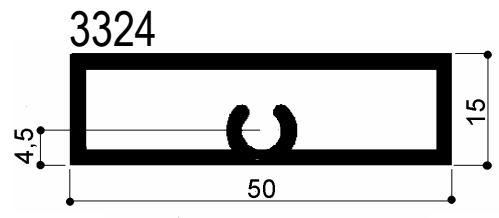

3324

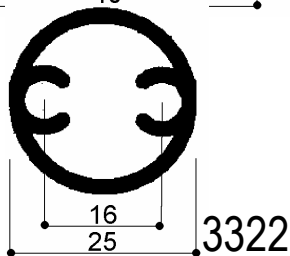

3322

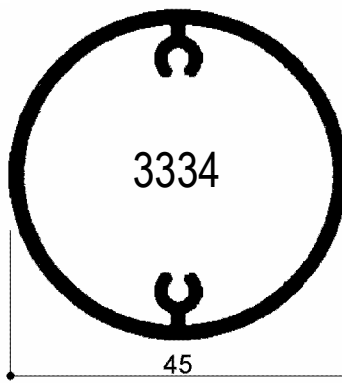

3334

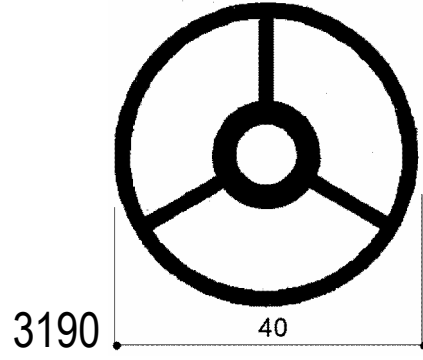

3190

-RIPRODUZIONE VIETATA-



Profili Speciali - Aluminium profile custom sections



Disegni al vero (1:1)

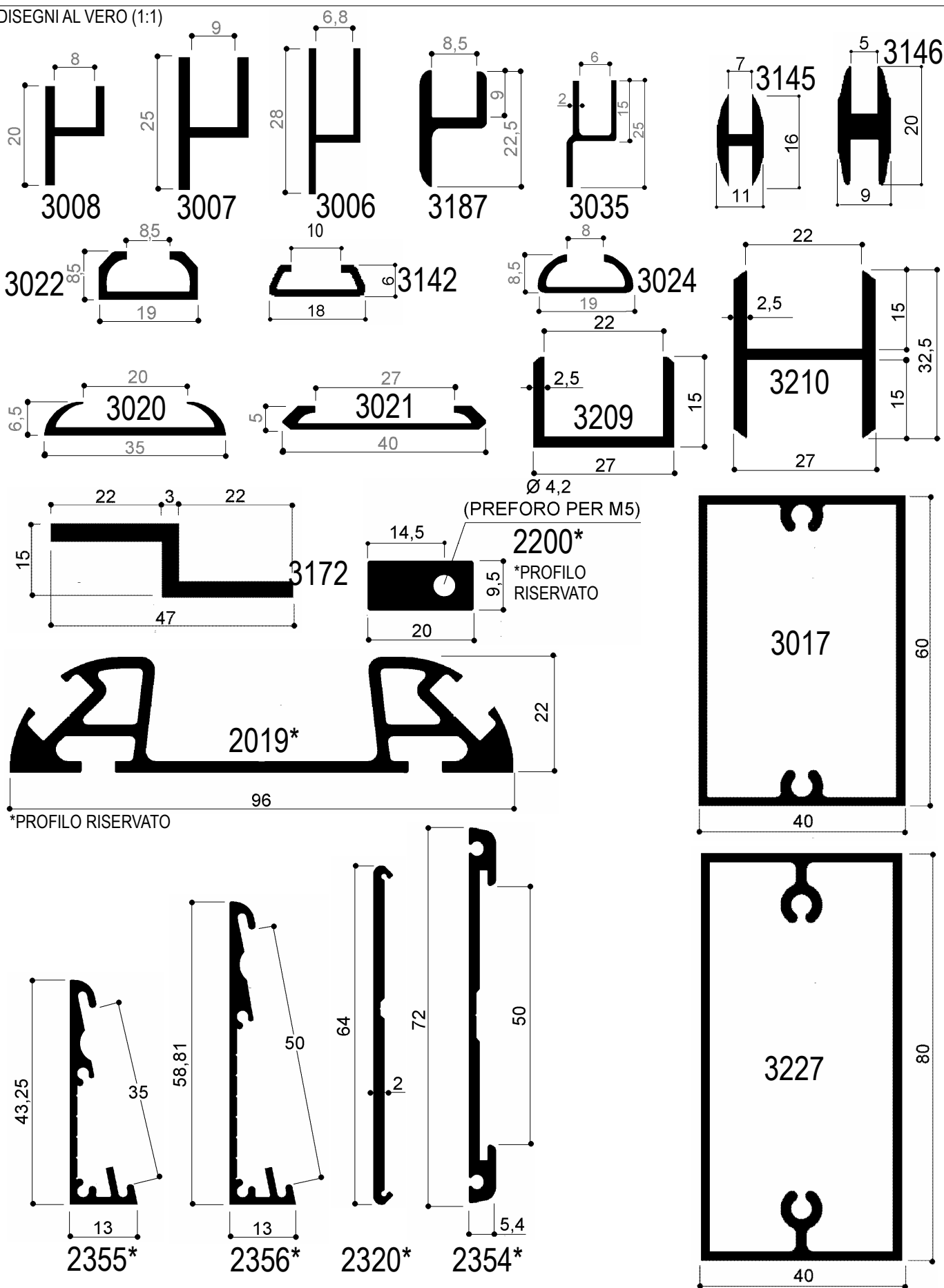

Via Newton, n.12

20016 Pero (Milano - Italy)

Tel. +39 02 3535955 r.a. Fax. +39 02 3539929

E-Mail: info@omar-alluminio.it

Cataloghi Online: www.omar-alluminio.it

www.omar-alluminio.com

PROFILATI ALLUMINIO A DISEGNO / STANDARD / SPECIALI / E PER:

ELETTRONICA / LED / FOTOVOLTAICO / AUTOMAZIONE ROBOTICA / PNEUMATICA / AUTOMOTIVE



Profili Speciali - RACLE -

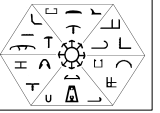

DISEGNI AL VERO (1:1)

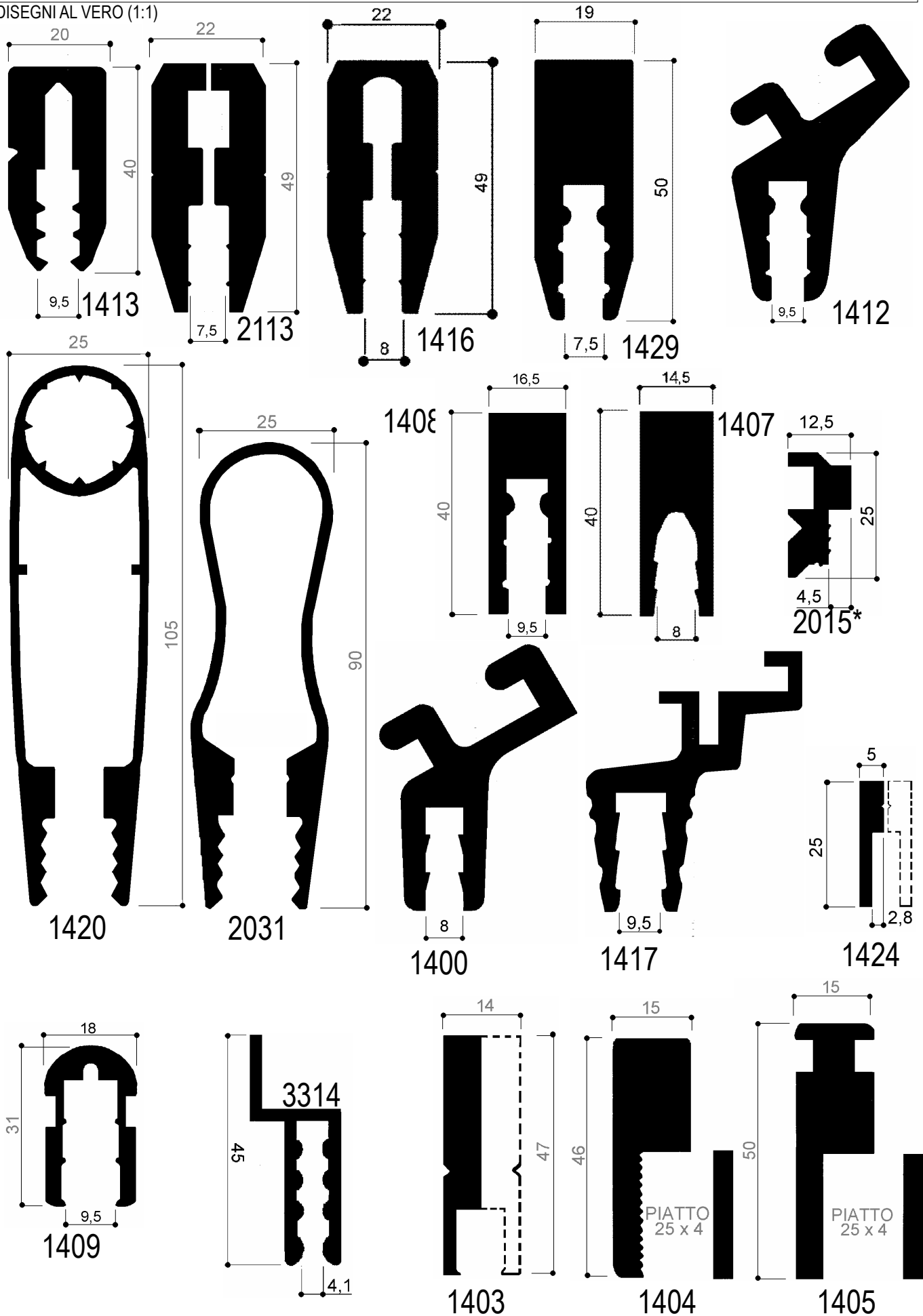

Cataloghi Online: www.omar-alluminio.it
www.omar-alluminio.com

PROFILATI ALLUMINIO A DISEGNO / STANDARD / SPECIALI / E PER:
 ELETTRONICA / LED / FOTOVOLTAICO / AUTOMAZIONE ROBOTICA / PNEUMATICA / AUTOMOTIVE

Via Newton, n.12
 20016 Pero (Milano - Italy)
 Tel. +39 02 3535955 r.a. Fax. +39 02 3539929
 E-Mail: info@omar-alluminio.it



Profili Speciali - RACLE -

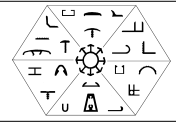

DISEGNI AL VERO (1:1)

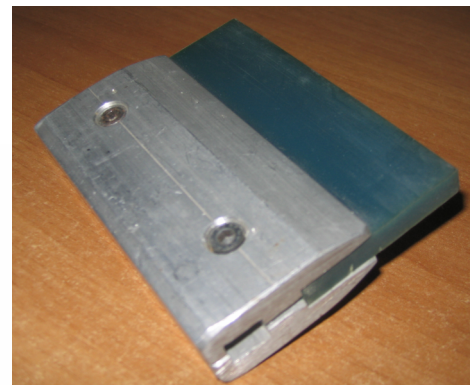
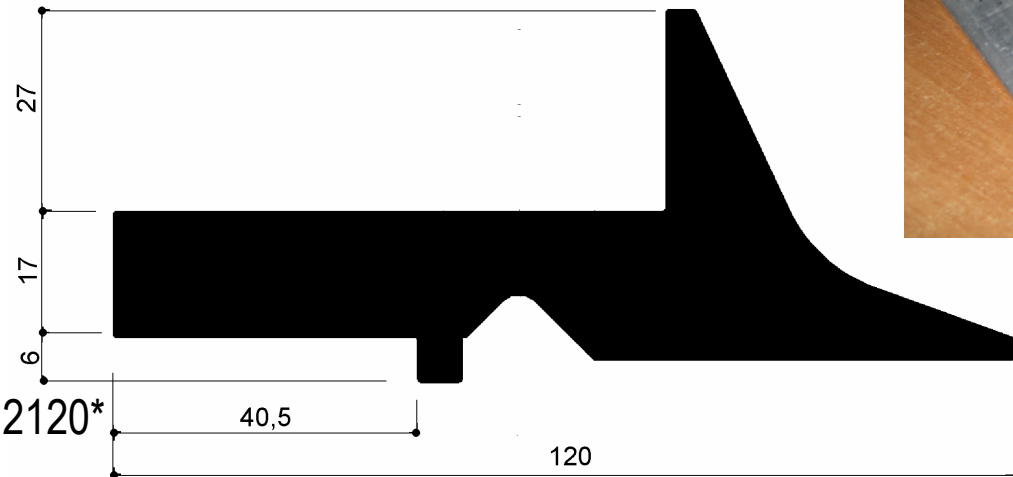
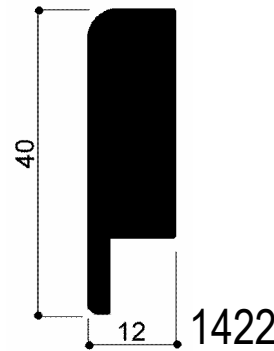
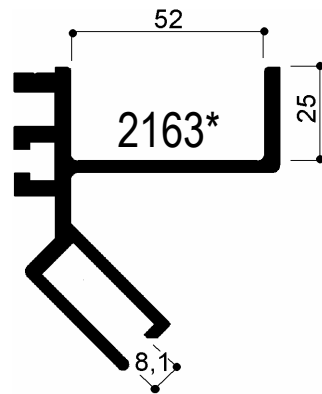
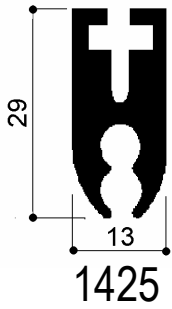
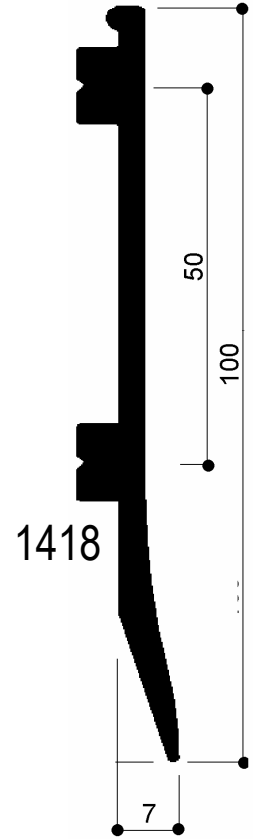
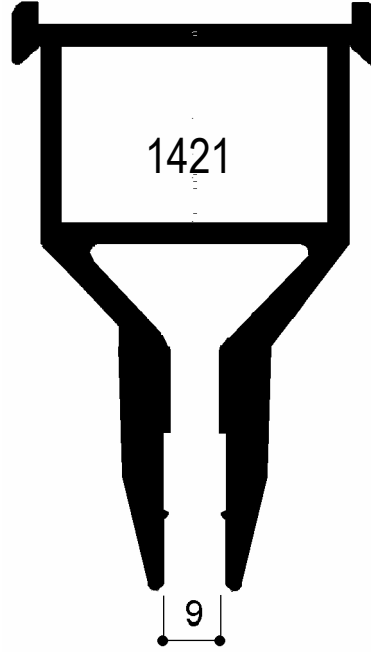
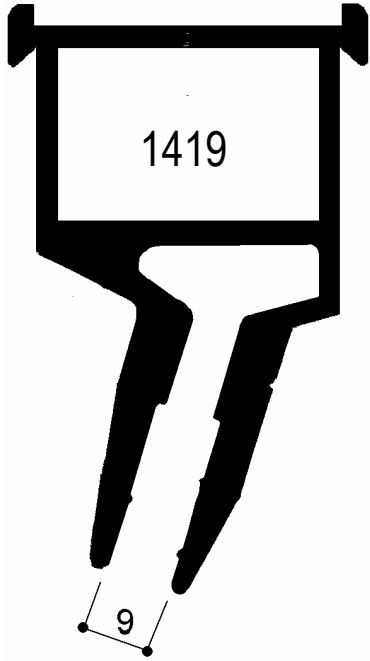

Cataloghi Online: www.omar-alluminio.it
www.omar-alluminio.com

Via Newton, n.12

20016 Pero (Milano - Italy)

Tel. +39 02 3535955 r.a. Fax. +39 02 3539929

E-Mail: info@omar-alluminio.it

PROFILATI ALLUMINIO A DISEGNO / STANDARD / SPECIALI / E PER:
 ELETTRONICA / LED / FOTOVOLTAICO / AUTOMAZIONE ROBOTICA / PNEUMATICA / AUTOMOTIVE



Profili Speciali - RACLE -

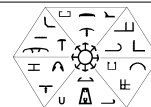

Via Newton, n. 12
20016 Pero (Milano - Italy)
Tel. +39 02 3535955 r.a. Fax. +39 02 3539929
E. Mail: info@omar-alluminio.it

Cataloghi Online: www.omar-alluminio.it
www.omar-alluminio.com

PROFILATI ALLUMINIO A DISEGNO / STANDARD / SPECIALI / E PER:
ELETTRONICA / LED / FOTOVOLTAICO / AUTOMAZIONE ROBOTICA / PNEUMATICA / AUTOMOTIVE



FOTO DI ESEMPIO: PROFILI ESTRUSI IN ALLUMINIO PORTA RACLE DA STAMPA A QUADRO SERIGRAFICA PER:
-MANOMACCHINE: REGGIANI, MECCANOTESSILE, BUSER etc...
-A CARRELLO: GALY, VIERO, ROBUSTELLI etc...
-PER IL SETTORE SERIGRAFICO: SIASPRINT, ARGON, THIEME etc..
-A GIOSTRA SERIGRAFICA: TEK-IND

RACLA

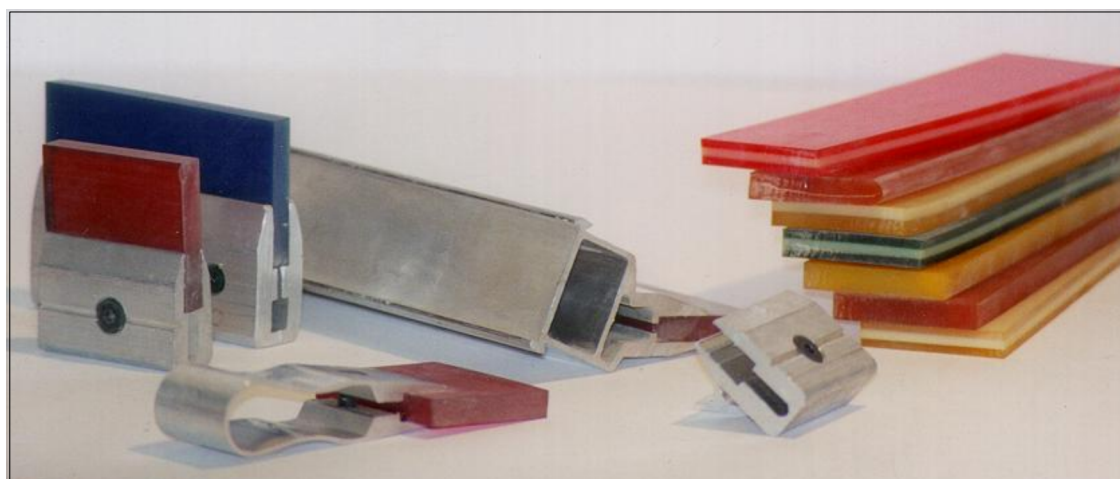
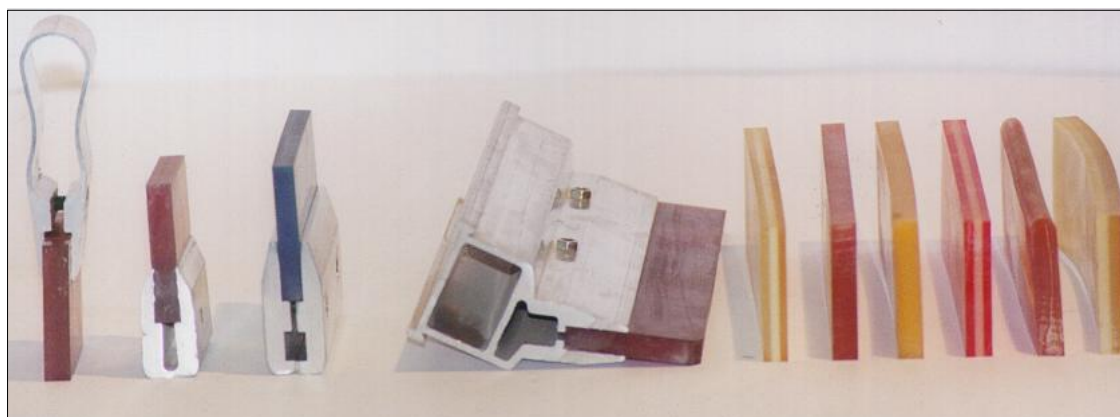

2113 LUNGHEZZA BARRE MT 4 CON
VITI A TESTA CILINDRICA M5 QUOTA PURAMENTE
INDICATIVA DEL PASSO VITI: 80MM CIRCA
(TOLLERANZA +/-5MM)

RACLA MECCANICA

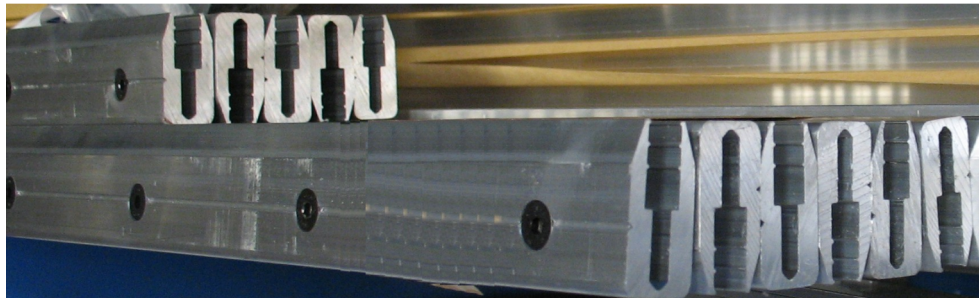

1413 / 1419 / 1421 / 1429 LUNGHEZZA BARRE MT 4 CON
VITI A TESTA SVASATA M6 QUOTA PURAMENTE INDICATIVA DEL
PASSO VITI: 100MM CIRCA (TOLLERANZA +/-5MM)

RACLA A MANO



2031 LUNGHEZZA BARRE
MT 4 CON VITI A TESTA
SVASATA M6 QUOTA PURAMENTE
INDICATIVA DEL PASSO
VITI: 100 MM CIRCA
(TOLLERANZA +/-5MM)



Profili Speciali - STADIE/STAGGE

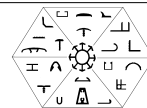

DISEGNI META' DEL VERO (1:2)- SCALE 1:2

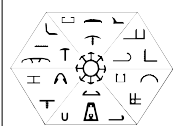
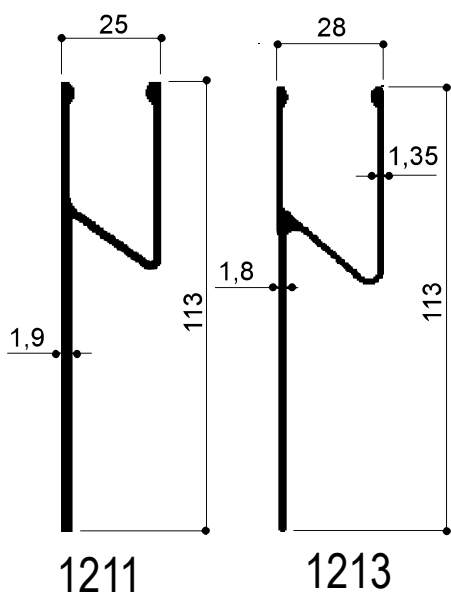
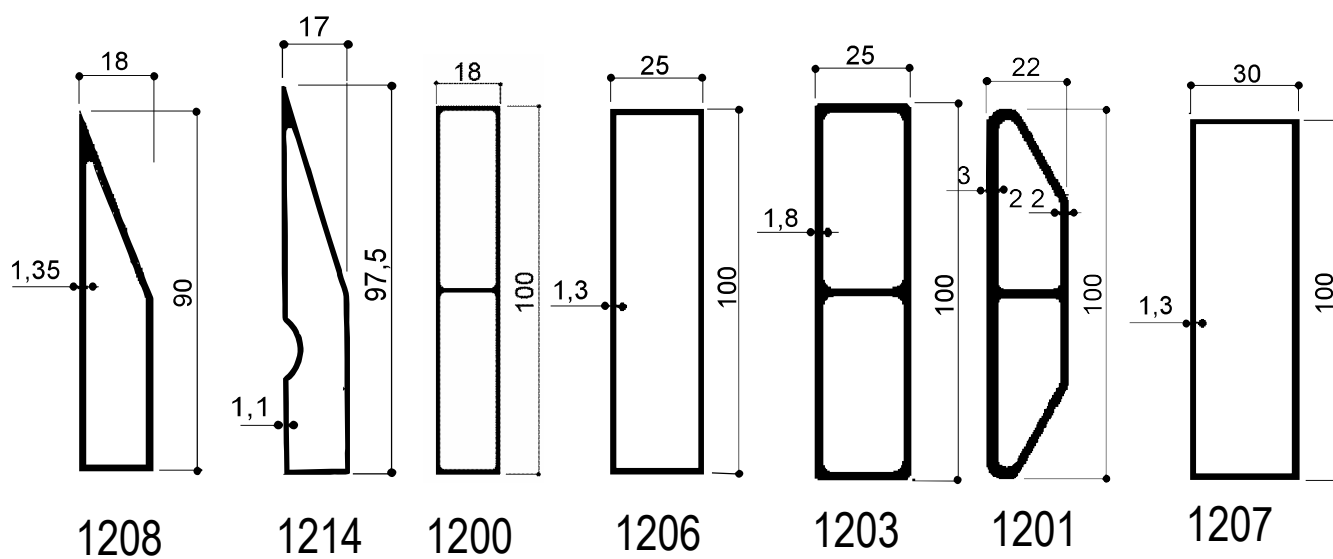
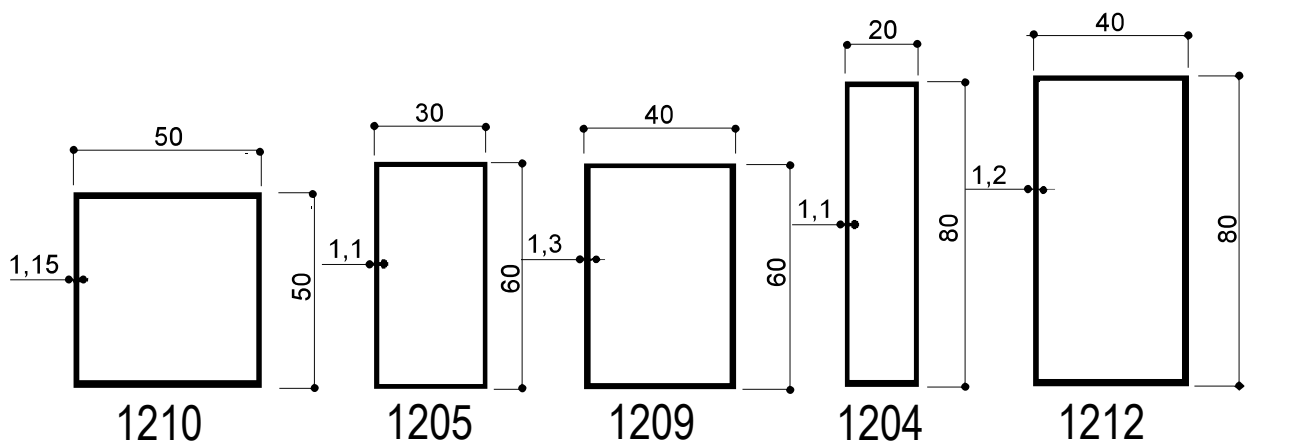

ANCHE PER MODESTE QUANTITA' SI POSSONO FORNIRE PREVIO ALLESTIMENTO MATRICE, ULTERIORI PROFILI SECONDO LE VS. SPECIFICHE

Via Newton, n.12
20016 Pero (Milano - Italy)
Tel. +39 02 3535955 r.a. Fax. +39 02 3539929
E-Mail: info@omar-alluminio.it

Cataloghi Online: www.omar-alluminio.it
www.omar-alluminio.com

PROFILATI ALLUMINIO A DISEGNO / STANDARD / SPECIALI / E PER:
ELETTRONICA / LED / FOTOVOLTAICO / AUTOMAZIONE ROBOTICA / PNEUMATICA / AUTOMOTIVE



Profili Speciali - Cantieri Nautici -

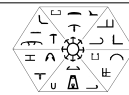

DISEGNI AL VERO (1:1)- SCALE 1:1
PLASTICA IN ROTOLI DA MT.30

Via Newton, n.12
20016 Pero (Milano - Italy)
Tel. +39 02 3535955 r.a. Fax. +39 02 3539929
E-Mail: info@omar-alluminio.it

Cataloghi Online: www.omar-alluminio.it
www.omar-alluminio.com

PROFILATI ALLUMINIO A DISEGNO / STANDARD / SPECIALI / E PER:
ELETTRONICA / LED / FOTOVOLTAICO / AUTOMAZIONE ROBOTICA / PNEUMATICA / AUTOMOTIVE

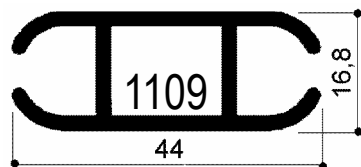
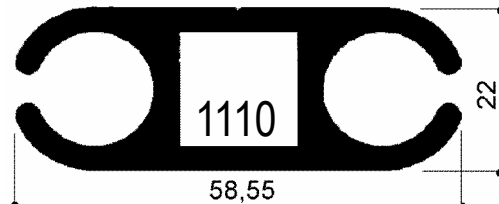
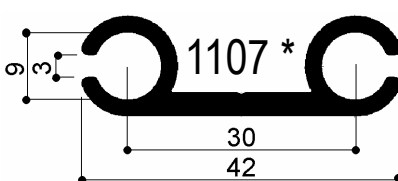
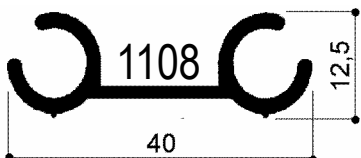
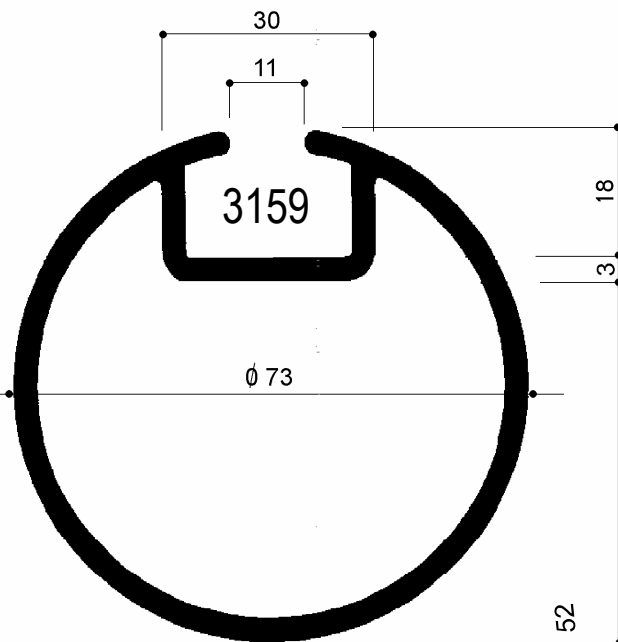
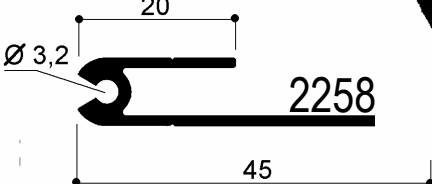
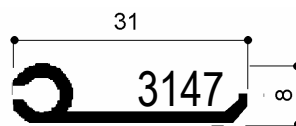
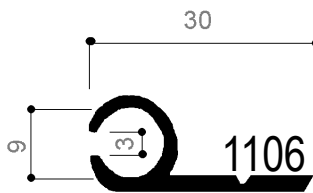
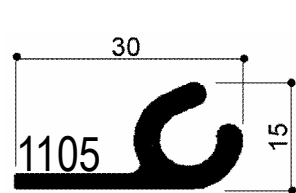
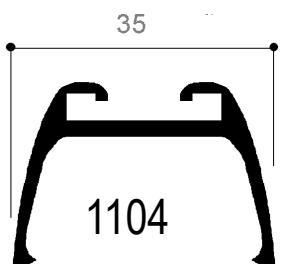
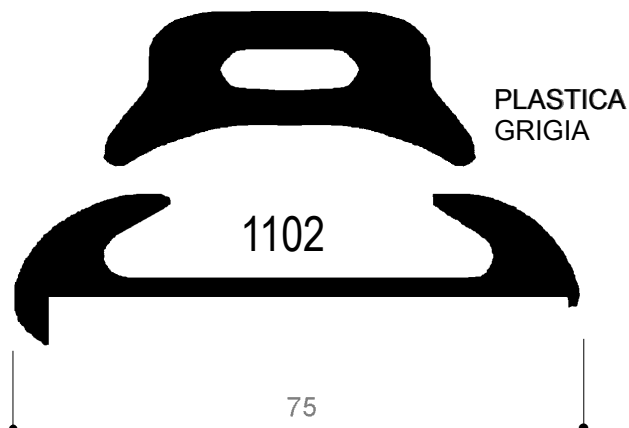
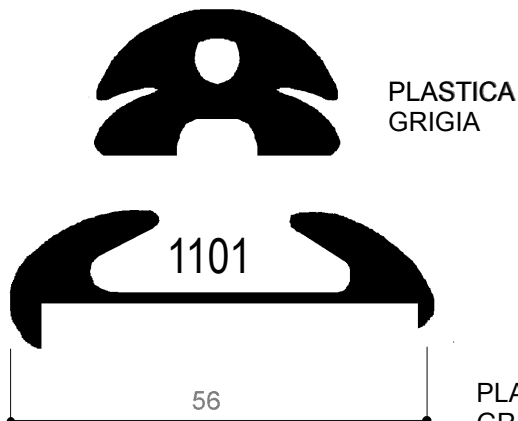
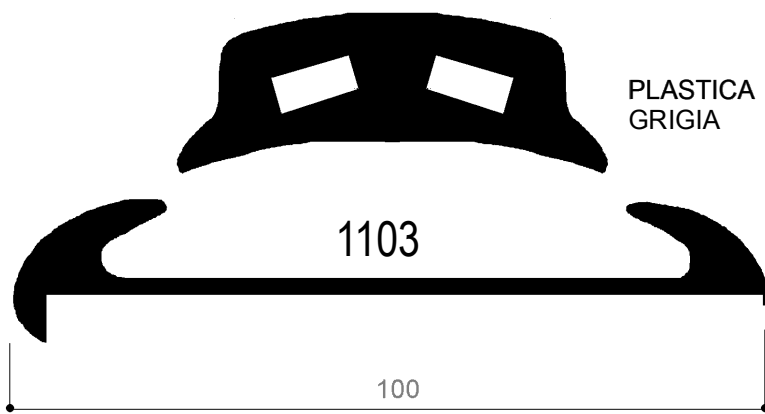
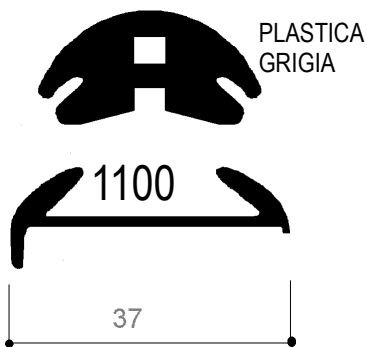

Profili Speciali - BATTISCOPIA -

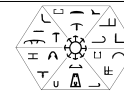

DISEGNI META' DEL VERO (1:2)- SCALE 1:2

3090 OX. SATINATO
CHIMICO NATURALE

ESEMPIO
DI MONTAGGIO

3092
OX SATINATO
CHIMICO NATURALE

3093

ESEMPIO
DI MONTAGGIO

2012*

ESEMPIO
DI MONTAGGIO

*PROFILO RISERVATO

3087 OX
SATINATO CHIMICO NATURALE

3088

ESEMPIO
DI MONTAGGIO

3085 OX SATINATO CHIMICO NATURALE

3086

ESEMPIO
DI MONTAGGIO

3271

3272 OX SATINATO
CHIMICO NATURALE

ESEMPIO
DI MONTAGGIO

3083
OX SATINATO
CHIMICO NATURALE

3084 OX SATINATO
CHIMICO NATURALE

ESEMPIO
DI MONTAGGIO

3089

3234

3235

3236

3308

3309

ESEMPIO
DI MONTAGGIO

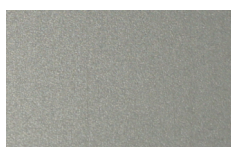

FINITURA STANDARD PRONTA A
STOCK PER TUTTI I PROFILI
ILLUSTRATI: OX SATINATO CHIMICO
NATURALE

Via Newton, n.12
20016 Pero (Milano - Italy)
Tel. +39 02 3535955 r.a. Fax. +39 02 3539929
E-Mail: info@omar-alluminio.it

Cataloghi Online: www.omar-alluminio.it
www.omar-alluminio.com
PROFILATI ALLUMINIO A DISEGNO / STANDARD / SPECIALI / E PER:
ELETTRONICA / LED / FOTOVOLTAICO / AUTOMAZIONE ROBOTICA / PNEUMATICA / AUTOMOTIVE



Profili Speciali - BATTISCOPIA -



Via Newton, n.12
20016 Pero (Milano - Italy)
Tel. +39 02 3535955 r.a. Fax. +39 02 3539929
E-Mail: info@omar-alluminio.it

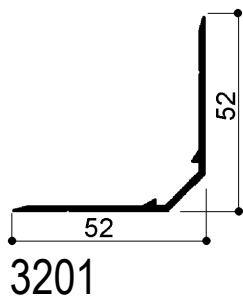

3201

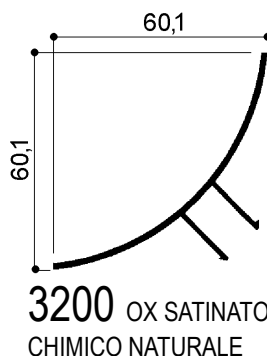

3200 OX SATINATO
CHIMICO NATURALE

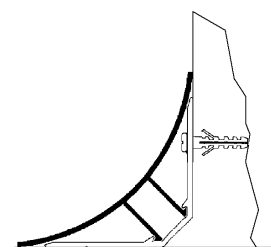

ESEMPIO
DI MONTAGGIO

ACCESSORI

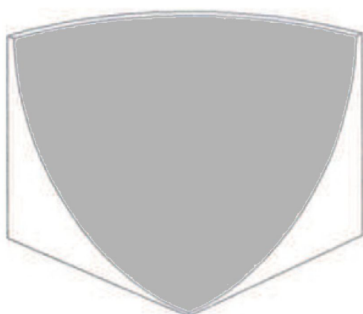

B-0001

FUSIONE IN ALLUMINIO 1/8 DI SFERA
VERNICIATO NATURALE PER
GIUNZIONE ANGOLARE DEI PROFILI 3200 / 3201

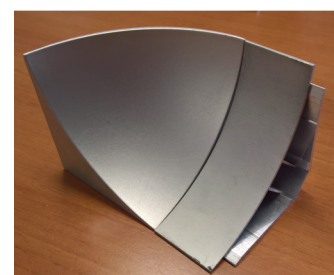

ESEMPIO DI MONTAGGIO

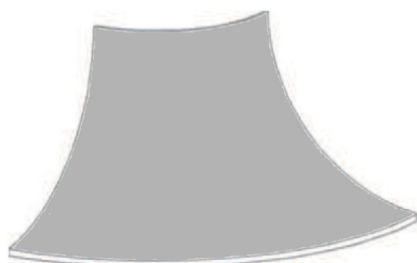

B-0002

FUSIONE IN ALLUMINIO 1/4 DI SFERA
VERNICIATO NATURALE PER GIUNZIONE
ANGOLARE DEI PROFILI 3200 / 3201

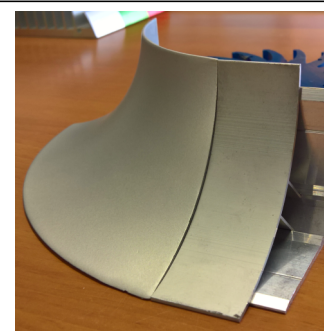

ESEMPIO DI MONTAGGIO

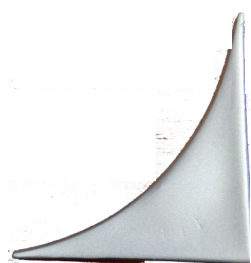

B-0003

FUSIONE IN ALLUMINIO TAPPO TERMINALE
VERNICIATO NATURALE PER I PROFILI 3200 / 3201

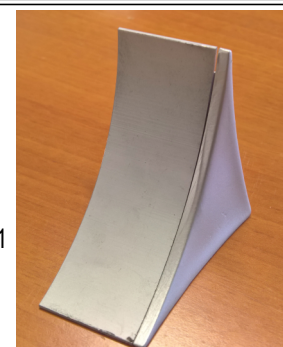

ESEMPIO DI MONTAGGIO

Cataloghi Online: www.omar-alluminio.it
www.omar-alluminio.com

PROFILATI ALLUMINIO A DISEGNO / STANDARD / SPECIALI / E PER:
ELETTRONICA / LED / FOTOVOLTAICO / AUTOMAZIONE ROBOTICA / PNEUMATICA / AUTOMOTIVE

OMAR s.p.a.
PROFILATI ALLUMINIO
ALTA TECNOLOGIA

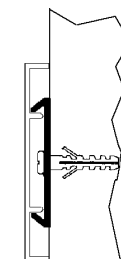
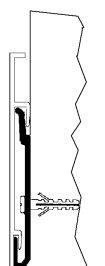
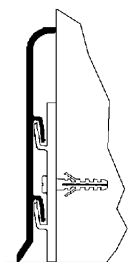
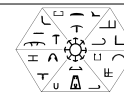

Via Newton, n.12
20016 Pero (Milano - Italy)
Tel. +39 02 3535955 r.a. Fax. +39 02 3539929
E-Mail: info@omar-alluminio.it

ELENCO FINITURE DISPONIBILI SU RICHIESTA

FINITURA: ANODIZZATO

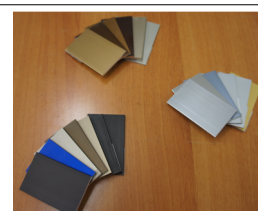

ELETTROCOLORE BRONZO 15	ELETTROCOLORE BRONZO 16	ELETTROCOLORE BRONZO 17	ELETTROCOLORE BRONZO 18	ELETTROCOLORE BRONZO 19	ELETTROCOLORE BRONZO 20
ELETTROCOLORE COD.1	ELETTROCOLORE COD.2	ELETTROCOLORE COD.3	ELETTROCOLORE COD.4	ELETTROCOLORE COD.5	ELETTROCOLORE COD.6
BLU COBALTO	ORO	ARGENTO SPAZZOLATO	ARGENTO CHIMICO FINITURA STANDARD DISPONIBILE 'DAL PRONTO'	FUME'	ACCIAIO
TITANIO LUCIDO					

FINITURA: VERNICIATO

COD.K06	COD.K09	COD.K17	COD.K20	COD.K23	COD.K31
COD.K35	COD.K38	COD.K40			

Cataloghi Online: www.omar-alluminio.it
www.omar-alluminio.com

PROFILATI ALLUMINIO A DISEGNO / STANDARD / SPECIALI / E PER:
ELETTRONICA / LED / FOTOVOLTAICO / AUTOMAZIONE ROBOTICA / PNEUMATICA / AUTOMOTIVE



Profili Speciali - ARREDO URBANO

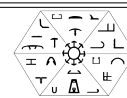

Via Newton, n.12
20016 Pero (Milano - Italy)
Tel. +39 02 3535955 r.a. Fax. +39 02 3539929
E-Mail: info@omar-alluminio.it

Cataloghi Online: www.omar-alluminio.it
www.omar-alluminio.com

PROFILATI ALLUMINIO A DISEGNO / STANDARD / SPECIALI / E PER:
ELETTRONICA / LED / FOTOVOLTAICO / AUTOMAZIONE ROBOTICA / PNEUMATICA / AUTOMOTIVE

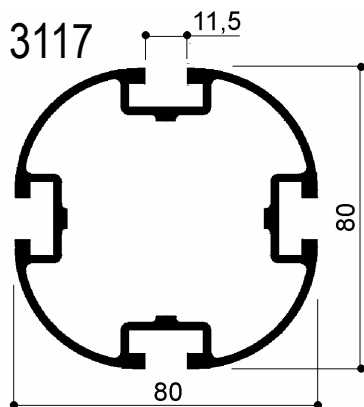

DISEGNI META' DEL VERO (1:2)- SCALE 1:2

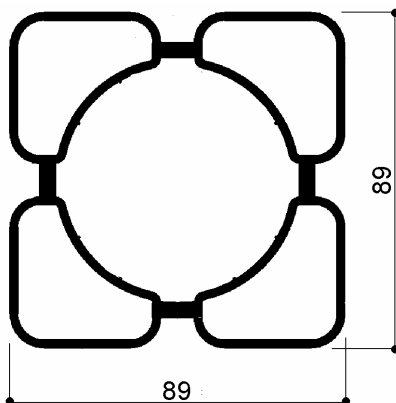
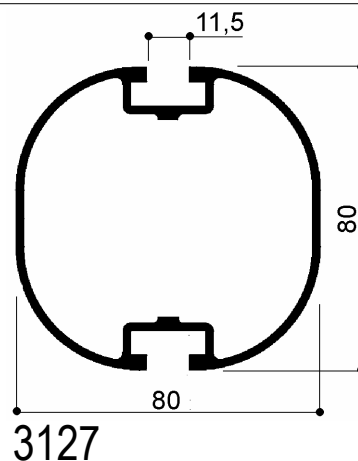
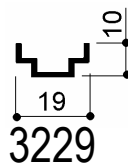

PROFILO RISERVATO

-RIPRODUZIONE VIETATA-

Profili Speciali - Soglie -

DISEGNI AL VERO (1:1)- SCALE 1:1

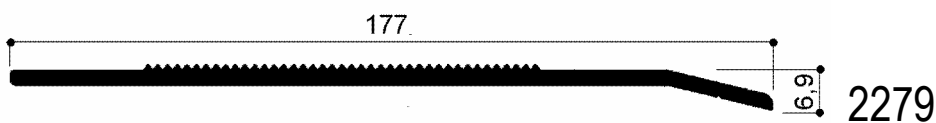

DISEGNI META' DEL VERO (1:2)- SCALE 1:2

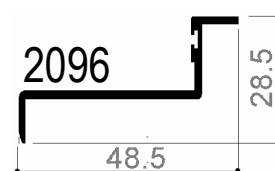
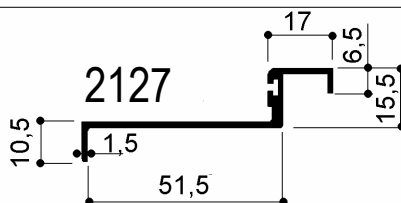
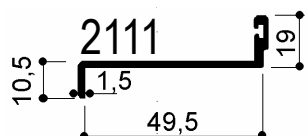

DISEGNI AL VERO (1:1)- SCALE 1:1

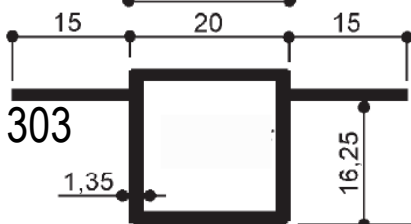
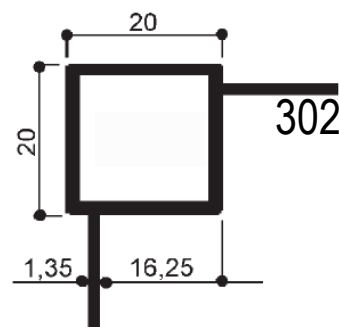
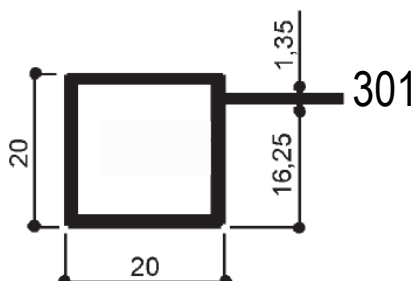
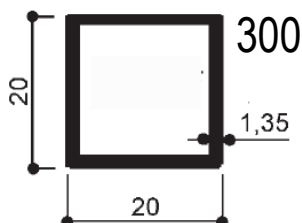



FOTO DI ESEMPIO: PROFILI IN ALLUMINIO ESTRUSO PIATTI DI GRANDI DIMENSIONI
LEGA 6060 - 6082



FOTO DI ESEMPIO: PROFILI IN ALLUMINIO ESTRUSO
CANNE PER LA REALIZZAZIONE DI CILINDRI PNEUMATICI

Consultate il catalogo aggiornato online su:

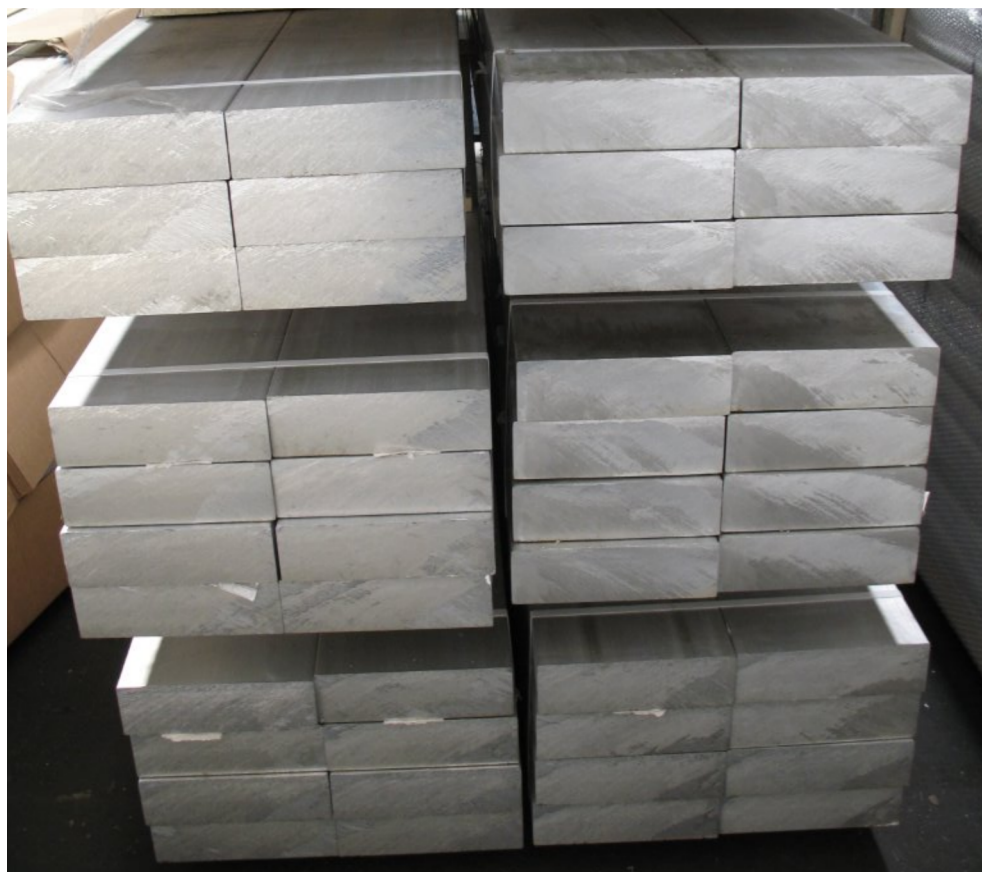
www.omar-alluminio.it

www.omar-alluminio.com

www.angolari-alluminio.it

www.canalini-alluminio.it

www.coprigiunti-alluminio.biz

www.fermavetro.biz

www.fermapassatoie.com

www.microprofili-alluminio.it

www.piatti-alluminio.it

www.piatti-trafilati-alluminio.biz

www.profilati-h-alluminio.it

www.profilati-omega-alluminio.it

www.profilati-t-alluminio.it

www.profilati-z-alluminio.it

www.semitondi-alluminio.biz

www.travi-alluminio.eu

www.tubi-alluminio.it

www.unghietta-alluminio.biz

Via Newton, n.12

20016 Pero (Milano - Italy)

Tel. +39 02 3535955 r.a. Fax. +39 02 3539929

E-Mail: info@omar-alluminio.it

Cataloghi Online: www.omar-alluminio.it

www.omar-alluminio.com

PROFILATI ALLUMINIO A DISEGNO / STANDARD / SPECIALI / E PER:

ELETTRONICA / LED / FOTOVOLTAICO / AUTOMAZIONE ROBOTICA / PNEUMATICA / AUTOMOTIVE

ACCESSORI per contenitori porta schede elettroniche tipo DIN 43700

-DISEGNI PROFILI vedi pag. 1 -



Via Newton, n.12
20016 Pero (Milano - Italy)
Tel. +39 02 3535955 r.a. Fax. +39 02 3539929
E.Mail: info@omar-alluminio.it

Cataloghi Online: www.omar-alluminio.it
www.omar-alluminio.com

PROFILATI ALLUMINIO A DISEGNO / STANDARD / SPECIALI / E PER:
ELETTRONICA / LED / FOTOVOLTAICO / AUTOMAZIONE ROBOTICA / PNEUMATICA / AUTOMOTIVE

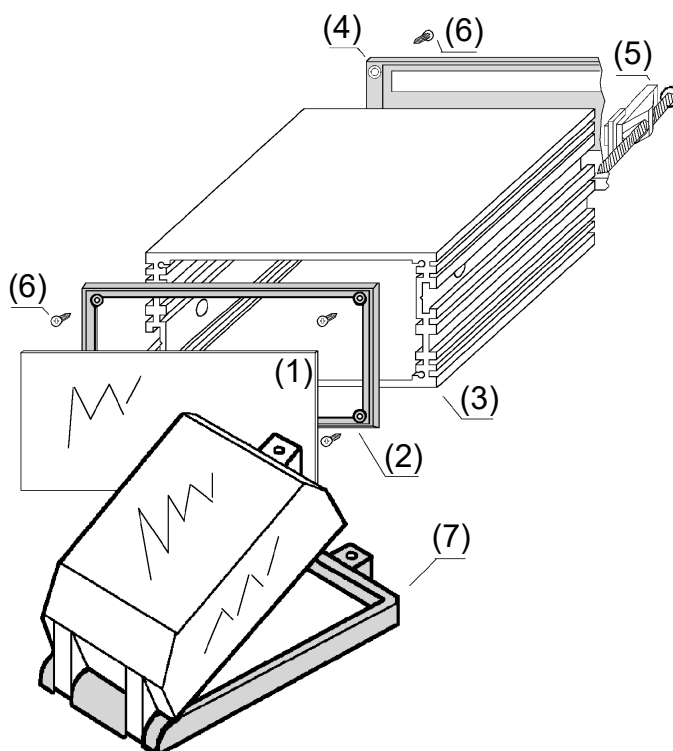

(1) PANNELLO ANTERIORE IN ALLUMINIO TUTTO CHIUSO SPESSORE 15/10 OSSIDATO ARGENTO CON 'PELABILE'. PRONTO PER EVENTUALI PERSONALIZZAZIONI CON FORATURE "CUSTOM" ED EVENTUALE SERIGRAFIA

(2) CORNICE ANTERIORE COLORE NERO IN NYLON6 - FIBRA VETRO 30%

(3) CORPO CONTENITORE IN ALLUMINIO CON PROFONDITA' LIBERA. DISPONIBILE CON DIFFERENTI TRATTAMENTI SUPERFICIALI (OSSIDAZIONE: NERA, NATURALE, ROSSO, BLU, VERDE ETC.). SONO POSSIBILI LAVORAZIONI MECCANICHE (FORI, TAGLI, FRESATURE)

(4) FONDELLO POSTERIORE COLORE NERO IN NYLON 6 - FIBRA VETRO 30%
FORNIBILE IN DIVERSE SOLUZIONI (FONDELLO APERTO, CHIUSO, 1/2 APERTO, CON FESSURE A STRAPPO)

(5) AGGANCI DI FISSAGGIO IN MATERIALE PLASTICO NERO PER MONTAGGIO A PANNELLO

(6) VITI AUTOFILETTANTI BRUNITE PER FISSAGGIO CORNICI O PANNELLI IN ALLUMINIO

(7) PROTEZIONE ANTISPRUZZO IN POLICARBONATO TRASPARENTE

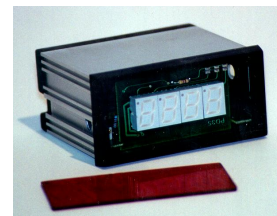
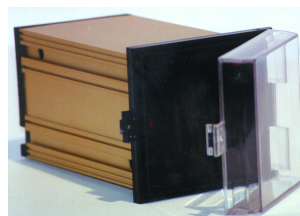
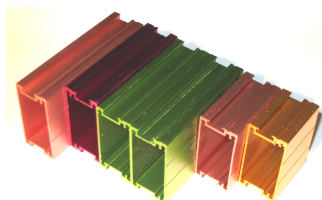

Consultate il Catalogo aggiornato Online
all'indirizzo www.omar-alluminio.it

Indice Articoli

COD.	TIPO ARTICOLO	PAG	COD.	TIPO ARTICOLO	PAG	COD.	TIPO ARTICOLO	PAG
100	DISSIPATORE	62	335	PROFILI FOTOVOLTAICO	70	461	DISSIPATORE	46
101	DISSIPATORE	62	345	PROFILI COM PONIBILI	69	462	DISSIPATORE	31
103	DISSIPATORE	62	357	PROFILI COM PONIBILI	66	463	DISSIPATORE	30
104	DISSIPATORE	62	358	PROFILI COM PONIBILI	66	464	DISSIPATORE	31
105	DISSIPATORE	62	359	PROFILI FOTOVOLTAICO	70	465	DISSIPATORE	34
106	DISSIPATORE	62	360	PROFILI COM PONIBILI	69	466	DISSIPATORE	41
108	DISSIPATORE	62	361	PROFILI COM PONIBILI	69	467	DISSIPATORE	44
109	DISSIPATORE	62	362	PROFILI COM PONIBILI	69	468	DISSIPATORE	49
110	DISSIPATORE	62	363	PROFILI COM PONIBILI	69	469	DISSIPATORE	50
111	DISSIPATORE	62	364	PROFILI COM PONIBILI	69	470	DISSIPATORE	44
112	DISSIPATORE	62	365	PROFILI COM PONIBILI	69	471	DISSIPATORE	42
113	DISSIPATORE	62	366	PROFILI COM PONIBILI	69	472	DISSIPATORE	45
117	DISSIPATORE	62	367	PROFILI COM PONIBILI	69	473	DISSIPATORE	46
121	DISSIPATORE	62	371	PROFILI COM PONIBILI	74	474	DISSIPATORE	45
122	DISSIPATORE	62	372	PROFILI COM PONIBILI	75	475	DISSIPATORE	33
123	DISSIPATORE	62	373	PROFILI COM PONIBILI	76	476	DISSIPATORE	32
124	DISSIPATORE	62	374	PROFILI COM PONIBILI	77	477	DISSIPATORE	29
130	DISSIPATORE	62	375	PROFILI COM PONIBILI	78	478	DISSIPATORE	47
134	DISSIPATORE	62	376	PROFILI COM PONIBILI	74	479	DISSIPATORE	40
135	DISSIPATORE	62	377	PROFILI COM PONIBILI	75	480	DISSIPATORE	35
144	DISSIPATORE	62	400	DISSIPATORE	4	481	DISSIPATORE	38
146	DISSIPATORE	62	401	DISSIPATORE	4	482	DISSIPATORE	39
147	DISSIPATORE	62	402	DISSIPATORE	4	483	DISSIPATORE	37
149	DISSIPATORE	62	403	DISSIPATORE	4	484	DISSIPATORE	36
160	DISSIPATORE	61	404	DISSIPATORE	4	485	DISSIPATORE	42
161	DISSIPATORE	61	405	DISSIPATORE	4	486	DISSIPATORE	32
162	DISSIPATORE	61	406	DISSIPATORE	4	487	DISSIPATORE	36
163	DISSIPATORE	61	408	DISSIPATORE	5	489	DISSIPATORE	37
164	DISSIPATORE	61	409	DISSIPATORE	5	490	DISSIPATORE	48
165	DISSIPATORE	61	410	DISSIPATORE	5	491	DISSIPATORE	41
166	DISSIPATORE	61	411	DISSIPATORE	5	492	DISSIPATORE	38
167	DISSIPATORE	61	412	DISSIPATORE	5	493	DISSIPATORE	39
168	DISSIPATORE	61	413	DISSIPATORE	4	494	DISSIPATORE	43
169	DISSIPATORE	61	414	DISSIPATORE	53	495	DISSIPATORE	47
170	DISSIPATORE	61	415	DISSIPATORE	5	496	DISSIPATORE	48
171	DISSIPATORE	61	416	DISSIPATORE	5	497	DISSIPATORE	49
180	DISSIPATORE	61	419	DISSIPATORE	4	500	DISSIPATORE	6
188	DISSIPATORE	61	420	DISSIPATORE	53	503	DISSIPATORE	7
189	DISSIPATORE	61	421	DISSIPATORE	5	505	DISSIPATORE	8
190	DISSIPATORE	61	423	DISSIPATORE	4	513	DISSIPATORE	10
195	DISSIPATORE	61	424	DISSIPATORE	53	525	DISSIPATORE	13
238	DISSIPATORE	63	427	DISSIPATORE	50	526	DISSIPATORE	6
239	DISSIPATORE	63	428	DISSIPATORE	57	527	DISSIPATORE	57
240	DISSIPATORE	63	429	DISSIPATORE	11	528	DISSIPATORE	57
241	DISSIPATORE	63	430	DISSIPATORE	12	529	DISSIPATORE	9
243	DISSIPATORE	63	432	DISSIPATORE	11	530	DISSIPATORE	12
244	DISSIPATORE	63	433	DISSIPATORE	14	531	DISSIPATORE	7
246	DISSIPATORE	63	434	DISSIPATORE	21	532	DISSIPATORE	10
247	DISSIPATORE	63	438	DISSIPATORE	9	533	DISSIPATORE	57
248	DISSIPATORE	63	439	DISSIPATORE	10	534	DISSIPATORE	57
249	DISSIPATORE	63	440	DISSIPATORE	11	537	DISSIPATORE	7
250	DISSIPATORE	63	441	DISSIPATORE	7	545	DISSIPATORE	7
251	DISSIPATORE	61	442	DISSIPATORE	5	600	DISSIPATORE	52
252	DISSIPATORE	61	443	DISSIPATORE	10	601	DISSIPATORE	52
254	DISSIPATORE	61	444	DISSIPATORE	9	602	DISSIPATORE	52
271	DISSIPATORE	63	445	DISSIPATORE	19	603	DISSIPATORE	51
272	DISSIPATORE	63	446	DISSIPATORE	5	604	DISSIPATORE	52
300	PROFILI SPECIALI	118	447	DISSIPATORE	4	605	DISSIPATORE	52
301	PROFILI SPECIALI	118	449	DISSIPATORE	5	608	DISSIPATORE	51
302	PROFILI SPECIALI	118	450	DISSIPATORE	28	610	DISSIPATORE	51
303	PROFILI SPECIALI	118	451	DISSIPATORE	29	611	DISSIPATORE	51
304	PROFILI COM PONIBILI	66	452	DISSIPATORE	30	613	DISSIPATORE	51
305	PROFILI COM PONIBILI	70	453	DISSIPATORE	28	617	DISSIPATORE	7
306	PROFILI COM PONIBILI	65	454	DISSIPATORE	30	618	DISSIPATORE	7
307	PROFILI COM PONIBILI	65	455	DISSIPATORE	33	619	DISSIPATORE	51
310	PROFILI SPECIALI	74	456	DISSIPATORE	40	620	DISSIPATORE	50
311	PROFILI SPECIALI	74	457	DISSIPATORE	43	621	DISSIPATORE	51
328	PROFILI COM PONIBILI	65	458	DISSIPATORE	28	622	DISSIPATORE	20
330	PROFILI COM PONIBILI	67	459	DISSIPATORE	29	624	DISSIPATORE	15
333	PROFILI FOTOVOLTAICO	70	460	DISSIPATORE	34	626	DISSIPATORE	51

Consultate il Catalogo aggiornato Online
 all'indirizzo www.omar-alluminio.it

Indice Articoli

629	DISSIPATORE	10	768	PROFILI COM PONIBILI	72	853	DISSIPATORE	16
633	DISSIPATORE	50	769	PROFILI COM PONIBILI	65	855	DISSIPATORE	20
634	DISSIPATORE	17	770	PROFILI COM PONIBILI	65	856	DISSIPATORE	8
637	DISSIPATORE	52	771	PROFILI COM PONIBILI	65	857	DISSIPATORE	8
638	DISSIPATORE	52	772	PROFILI FOTOVOLTAICO	72	858	DISSIPATORE	9
639	DISSIPATORE	52	773	PROFILI FOTOVOLTAICO	72	863	DISSIPATORE	8
640	DISSIPATORE	53	774	PROFILI COM PONIBILI	72	865	DISSIPATORE	22
641	DISSIPATORE	53	775	PROFILI COM PONIBILI	68	867	DISSIPATORE	9
642	DISSIPATORE	52	776	PROFILI COM PONIBILI	66	869	DISSIPATORE	9
645	DISSIPATORE	54	777	PROFILI COM PONIBILI	66	871	DISSIPATORE	24
646	DISSIPATORE	55	778	PROFILI COM PONIBILI	68	872	DISSIPATORE	18
647	DISSIPATORE	9	779	PROFILI COM PONIBILI	68	873	DISSIPATORE	20
648	DISSIPATORE	51	780	PROFILI COM PONIBILI	68	874	DISSIPATORE	21
649	DISSIPATORE	6	784	PROFILI COM PONIBILI	65	875	DISSIPATORE	20
650	DISSIPATORE	6	785	PROFILI COM PONIBILI	65	876	DISSIPATORE	23
651	DISSIPATORE	4	786	PROFILI COM PONIBILI	68	879	DISSIPATORE	17
652	DISSIPATORE	21	787	PROFILI FOTOVOLTAICO	70	880	DISSIPATORE	17
653	DISSIPATORE	10	789	PROFILI COM PONIBILI	65	881	DISSIPATORE	16
654	DISSIPATORE	53	796	PROFILI COM PONIBILI	70	882	DISSIPATORE	7
708	PROFILI COM PONIBILI	68	797	PROFILI FOTOVOLTAICO	70	883	DISSIPATORE	6
709	PROFILI COM PONIBILI	68	801	DISSIPATORE	4	884	DISSIPATORE	6
710	PROFILI COM PONIBILI	68	802	DISSIPATORE	4	885	DISSIPATORE	13
711	PROFILI COM PONIBILI	68	803	DISSIPATORE	12	886	DISSIPATORE	10
715	PROFILI COM PONIBILI	73	804	DISSIPATORE	15	887	DISSIPATORE	13
716	PROFILI COM PONIBILI	73	805	DISSIPATORE	12	888	DISSIPATORE	6
717	PROFILI COM PONIBILI	73	806	DISSIPATORE	4	889	DISSIPATORE	11
718	PROFILI COM PONIBILI	73	807	DISSIPATORE	4	890	DISSIPATORE	9
719	PROFILI COM PONIBILI	73	808	DISSIPATORE	5	891	DISSIPATORE	14
720	PROFILI COM PONIBILI	73	809	DISSIPATORE	6	892	DISSIPATORE	8
721	PROFILI COM PONIBILI	73	810	DISSIPATORE	6	893	DISSIPATORE	6
722	PROFILI COM PONIBILI	73	811	DISSIPATORE	5	894	DISSIPATORE	19
723	PROFILI COM PONIBILI	73	812	DISSIPATORE	6	895	DISSIPATORE	11
724	PROFILI COM PONIBILI	73	813	DISSIPATORE	8	896	DISSIPATORE	15
725	PROFILI COM PONIBILI	73	814	DISSIPATORE	12	897	DISSIPATORE	20
726	PROFILI COM PONIBILI	67	815	DISSIPATORE	7	898	DISSIPATORE	14
727	PROFILI COM PONIBILI	67	816	DISSIPATORE	8	899	DISSIPATORE	21
729	PROFILI COM PONIBILI	67	817	DISSIPATORE	8	900	DISSIPATORE	11
730	PROFILI COM PONIBILI	66	818	DISSIPATORE	9	901	DISSIPATORE	15
731	PROFILI COM PONIBILI	66	819	DISSIPATORE	9	902	DISSIPATORE	21
732	PROFILI COM PONIBILI	66	820	DISSIPATORE	9	903	DISSIPATORE	11
733	PROFILI COM PONIBILI	66	821	DISSIPATORE	24	904	DISSIPATORE	12
734	PROFILI COM PONIBILI	66	822	DISSIPATORE	15	905	DISSIPATORE	12
735	PROFILI COM PONIBILI	65	823	DISSIPATORE	10	906	DISSIPATORE	8
736	PROFILI COM PONIBILI	65	824	DISSIPATORE	15	907	DISSIPATORE	9
737	PROFILI COM PONIBILI	65	825	DISSIPATORE	10	908	DISSIPATORE	59
739	PROFILI COM PONIBILI	66	826	DISSIPATORE	14	909	DISSIPATORE	6
740	PROFILI COM PONIBILI	66	827	DISSIPATORE	11	910	DISSIPATORE	24
741	PROFILI COM PONIBILI	67	828	DISSIPATORE	11	911	DISSIPATORE	16
742	PROFILI COM PONIBILI	67	829	DISSIPATORE	12	912	DISSIPATORE	14
743	PROFILI COM PONIBILI	67	830	DISSIPATORE	12	913	DISSIPATORE	52
745	PROFILI COM PONIBILI	66	831	DISSIPATORE	8	914	DISSIPATORE	7
746	PROFILI COM PONIBILI	65	832	DISSIPATORE	8	915	DISSIPATORE	6
747	PROFILI COM PONIBILI	66	833	DISSIPATORE	6	916	DISSIPATORE	8
748	PROFILI COM PONIBILI	68	834	DISSIPATORE	6	917	DISSIPATORE	60
749	PROFILI COM PONIBILI	68	835	DISSIPATORE	16	918	DISSIPATORE	24
750	PROFILI COM PONIBILI	66	836	DISSIPATORE	22	919	DISSIPATORE	6
751	PROFILI COM PONIBILI	68	837	DISSIPATORE	6	920	DISSIPATORE	19
752	PROFILI COM PONIBILI	68	838	DISSIPATORE	13	921	DISSIPATORE	9
753	PROFILI COM PONIBILI	67	839	DISSIPATORE	6	922	DISSIPATORE	60
754	PROFILI COM PONIBILI	66	841	DISSIPATORE	4	923	DISSIPATORE	60
755	PROFILI COM PONIBILI	65	842	DISSIPATORE	9	924	DISSIPATORE	16
756	PROFILI COM PONIBILI	65	843	DISSIPATORE	8	925	DISSIPATORE	18
757	PROFILI COM PONIBILI	65	844	DISSIPATORE	12	926	DISSIPATORE	22
759	PROFILI COM PONIBILI	66	845	DISSIPATORE	9	927	DISSIPATORE	22
760	PROFILI COM PONIBILI	65	846	DISSIPATORE	14	928	DISSIPATORE	16
761	PROFILI COM PONIBILI	72	847	DISSIPATORE	9	929	DISSIPATORE	18
762	PROFILI COM PONIBILI	72	848	DISSIPATORE	12	930	DISSIPATORE	23
763	PROFILI COM PONIBILI	72	849	DISSIPATORE	10	931	DISSIPATORE	10
764	PROFILI COM PONIBILI	72	850	DISSIPATORE	13	932	DISSIPATORE	17
765	PROFILI COM PONIBILI	72	851	DISSIPATORE	10	933	DISSIPATORE	20
766	PROFILI COM PONIBILI	72	852	DISSIPATORE	15	934	DISSIPATORE	6

Consultate il Catalogo aggiornato Online
all'indirizzo www.omar-alluminio.it

Indice Articoli

936	DISSIPATORE	12	1200	PROFILI SPECIALI	111	2047	DISSIPATORE	3
937	DISSIPATORE	16	1201	PROFILI SPECIALI	111	2048	DISSIPATORE	3
938	DISSIPATORE	8	1203	PROFILI SPECIALI	111	2049	DISSIPATORE	59
939	DISSIPATORE	8	1204	PROFILI SPECIALI	111	2052	CONTENITORE ELETTRONICA	3
940	DISSIPATORE	14	1205	PROFILI SPECIALI	111	2058	PROFILI SPECIALI	118
944	DISSIPATORE	8	1206	PROFILI SPECIALI	111	2065	CONTENITORE ELETTRONICA	2
945	DISSIPATORE	7	1207	PROFILI SPECIALI	111	2072	DISSIPATORE	7
946	DISSIPATORE	22	1208	PROFILI SPECIALI	111	2072D46	DISSIPATORE	7
947	DISSIPATORE	18	1209	PROFILI SPECIALI	111	2073	DISSIPATORE	9
948	DISSIPATORE	18	1210	PROFILI SPECIALI	111	2073D70	DISSIPATORE	8
950	DISSIPATORE	19	1211	PROFILI SPECIALI	111	2074	DISSIPATORE	7
951	DISSIPATORE	8	1212	PROFILI SPECIALI	111	2074D46	DISSIPATORE	7
952	DISSIPATORE	21	1213	PROFILI SPECIALI	111	2075	DISSIPATORE	7
953	PROFILI SPECIALI	97	1214	PROFILI SPECIALI	111	2076	DISSIPATORE	11
956	DISSIPATORE	16	1300	PROFILI SPECIALI	94	2077	PROFILI SPECIALI	101
958	DISSIPATORE	20	1302	PROFILI SPECIALI	94	2091	CONTENITORE ELETTRONICA	1
959	DISSIPATORE	12	1303	PROFILI SPECIALI	94	2096	PROFILI SPECIALI	118
960	DISSIPATORE	18	1306	PROFILI SPECIALI	94	2097	DISSIPATORE	59
961	DISSIPATORE	28	1308	PROFILI SPECIALI	94	2098	DISSIPATORE	56
962	DISSIPATORE	23	1309	PROFILI SPECIALI	94	2100	DISSIPATORE	5
963	DISSIPATORE	7	1312	PROFILI SPECIALI	94	2101	DISSIPATORE	62
965	DISSIPATORE	4	1313	PROFILI SPECIALI	94	2106	PROFILI RACLE	109
967	DISSIPATORE	13	1315	PROFILI SPECIALI	94	2111	PROFILI SPECIALI	118
968	DISSIPATORE	13	1321	PROFILI SPECIALI	94	2112	DISSIPATORE	8
969	DISSIPATORE	53	1322	PROFILI SPECIALI	94	2113	PROFILI RACLE	108
970	DISSIPATORE	10	1323	PROFILI SPECIALI	94	2115	DISSIPATORE	11
971	DISSIPATORE	11	1324	PROFILI SPECIALI	94	2116	DISSIPATORE	59
972	DISSIPATORE	4	1325	PROFILI SPECIALI	94	2119	DISSIPATORE	6
973	DISSIPATORE	19	1326	PROFILI SPECIALI	94	2120	PROFILI SPECIALI	109
974	DISSIPATORE	16	1328	PROFILI SPECIALI	94	2126	CONTENITORE ELETTRONICA	2
975	DISSIPATORE	4	1329	PROFILI SPECIALI	94	2127	PROFILI SPECIALI	118
976	DISSIPATORE	19	1330	PROFILI SPECIALI	94	2129	DISSIPATORE	6
977	DISSIPATORE	60	1333	PROFILI SPECIALI	94	2131	CONTENITORE ELETTRONICA	3
978	DISSIPATORE	10	1338	PROFILI SPECIALI	94	2134	DISSIPATORE	7
979	DISSIPATORE	23	1400	PROFILI RACLE	108	2136	PROFILI SPECIALI	96
980	DISSIPATORE	25	1403	PROFILI RACLE	108	2139	DISSIPATORE	5
981	DISSIPATORE	25	1404	PROFILI RACLE	108	2142	DISSIPATORE	5
982	DISSIPATORE	26	1405	PROFILI RACLE	108	2144	DISSIPATORE	5
983/N	DISSIPATORE	11	1407	PROFILI RACLE	108	2148	DISSIPATORE	11
984	DISSIPATORE	17	1408	PROFILI RACLE	108	2153	DISSIPATORE	12
985	DISSIPATORE	12	1409	PROFILI RACLE	108	2154	CONTENITORE ELETTRONICA	3
986	DISSIPATORE	26	1412	PROFILI RACLE	108	2155	DISSIPATORE	23
987	DISSIPATORE	26	1413	PROFILI RACLE	108	2156	CONTENITORE ELETTRONICA	2
988	DISSIPATORE	27	1416	PROFILI RACLE	108	2158	DISSIPATORE	7
989	DISSIPATORE	27	1417	PROFILI RACLE	108	2160	PROFILI SPECIALI	102
990	DISSIPATORE	27	1418	PROFILI RACLE	109	2161	PROFILI SPECIALI	99
991	DISSIPATORE	27	1419	PROFILI RACLE	109	2163	PROFILI RACLE	109
992	DISSIPATORE	25	1420	PROFILI RACLE	108	2165	PROFILI SPECIALI	99
993	DISSIPATORE	26	1421	PROFILI RACLE	109	2170	DISSIPATORE	12
994	DISSIPATORE	22	1422	PROFILI RACLE	109	2176	DISSIPATORE	8
996	DISSIPATORE	21	1424	PROFILI SPECIALI	108	2181	DISSIPATORE	7
997	DISSIPATORE	9	1425	PROFILI SPECIALI	109	2183	PROFILI SPECIALI	99
998	DISSIPATORE	15	1429	PROFILI RACLE	108	2187	CONTENITORE ELETTRONICA	2
999	DISSIPATORE	12	1621	PROFILI SPECIALI	95	2193	DISSIPATORE	10
1000	PROFILI STAND	64	1824	PROFILI SPECIALI	95	2196	DISSIPATORE	4
1001	PROFILI STAND	64	2003	PROFILI SPECIALI	105	2197	DISSIPATORE	9
1002	PROFILI STAND	64	2005	CONTENITORE ELETTRONICA	3	2198	DISSIPATORE	5
1005	PROFILI STAND	64	2012	PROFILI SPECIALI	113	2200	PROFILI PNEUMATICI	107
1008	PROFILI STAND	64	2015	PROFILI RACLE	108	2202	DISSIPATORE	6
1013	PROFILI STAND	64	2017	DISSIPATORE	55	2203	DISSIPATORE	52
1100	PROFILI SPECIALI	112	2019	PROFILI SPECIALI	107	2210	DISSIPATORE	52
1101	PROFILI SPECIALI	112	2021	PROFILI SPECIALI	97	2212	PROFILI COM PONIBILI	70
1102	PROFILI SPECIALI	112	2022	PROFILI SPECIALI	97	2216	DISSIPATORE	5
1103	PROFILI SPECIALI	112	2024	PROFILI SPECIALI	97	2219	DISSIPATORE	4
1104	PROFILI SPECIALI	112	2028	CONTENITORE ELETTRONICA	2	2227	DISSIPATORE	60
1105	PROFILI SPECIALI	112	2031	PROFILI RACLE	108	2228	DISSIPATORE	97
1106	PROFILI SPECIALI	112	2036	DISSIPATORE	5	2230	PROFILI SPECIALI	101
1107	PROFILI SPECIALI	112	2040	PROFILI SPECIALI	99	2232	CONTENITORE ELETTRONICA	1
1108	PROFILI SPECIALI	112	2041	PROFILI COM PONIBILI	72	2235	DISSIPATORE	11
1109	PROFILI SPECIALI	112	2042	PROFILI COM PONIBILI	72	2243	PROFILI COM PONIBILI	66
1110	PROFILI SPECIALI	112	2043	PROFILI COM PONIBILI	72	2248	DISSIPATORE	4

Via Newton, n.12
20016 Pero (Milano - Italy)
Tel.+39 02 3535955 r.a. Fax.+39 02 3539929
E-Mail: info@omar-alluminio.it

Cataloghi Online: www.omar-alluminio.it
www.omar-alluminio.com

PROFILATI ALLUMINIO A DISEGNO / STANDARD / SPECIALI / E PER:
ELETTRONICA / LED / FOTOVOLTAICO / AUTOMAZIONE ROBOTICA / PNEUMATICA / AUTOMOTIVE



Via Newton, n.12
20016 Pero (Milano - Italy)
Tel. +39 02 3535955 r.a. Fax. +39 02 3539929
E-Mail: info@omar-alluminio.it

Cataloghi Online: www.omar-alluminio.it
www.omar-alluminio.com
PROFILATI ALLUMINIO A DISEGNO / STANDARD / SPECIALI / E PER:
ELETTRONICA / LED / FOTOVOLTAICO / AUTOMAZIONE ROBOTICA / PNEUMATICA / AUTOMOTIVE



Indice Articoli

Consultate il Catalogo aggiornato Online
all'indirizzo www.omar-alluminio.it

2249	DISSIPATORE	22	3019	PROFILI SPECIALI	99	3102	PROFILI SPECIALI	96
2254	DISSIPATORE	60	3020	PROFILI SPECIALI	107	3103	PROFILI SPECIALI	97
2258	PROFILI SPECIALI	112	3021	PROFILI SPECIALI	107	3104	PROFILI SPECIALI	96
2260	DISSIPATORE	8	3022	PROFILI SPECIALI	107	3105	PROFILI SPECIALI	96
2266	DISSIPATORE	6	3024	PROFILI SPECIALI	107	3106	PROFILI SPECIALI	96
2271	DISSIPATORE	55	3026/N	PROFILI SPECIALI	102	3107	PROFILI SPECIALI	96
2273	DISSIPATORE	5	3027/N	PROFILI SPECIALI	102	3108	PROFILI SPECIALI	96
2274	DISSIPATORE	54	3028	PROFILI SPECIALI	102	3109	PROFILI SPECIALI	96
2277	PROFILI SPECIALI	103	3029	PROFILI SPECIALI	96	3110	PROFILI SPECIALI	97
2278	DISSIPATORE	6	3030	PROFILI SPECIALI	96	3111	PROFILI SPECIALI	97
2279	PROFILI SPECIALI	118	3031	PROFILI SPECIALI	96	3112	PROFILI SPECIALI	96
2298	DISSIPATORE	5	3032	PROFILI SPECIALI	96	3113	PROFILI SPECIALI	96
2300	PROFILI PNEUMATICA	90	3033	PROFILI SPECIALI	96	3114	PROFILI SPECIALI	96
2318	PROFILI SPECIALI	105	3034	PROFILI SPECIALI	96	3115	PROFILI SPECIALI	97
2320	PROFILI SPECIALI	107	3035	PROFILI SPECIALI	107	3116	PROFILI SPECIALI	97
2321	PROFILI SPECIALI	105	3036	PROFILI SPECIALI	101	3117	PROFILI SPECIALI	118
2322	PROFILI SPECIALI	105	3037	PROFILI SPECIALI	101	3118	PROFILI SPECIALI	97
2323	PROFILI SPECIALI	105	3043	PROFILI SPECIALI	106	3119	PROFILI SPECIALI	97
2324	PROFILI SPECIALI	105	3044	PROFILI SPECIALI	105	3120	PROFILI SPECIALI	97
2325	PROFILI SPECIALI	106	3045	PROFILI SPECIALI	106	3121	PROFILI SPECIALI	97
2326	PROFILI SPECIALI	105	3046	PROFILI SPECIALI	106	3122	PROFILI SPECIALI	97
2327	PROFILI SPECIALI	105	3048	PROFILI SPECIALI	102	3123	PROFILI SPECIALI	97
2328	PROFILI SPECIALI	105	3050	PROFILI SPECIALI	102	3124/N	PROFILI SPECIALI	97
2329	PROFILI SPECIALI	105	3051	PROFILI SPECIALI	98	3125	PROFILI SPECIALI	99
2331	PROFILI SPECIALI	105	3052	PROFILI SPECIALI	98	3126	PROFILI SPECIALI	97
2332	PROFILI SPECIALI	105	3053	PROFILI SPECIALI	98	3127	PROFILI SPECIALI	118
2333	PROFILI SPECIALI	105	3054	PROFILI SPECIALI	98	3128	PROFILI SPECIALI	97
2334	PROFILI SPECIALI	105	3055	PROFILI SPECIALI	98	3129/N	PROFILI SPECIALI	99
2335	PROFILI SPECIALI	105	3056	PROFILI SPECIALI	98	3130	PROFILI SPECIALI	97
2336	PROFILI SPECIALI	105	3057	PROFILI SPECIALI	98	3131	PROFILI SPECIALI	97
2338	PROFILI SPECIALI	105	3058	PROFILI SPECIALI	98	3132	PROFILI SPECIALI	99
2339	PROFILI SPECIALI	105	3059	PROFILI SPECIALI	98	3133	PROFILI SPECIALI	101
2340	PROFILI SPECIALI	105	3060	PROFILI SPECIALI	98	3134	PROFILI SPECIALI	101
2341	PROFILI SPECIALI	105	3061	PROFILI SPECIALI	98	3135	PROFILI SPECIALI	101
2342	PROFILI SPECIALI	106	3062	PROFILI SPECIALI	98	3137	PROFILI SPECIALI	99
2343	PROFILI SPECIALI	106	3063	PROFILI SPECIALI	98	3138	PROFILI SPECIALI	99
2344	PROFILI SPECIALI	105	3064	PROFILI SPECIALI	101	3140	PROFILI SPECIALI	101
2345	PROFILI SPECIALI	105	3065	PROFILI SPECIALI	98	3141/N	PROFILI SPECIALI	96
2346	PROFILI SPECIALI	105	3066	PROFILI SPECIALI	98	3142	PROFILI SPECIALI	107
2347	PROFILI SPECIALI	105	3067	PROFILI SPECIALI	101	3143	PROFILI SPECIALI	96
2348	PROFILI SPECIALI	105	3068	PROFILI SPECIALI	98	3144	PROFILI SPECIALI	96
2349	PROFILI SPECIALI	105	3069	PROFILI SPECIALI	101	3145	PROFILI SPECIALI	107
2350	PROFILI SPECIALI	105	3070	PROFILI SPECIALI	101	3146	PROFILI SPECIALI	107
2351	PROFILI SPECIALI	105	3071	PROFILI SPECIALI	101	3147	PROFILI SPECIALI	112
2352	PROFILI SPECIALI	105	3072	PROFILI SPECIALI	98	3148	PROFILI SPECIALI	102
2353	PROFILI SPECIALI	105	3073	PROFILI SPECIALI	98	3149	PROFILI SPECIALI	102
2354	PROFILI SPECIALI	107	3074	PROFILI SPECIALI	98	3150	PROFILI SPECIALI	102
2355	PROFILI SPECIALI	107	3075	PROFILI SPECIALI	98	3151	PROFILI SPECIALI	102
2356	PROFILI SPECIALI	107	3076	PROFILI SPECIALI	98	3152	PROFILI SPECIALI	97
2357	PROFILI SPECIALI	105	3077	PROFILI SPECIALI	99	3153	PROFILI SPECIALI	99
2358	PROFILI SPECIALI	105	3078	PROFILI SPECIALI	99	3154	PROFILI SPECIALI	99
2448	CONTENITORE ELETTRONICA	1	3079	PROFILI SPECIALI	99	3155	PROFILI SPECIALI	99
2496	CONTENITORE ELETTRONICA	1	3080	PROFILI SPECIALI	99	3156	PROFILI SPECIALI	95
3000	PROFILI STAND	64	3081/N	PROFILI SPECIALI	99	3159	PROFILI SPECIALI	112
3001	PROFILI SPECIALI	105	3082/N	PROFILI SPECIALI	97	3160	PROFILI SPECIALI	102
3002	PROFILI SPECIALI	96	3083	PROFILI SPECIALI	113	3161	PROFILI SPECIALI	102
3003	PROFILI SPECIALI	105	3084	PROFILI SPECIALI	113	3162	PROFILI SPECIALI	95
3004	PROFILI SPECIALI	105	3085	PROFILI SPECIALI	113	3163	PROFILI SPECIALI	99
3004-1	PROFILI SPECIALI	105	3086	PROFILI SPECIALI	113	3164	PROFILI SPECIALI	97
3005	PROFILI SPECIALI	101	3087	PROFILI SPECIALI	113	3165	PROFILI SPECIALI	99
3006	PROFILI SPECIALI	107	3088	PROFILI SPECIALI	113	3166	PROFILI SPECIALI	99
3007	PROFILI SPECIALI	107	3089	PROFILI SPECIALI	113	3167	PROFILI SPECIALI	102
3008	PROFILI SPECIALI	107	3090	PROFILI SPECIALI	113	3168	PROFILI SPECIALI	97
3010	PROFILI SPECIALI	101	3091	PROFILI SPECIALI	113	3169	PROFILI SPECIALI	99
3011	PROFILI SPECIALI	101	3092	PROFILI SPECIALI	113	3170	PROFILI SPECIALI	98
3012	PROFILI SPECIALI	101	3093	PROFILI SPECIALI	113	3171	PROFILI SPECIALI	96
3014	PROFILI SPECIALI	101	3097	DISSIPATORE	5	3172	PROFILI SPECIALI	102
3015	PROFILI SPECIALI	101	3098	PROFILI SPECIALI	96	3173	PROFILI SPECIALI	97
3016	PROFILI SPECIALI	96	3099	PROFILI SPECIALI	96	3174	PROFILI SPECIALI	99
3017	PROFILI SPECIALI	107	3100	PROFILI SPECIALI	97	3175	PROFILI SPECIALI	99
3018	PROFILI SPECIALI	104	3101	PROFILI SPECIALI	96	3177	PROFILI SPECIALI	96

Consultate il Catalogo aggiornato Online
all'indirizzo www.omar-alluminio.it

Indice Articoli

3178	PROFILI SPECIALI	97	3261	PROFILI SPECIALI	98	96192	CONTENITORE ELETTRONICA	2
3179	PROFILI SPECIALI	97	3262	PROFILI SPECIALI	98	PNC100	PROFILI PNEUMATICI	87
3180	PROFILI SPECIALI	99	3263	PROFILI SPECIALI	98	PNC25	PROFILI PNEUMATICI	87
3181	PROFILI SPECIALI	99	3264	PROFILI SPECIALI	98	PNC32	PROFILI PNEUMATICI	87
3182	PROFILI SPECIALI	101	3265	PROFILI SPECIALI	101	PNC40	PROFILI PNEUMATICI	87
3184	PROFILI SPECIALI	101	3266	PROFILI SPECIALI	98	PNC50	PROFILI PNEUMATICI	87
3185	PROFILI SPECIALI	96	3267	PROFILI SPECIALI	98	PNC63	PROFILI PNEUMATICI	87
3187	PROFILI SPECIALI	107	3269	PROFILI SPECIALI	98	PNC80	PROFILI PNEUMATICI	87
3188	PROFILI SPECIALI	96	3270	PROFILI SPECIALI	105	PNCT100	PROFILI PNEUMATICI	88
3189/N	PROFILI SPECIALI	99	3271	PROFILI RACLE	113	PNCT25	PROFILI PNEUMATICI	88
3190	PROFILI SPECIALI	106	3272	PROFILI RACLE	113	PNCT32	PROFILI PNEUMATICI	88
3191	PROFILI SPECIALI	99	3307	PROFILI SPECIALI	101	PNCT40	PROFILI PNEUMATICI	88
3192	PROFILI SPECIALI	106	3308	PROFILI SPECIALI	113	PNCT50	PROFILI PNEUMATICI	88
3193	PROFILI SPECIALI	99	3309	PROFILI SPECIALI	113	PNCT63	PROFILI PNEUMATICI	88
3194	PROFILI SPECIALI	99	3310	PROFILI SPECIALI	97	PNCT80	PROFILI PNEUMATICI	88
3195	PROFILI SPECIALI	99	3311	PROFILI SPECIALI	103	PNLG100	PROFILI PNEUMATICI	89
3197	PROFILI SPECIALI	99	3312	PROFILI SPECIALI	103	PNLG125	PROFILI PNEUMATICI	89
3199	PROFILI SPECIALI	99	3313	PROFILI SPECIALI	103	PNLG32	PROFILI PNEUMATICI	89
3200	PROFILI SPECIALI	114	3314	PROFILI SPECIALI	108	PNLG40	PROFILI PNEUMATICI	89
3201	PROFILI SPECIALI	114	3315	PROFILI SPECIALI	103	PNLG50	PROFILI PNEUMATICI	89
3202	PROFILI SPECIALI	97	3316	PROFILI SPECIALI	103	PNLG63	PROFILI PNEUMATICI	89
3203	PROFILI SPECIALI	102	3317	PROFILI SPECIALI	103	PNLG80	PROFILI PNEUMATICI	89
3204	PROFILI SPECIALI	102	3318	PROFILI SPECIALI	104	PNM80100	PROFILI PNEUMATICI	79
3205	PROFILI SPECIALI	102	3319	PROFILI SPECIALI	106	PNM80125	PROFILI PNEUMATICI	79
3209	PROFILI SPECIALI	102	3320	PROFILI SPECIALI	106	PNM8020	PROFILI PNEUMATICI	79
3210	PROFILI SPECIALI	102	3321	PROFILI SPECIALI	106	PNM8025	PROFILI PNEUMATICI	79
3211	PROFILI SPECIALI	102	3322	PROFILI SPECIALI	106	PNM8032	PROFILI PNEUMATICI	79
3212	PROFILI SPECIALI	102	3323	PROFILI SPECIALI	106	PNM8040	PROFILI PNEUMATICI	79
3213	PROFILI SPECIALI	102	3324	PROFILI SPECIALI	106	PNM8050	PROFILI PNEUMATICI	79
3214	PROFILI SPECIALI	102	3325	PROFILI SPECIALI	106	PNM8063	PROFILI PNEUMATICI	79
3215	PROFILI SPECIALI	96	3326	PROFILI SPECIALI	106	PNM8080	PROFILI PNEUMATICI	79
3216	PROFILI SPECIALI	99	3327	PROFILI SPECIALI	98	PNM89100	PROFILI PNEUMATICI	82
3217	PROFILI SPECIALI	97	3328	PROFILI SPECIALI	98	PNM89125	PROFILI PNEUMATICI	82
3218	PROFILI SPECIALI	96	3329	PROFILI SPECIALI	98	PNM89160	PROFILI PNEUMATICI	83
3219	PROFILI SPECIALI	96	3330	PROFILI SPECIALI	98	PNM89200	PROFILI PNEUMATICI	83
3220	PROFILI SPECIALI	97	3332	PROFILI SPECIALI	98	PNM8932	PROFILI PNEUMATICI	81
3221	PROFILI SPECIALI	95	3333	PROFILI SPECIALI	99	PNM8940	PROFILI PNEUMATICI	81
3222	PROFILI SPECIALI	95	3334	PROFILI SPECIALI	106	PNM8950	PROFILI PNEUMATICI	81
3223	PROFILI SPECIALI	95	3335	PROFILI SPECIALI	105	PNM8963	PROFILI PNEUMATICI	81
3224	PROFILI SPECIALI	95	3336	PROFILI SPECIALI	104	PNM8980	PROFILI PNEUMATICI	81
3225	PROFILI SPECIALI	95	3337	PROFILI SPECIALI	99	PNM90100	PROFILI PNEUMATICI	80
3226	PROFILI SPECIALI	96	3338	PROFILI SPECIALI	99	PNM9032	PROFILI PNEUMATICI	80
3227	PROFILI SPECIALI	107	3339	PROFILI SPECIALI	103	PNM9040	PROFILI PNEUMATICI	80
3229	PROFILI SPECIALI	118	3340	PROFILI SPECIALI	104	PNM9050	PROFILI PNEUMATICI	80
3230	PROFILI SPECIALI	96	3341	TENDE PER INTERNI	116	PNM9063	PROFILI PNEUMATICI	80
3231	PROFILI SPECIALI	101	3342	TENDE PER INTERNI	116	PNM9080	PROFILI PNEUMATICI	80
3232	PROFILI SPECIALI	99	3343	TENDE PER INTERNI	116	PNP94100	PROFILI PNEUMATICI	85
3234	PROFILI SPECIALI	113	3344	TENDE PER INTERNI	116	PNP9416	PROFILI PNEUMATICI	85
3235	PROFILI SPECIALI	113	3345	TENDE PER INTERNI	116	PNP9420	PROFILI PNEUMATICI	85
3236	PROFILI SPECIALI	113	3346	TENDE PER INTERNI	116	PNP9425	PROFILI PNEUMATICI	85
3237	PROFILI SPECIALI	96	3347	TENDE PER INTERNI	116	PNP9432	PROFILI PNEUMATICI	85
3238	PROFILI SPECIALI	96	3348	TENDE PER INTERNI	116	PNP9440	PROFILI PNEUMATICI	85
3239	PROFILI SPECIALI	99	3349	TENDE PER INTERNI	116	PNP9450	PROFILI PNEUMATICI	85
3240	PROFILI SPECIALI	98	3350	TENDE PER INTERNI	116	PNP9463	PROFILI PNEUMATICI	85
3241	PROFILI SPECIALI	98	3351	TENDE PER INTERNI	117	PNP9480	PROFILI PNEUMATICI	85
3242	PROFILI SPECIALI	98	3354	TENDE PER INTERNI	117	PNR99100	PROFILI PNEUMATICI	84
3243	PROFILI SPECIALI	98	3355	TENDE PER INTERNI	117	PNR99125	PROFILI PNEUMATICI	84
3245	PROFILI SPECIALI	98	3356	TENDE PER INTERNI	117	PNR9932	PROFILI PNEUMATICI	84
3246	PROFILI SPECIALI	98	3357	TENDE PER INTERNI	117	PNR9940	PROFILI PNEUMATICI	84
3247	PROFILI SPECIALI	98	3358	TENDE PER INTERNI	117	PNR9950	PROFILI PNEUMATICI	84
3248	PROFILI SPECIALI	98	3359	TENDE PER INTERNI	117	PNR9963	PROFILI PNEUMATICI	84
3249	PROFILI SPECIALI	98	3672	CONTENITORE ELETTRONICA	1	PNR9980	PROFILI PNEUMATICI	84
3250	PROFILI SPECIALI	98	3696	CONTENITORE ELETTRONICA	1	PNT100106	PROFILI PNEUMATICI	86
3251	PROFILI SPECIALI	105	4848	CONTENITORE ELETTRONICA	1	PNT100107	PROFILI PNEUMATICI	86
3252	PROFILI SPECIALI	98	4896	CONTENITORE ELETTRONICA	1	PNT105110	PROFILI PNEUMATICI	86
3253	PROFILI SPECIALI	98	7272	CONTENITORE ELETTRONICA	1	PNT1216	PROFILI PNEUMATICI	86
3254	PROFILI SPECIALI	106	9696	CONTENITORE ELETTRONICA	1	PNT125131	PROFILI PNEUMATICI	86
3256	PROFILI SPECIALI	106	36144	CONTENITORE ELETTRONICA	1	PNT125132	PROFILI PNEUMATICI	86
3257	PROFILI SPECIALI	98	48192	CONTENITORE ELETTRONICA	2	PNT150160	PROFILI PNEUMATICI	86
3259	PROFILI SPECIALI	98	50144	CONTENITORE ELETTRONICA	1	PNT160167	PROFILI PNEUMATICI	86
3260	PROFILI SPECIALI	98	72144	CONTENITORE ELETTRONICA	1	PNT160170	PROFILI PNEUMATICI	86

Tipo di matrici di estrusione

Extrusion tools

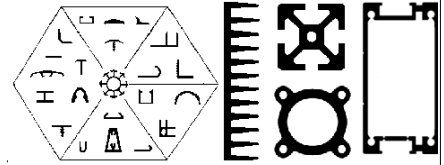

A) matrice piana per
profilato aperto

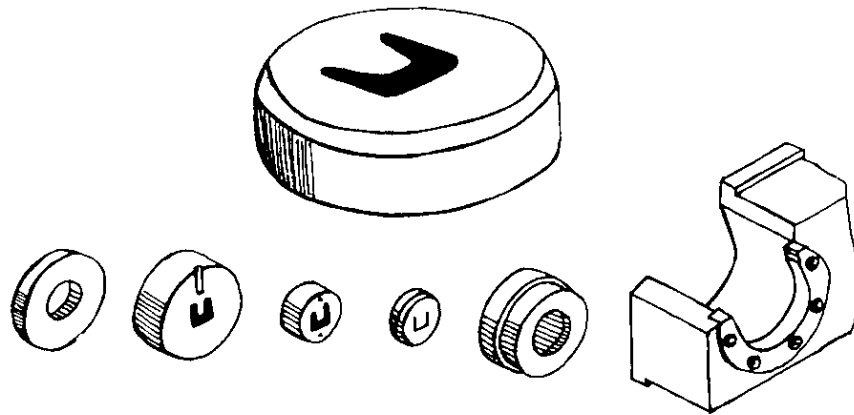

B) matrice Spyder per
profilato cavo

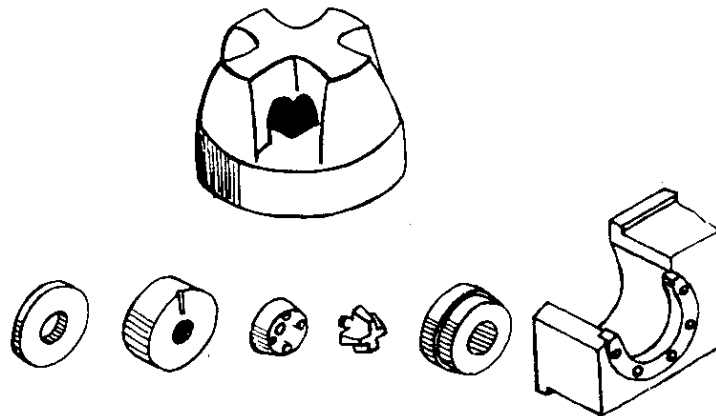

C) matrice Porthole
per profilato cavo

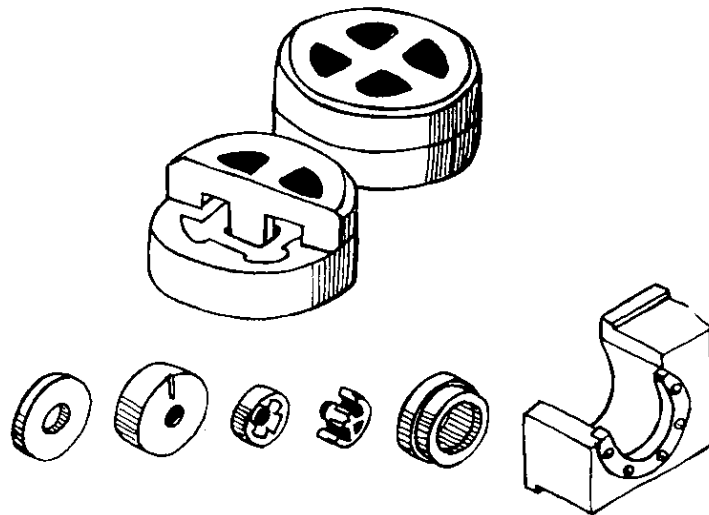

D) matrice a Ponte simile
a Porthole per profilato cavo

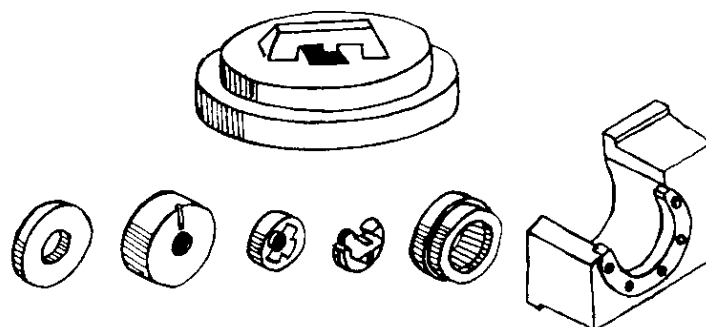

Via Newton, n.12

20016 Pero (Milano - Italy)

Tel. +39 02 3535955 r.a. Fax. +39 02 3539929

E-Mail: info@omar-alluminio.it

Cataloghi Online: www.omar-alluminio.it

www.omar-alluminio.com

PROFILATI ALLUMINIO A DISEGNO / STANDARD / SPECIALI / E PER:

ELETTRONICA / LED / FOTOVOLTAICO / AUTOMAZIONE ROBOTICA / PNEUMATICA / AUTOMOTIVE

OMAR s.r.l.
PROFILATI ALLUMINIO
ALTA TECNOLOGIA



- DIMENSIONI MASSIME ESTRUDIBILI -

SCALA 1:3

470

330

R145

R90

PRESSA 3200 TON

PRESSA 6050 TON

450

630

Cataloghi Online: www.omar-alluminio.it

www.omar-alluminio.com

PROFILATI ALLUMINIO A DISEGNO / STANDARD / SPECIALI / E PER:

ELETTRONICA / LED / FOTOVOLTAICO / AUTOMAZIONE ROBOTICA / PNEUMATICA / AUTOMOTIVE

Via Newton, n.12

20016 Pero (Milano - Italy)

Tel. +39 02 3535955 r.a. Fax. +39 02 3539929

E-Mail: info@omar-alluminio.it

OMAR s.r.l.
PROFILATI ALLUMINIO
ALTA TECNOLOGIA

Principali leghe da estrusione

Extrusion aluminium alloy properties

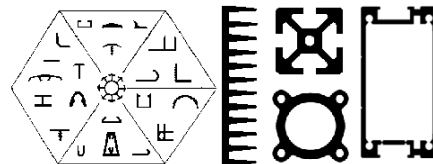

LEGA DI ALLUMINIO DA ESTRUSIONE EN AW-6060

La lega EN AW 6060 è lega da estrusione più diffusa sul mercato europeo, per le sue doti di alta velocità di deformazione a caldo.

Essa consente la realizzazione di profilati con sezione anche complessa, comprendente cavità e scanalature, per avvicinare quanto più possibile il disegno dell'estruso a quello del manufatto finito, e ridurre al minimo le lavorazioni intermedie.

Essa inoltre presenta ottima resistenza alla corrosione ambientale, anche in atmosfera industriale e marina.

Caratteristiche fisiche

Massa volumica	2,70	Gr/cm3	Conducibilità termica a 20°C	Nello stato 0: 2,09 W/cm °Kelvin Nello stato T6: 1,75 W/cm °Kelvin
Punto di fusione inferiore	605	C	Coeff. Di dilatazione termica lineare	Tra 20° e 100°C: 23,0 -10-6 1°/Kelvin Tra 20° e 200°C: 24,0 -10-6 1°/Kelvin Tra 20° e 300°C: 25,0 -10-6 1°/Kelvin
Calore specifico tra 0° e 100°C	890	Joule/Kg °Kelvin	Resistività elettrica a 20°C	Nello stato 0: 3,14 microOhm *cm Nello stato T6: 3,25 microOhm *cm
Modulo di elasticità lineare E	69000	Newton/mm2		
Modulo di elasticità tangenziale G	26000	Newton/mm2		

Tipo profilo	(1) stato fisico di fornitura	Diametro D		Carico	Di rottura a	Carico di	Rottura a	Allungamento			
		o spess. S	[mm] per tonde,					Trazione	Rm [Mpa]	A %	A50 mm%
		o spess. Di parete	[mm] per barre,					min	max	min	max
tondi e barre piane	T4 (*)	D ≤150	S ≤150	120	-	60	-	16	14		
	T5	D ≤150	S ≤150	160	-	120	-	8	6		
	T6 (*)	D ≤150	S ≤150	190	-	150	-	8	6		
	T64 (*)	D ≤50	S ≤50	180	-	120	-	12	10		
	T66 (*)	D ≤150	S ≤150	215	-	160	-	8	6		
tubi	T4(*)	e ≤15		120	-	60	-	16	14		
	T5	e ≤15		160	-	120	-	8	6		
	T6(*)	e ≤15		190	-	150	-	8	6		
	T64(*)	e ≤15		180	-	120	-	12	10		
	T66(*)	e ≤15		215	-	160	-	8	6		
Profili aperti e cavi	T4 (*)	e ≤25		120	-	60	-	16	14		
	T5	e ≤5		160	-	120	-	8	6		
		5 < e ≤ 25		140	-	100	-	8	6		
	T6 (*)	e ≤3		190	-	150	-	8	6		
		3 < e ≤ 25		170	-	140	-	8	6		
	T66 (*)	e ≤3		215	-	160	-	8	6		
		3 < e ≤ 25		195	-	150	-	8	6		

LEGA	Stato fisico	Deformabilità plastica		Lavorabilità su macchina utensile	Saldabilità	Lucidabilità	Ossidazione	anodica		Resistenza alla corrosione		
		a freddo	a caldo					protettiva	decorativa	urbana	industriale	marina
EN AW-3103	F,H 112	2	1	5	3	4	3	3	1	1	2	
	O,H 111	2	1	5	3	4	3	3	1	1	2	
EN AW-6060	O	2	1	5	2	4	1	2	1	2	2	
	T1,T4	3	2	4	2	3	1	1	1	2	2	
	T5,T6	4	X	3	2	2	1	1	1	2	2	
EN AW-6063	O,H 111	2	1	5	2	4	1	2	2	2	3	
	T4	3	2	4	2	3	1	1	2	2	3	
	T5,T6	4	X	3	2	2	1	1	2	2	3	
EN AW-6005A	O	2	1	4	2	3	2	4	2	3	3	
	T4	3	2	3	2	2	2	3	2	3	3	
	T5,T6	4	X	2	2	1	2	3	2	3	3	
EN AW-6082	O,H 111	2	1	4	2	3	2	3	3	3	3	
	T4	3	2	3	2	2	2	2	3	3	3	
	T5,T6	4	X	2	2	1	2	2	3	3	3	

INDICE DI VALUTAZIONE: 1=OTTIMO 2=BUONO 3=SUFFICIENTE 4=MEDIOCRE 5=SCARSO X=NON APPLICABILE AGLI STATI T5 E T6

Via Newton, n.12

20016 Pero (Milano - Italy)

Tel. +39 02 3535955 r.a. Fax. +39 02 3539929

E-Mail: info@omar-alluminio.it

Cataloghi Online: www.omar-alluminio.it

www.omar-alluminio.com

PROFILATI ALLUMINIO A DISEGNO / STANDARD / SPECIALI / E PER:

ELETTRONICA / LED / FOTOVOLTAICO / AUTOMAZIONE ROBOTICA / PNEUMATICA / AUTOMOTIVE



FIERA MILANO RHO - PERO

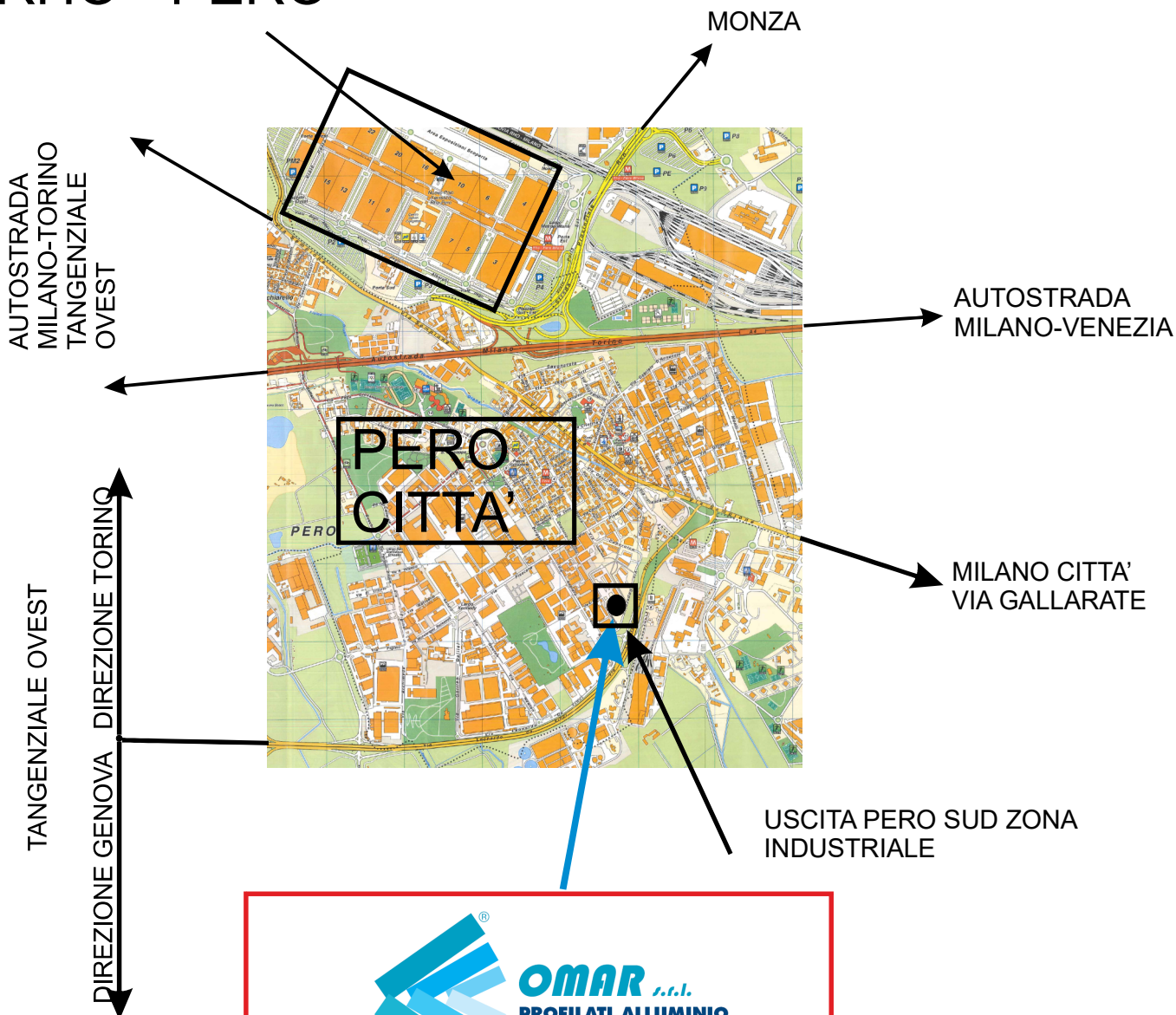

OMAR s.r.l.
PROFILATI ALLUMINIO
ALTA TECNOLOGIA

Via Newton, n.12
20016 Pero (Milano - Italy)
Tel.+39 02 3535955 r.a.
Fax.+39 02 3539929
E.Mail: info@omar-alluminio.it

Consultate il ns. catalogo aggiornato online all'indirizzo:

www.omar-alluminio.it
www.omar-alluminio.com
www.omar-alluminio.eu

PROFILATI IN ALLUMINIO
A DISEGNO-STANDARD-SPECIALI



E PER: ELETTRONICA-LED-FOTOVOLTAICO
AUTOMAZIONE ROBOTICA-PNEUMATICA-AUTOMOTIVE